

 **TRIO**
LIGHTING FOR YOU



23 | 24



CATALOGUE
2023 / 2024



Intelligente Lichtsteuerung · smart lighting control

42 - 57

contrôle d'éclairage intelligent · slimme lichtregeling ·
control de iluminación inteligente · controllo intelligente dell'illuminazione ·
control inteligent al iluminatului · älykäs valaistuksen ohjaus ·
Inteligentne sterowanie światłem



Leuchtenfamilien & Kombinationen · Families & coordinates

58 - 161

Familles & coordonnés · Families & combinaties · Familias & coordinados ·
Famiglie & coordinati · Famillii & Coordonate ·
Tuoteperheet & yhdistettävät tuotteet · Rodzinne orawy & kombinacje

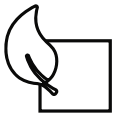

Natur & Design · Nature & Design

162- 213

Nature et design · Natuur en design ·
Naturalidad & Diseño · Natura e design · Natură și design ·
Luonto ja suunnittelu · Naturalność i dizajn

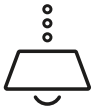

Pendelleuchten & Kronen · Pendants & chandeliers

214- 261

Lustres & suspensions · Hanglampen & kroonluchters ·
Colgantes y Lámparas · Lampadari e sospensioni · Lustre si pendule ·
Riippu- & kruunu · Wiszące i żyrandole



Wand- und Deckenleuchten · Wall & Ceiling lamps

262-375

Applique & plafonniers · Wandlampen & plafonnières ·
Appliques y plafones · Applique e plafoniere · Plafoniere si aplice ·
Seinä- & katto · Sufitowe i ścienne

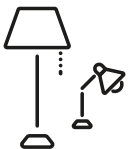

Steh- und Tischleuchten · Table- & floor lamps

376-449

Lampes de table & lampadaires · Tafel- & vloerlampen ·
Sobremesas y lámparas de pie · Lampade da tavolo e piantane ·
Veioze si lampadare · Pöytä- & lattia · Stołowe i podłogowe

INHALTSVERZEICHNIS

General Index · Index général · Algemene index ·
Índice general · Indice generale · Index general · Yleisindeksi · Ogólny indeks



Spotserien · Spots

450 - 477

Spotterie · Spots · Focos · Faretti · Spoturi · Spotit · Reflektorki

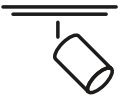

DUOline Schienensystem (230 V) · track system (230 V)

478-501

Système de voie à deux phases (230 V) · 2-fase-spoorsysteem (230 V) ·
Sistema de rieles en 2 fases (230 V) · Sistema a binario bifase (230 V) ·
Sistem de piste cu 2 faze (230 V) · 2-vaihekiskojärjestelmä (230 V) ·
2-fazowy system prowadnic (230 V)



Einbauleuchten · Recessed spots

502 - 515

Spots encastrés · Inbouwspots · Focos empotrables ·
Faretti incasso · Spoturi incastrate · Uputetut spotit · Oprawy wbudowane

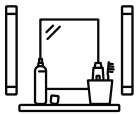

Badezimmerleuchten · Bathroom lighting

516-551

Éclairage salle de bains · Badkamer verlichting ·
Iluminación de cuarto de baño · Illuminazione per bagno ·
Iluminat baie · Kylpyhuone valaistus · Oświetlenie łazienkowe



Leuchtmittel · Light sources

552 - 563

Ampoules · Lichtbronnen · Fuentes de luz ·
Lampadine · Becuri · Valonlähteet · Źródła światła



Spezifikationen · Specifications

574-587

Spécifications · Specificaties · Especificaciones ·
Specifiche · Specificații · Tekniset tiedot · Specyfikacje



Kontakte · Contact

604 - 605

Contact · Contact · Contactar ·
Contatto · Contact · Yhteydenotto · Kontakt

LIGHTING FOR YOU

Ⓓ

Liebe Kund*innen und Geschäftspartner*innen,
eine Wohnumgebung in der man sich wohlfühlt, ist ein
Stück Lebensqualität!

Unsere neuesten Leuchten-Trends zeigen, wie Wohnbe-
reiche individuell gestaltet und anspruchsvoll ausgeleuch-
tet werden können. Ob klassisch oder modern, warm und
natürlich, puristisch oder glamourös – lassen Sie sich
inspirieren!

Viel Vergnügen beim Durchstöbern unseres neuen
Kataloges!

ⒼⒷ

Dear customers and business partners,

A living environment in which you feel comfortable is a
piece of quality of life!

Our latest lighting trends show how living areas can be
individually designed and sophisticatedly illuminated.
Whether classic or modern, warm and natural, purist or
glamorous - let yourself be inspired!

Enjoy browsing through our new catalogue!

ⒻⓇ

Chers clients et partenaires commerciaux,

Un environnement de vie dans lequel vous vous sentez
confortable est une pièce de qualité de vie !

Nous dernières tendances d'éclairage montrent comment
les lieux de vie peuvent être individuellement conçus et
élégamment éclairés. Qu'il soit classique ou moderne,
chaleureux et naturel, puriste ou glamour - laissez-vous
inspiré !

Enjoy browsing through our new catalogue!

ⓃⓁ

Beste klanten en zakenpartners,

Een leefomgeving, waarin u zich comfortabel voelt, vormt
een stukje levenskwaliteit!

Onze nieuwste verlichtingstrends tonen hoe leefruimtes
individueel ontworpen en verfijnd verlicht kunnen
worden. Of het nu klassiek of modern, warm en natuurlijk,
purist of betoverend is - laat inspireren!

Geniet van grasduinen doorheen onze nieuwe catalogus!





(ES)

Queridos clientes y socios,

¡un ambiente en el que se sientan cómodos es parte vital de la calidad de vida!

Nuestras últimas tendencias en iluminación muestran como se pueden diseñar individualmente los ambientes e iluminarlos de forma sofisticada. Ya sea de forma clásica o moderna, cálida y natural, purista o glamorosa - ¡inspírate!

¡Disfruta de nuestro nuevo catálogo!

(IT)

Cari clienti e partner commerciali,

Un ambiente in cui ci si sente a proprio agio è un componente essenziale della qualità della vita!

Le nostre ultime tendenze in fatto di illuminazione mostrano come gli spazi abitativi possano essere progettati in modo personalizzato e illuminati in modo sofisticato. Classico o moderno, caldo e naturale, purista o glamour: lasciatevi ispirare!

Divertitevi a sfogliare il nostro nuovo catalogo!

(RO)

Dragi clienți și parteneri de afaceri,

Un mediu de viață în care vă simțiți confortabil este parte de calitatea vieții!

Ultimele noaste tendințe în iluminat arată cum zonele de locuit pot fi proiectate individual și iluminate sofisticat. Clasic sau modern, cald și natural, purist sau fastuos - lăsați-vă inspirați!

Bucurați-vă răsfoind noul nostru catalog!

(FI)

Hyvät asiakkaat ja yhteistyökumppanit.

Asuinympäristö, jossa tunnet olosi mukavaksi, on osa elämänlaatua! Viimeisin valaistustrendimme näyttää, kuinka olohuoneet voidaan suunnitella yksilöllisesti ja valaista hienostuneesti. Klassista tai modernia, lämmintä ja luonnollista, vähäeleistä tai yllälistä - anna itsesi inspiroitua!

Nauti uuteen kuvastoomme tutustumisesta!

(PL)

Szanowni Klienci i Partnerzy Handlowi,

Mieszkanie, w którym czujemy się komfortowo, to element jakości życia!

Nasze najnowsze trendy oświetleniowe pokazują, jak można indywidualnie projektować i oświetlać pomieszczenia mieszkalne. Klasyczne lub nowoczesne, ciepłe i naturalne, purystyczne lub efektowne - pozwólcie się zainspirować!

Zapraszamy do przeglądania naszego nowego katalogu!



Digital an Ihrer Seite.

Das digitale Erfolgselement
für moderne Kommunikation –
unser B2B-Portal myTRIO

Digitally at your side.

The Digital Success Element
for Modern Communication –
our myTRIO B2B Portal



Vorteile für registrierte Geschäftspartnerinnen und Geschäftspartner

Profitieren Sie von unserem schnellen und unkomplizierten Support! Mit nur einem Klick haben Sie Zugriff auf alle wichtigen Artikeldaten und können bequem Dateien herunterladen. Entdecken Sie diese Vorteile in unserem digitalen B2B-Portal myTRIO. Registrierte Nutzer finden dort alle relevanten Informationen zu unseren Produkten, von technischen Details bis hin zu Bildmaterial und Lagerbeständen. Sind Sie noch nicht registriert? Zögern Sie nicht, uns zu kontaktieren.

Advantages for Registered Business Partners

Benefit from our fast and uncomplicated support! With just one click you have access to all important item data and can conveniently download files. Discover these advantages in our myTRIO digital B2B portal. Registered users will find all relevant information about our products there, from technical details to images and the amount of products in stock. You are not registered yet? Do not hesitate to contact us.

my.trio-lighting.com

Besuchen Sie uns auch bequem von Zuhause aus!

Tauchen Sie in die virtuelle Welt ein und erkunden Sie unseren Ausstellungsraum mit unserer interaktiven 360° Tour. Egal ob auf dem PC, Tablet oder Smartphone, der Rundgang steht Ihnen direkt im Webbrowser zur Verfügung. Besonders beeindruckend wird die Präsentation, wenn Sie eine VR-Brille verwenden. Weitere Informationen finden Sie auf unserer Webseite. Schauen Sie gerne vorbei und genießen Sie das Erlebnis. Viel Spaß!

You Can Also Visit Us From the Comfort of Your Own Home!

Dive into the virtual world and explore our showroom with our interactive 360° tour. Whether on a PC, tablet or smartphone, the tour is available directly in your web browser. The presentation turns particularly impressive if you use VR glasses. You can find more information on our website. Feel free to stop by and enjoy the experience. Enjoy!



Funktioniert auch mit VR-Brillen
Also works with VR glasses

trio-lighting.com/showroom

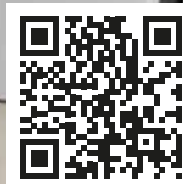

SERIENÜBERSICHT

Family overview · Aperçu par famille · Overzicht per familie · Vista general por familia ·
Panoramica per famiglia · Prezentare pe familii de produse · Perheen yleiskuvaus · Przegląd rodziny

AARON	48	BOLSA	518	CURTIS	430	GRANADA	270
ADRIAN	345	BOOLAN	213	DAKOTA	422	GRANBY	404
ADRIANO	351	BRAD	180	DAVI II	437	GRANT	225
AGRA	204	BRANTFORD	402	DEACON	175	GRIFFIN	54
AGUDO	144	BULLET	294	DELHI	200	GROOVY	274
AICK	224	BURTON	130	DIALLO	154	GUAYANA	455
AKITA	305	CAMDEN	118	DIAMO	57	HARPER	164
ALICIA	104	CAMILLA	538	DIEGO	260	HARRIS	206
ALINO	375	CAMILLUS	498	DISCALGO	98	HEDDA	184
AMSTERDAM	440	CAMPO	364	DIVO	364	HELIOS	217
ANGELO	536	CANDELA	240	DOHA	310	HOSTEL	136
ANTIBES	496	CARRERA	82	DOLOMITE	510	HOTEL	124
APART	540	CASSIO	382	DONNA	432	HYDRA	288
ARAGON	372	CAYA	266	DOWNEY	284	ICARO	427
ARGENTINA	397	CESAR	333	DURBAN	229	INDIRA	300
ARGUS	507	CHARIVARI	72	ECCO	371	INGA	186
ARINO	352	CHARLESTON	283	EDGE	78	IRVINE	278
ARIZONA	410	CHARLY	56	EDWARD	423	JASMIN	256
ARUNI	176	CHIRAZ	247	ELEMENT	359	JIMMY	500
ARVIN	303	CHIRON	246	ELISA	114	JIVE	85
ARY II	436	CHIROS	355	ELMAU	194	JOHANN	341
ASCARI	534	CHRIS	407	EMERALD	434	JOOST II	432
AURA	504	CINZIA	539	FABIO	524	JORDAN	357
AVA	441	CLAAS	388	FERNANDO	334	JUDITH	212
BALDO	362	CLAPTON	456	FILIGRAN	421	JULIETA	142
BALE	428	CLARIMO	547	FILO	250	JURA	514
BALINI	106	CLARK	380	FLETCHER	251	KAGAWA	304
BANGKOK	398	CLAYTON	236	FLEXO	446	KAZAN	418
BARCA	166	CLEO	354	FRANCIS	80	KENAI	512
BARON	92	COLINO	190	FRANKLIN	66	KERALA	172
BARRIE	406	CONCHA	347	FREDDY	426	KHAN	182
BELFAST	221	COOKIE	337	FRODENO	543	KIMI	444
BELL	198	CORD	257	FYNN II	439	KOLIAN	530
BELLARI	174	CORE	505	GALE	286	KORBA	192
BERGAMO	412	CORTEZ	248	GANADO	290	KULA	521
BERLIN	435	CRISTO	434	GARDA	138	LACAL	220
BISCUIT	339	CROSS	152	GIADA	551	LACAPO	349
BLAZE	74	CRYSTEL	293	GIANNI	535	LANA	344
BODRUM	297	CUADRO	360	GIRONA	314	LANCE	394
BOLDER	363	CURL	228	GONZALO	332	LEON	468

LEVISTO	472	MOTEL	387	RAMA	168	TAMIL	150
LIÈGE	393	NAGANO	329	RAMON	374	TAURUS	452
LIGARA	370	NALIDA	56	RAVEN	346	TEXEL	392
LILLY	366	NANDOR	390	RAY	520	THEATRO	533
LINE	362	NARCOS	458	RILA	511	THIAGO	50
LINO	548	NILAM	193	ROBIN	108	THOMPSON	46
LIVIA	249	NIMBUS	506	ROCCO	522	TILL II	436
LORELEY	245	NOLA	429	RODRIGO	205	TIRIAC	298
LORENA	105	NORIAKI	331	ROMA	367	TITUS	322
LORENZO	550	NURIA	70	ROMINO II	244	TOKYO	327
LOUIS	348	OAKLAND	81	RONDO	86	TOMMY	500
LUCERNA	243	ONTARIO	241	ROPE	212	TOSH	208
LUGANO	320	ONYX	254	ROSS	140	TRACY	381
LUGO	268	OSAKA	324	ROUBAIX	492	TRADITIO	160
LUIS II	438	OXFORD	299	ROXIE	147	TRAJAN	218
LUMINA	102	PAGO	471	RUNA	188	TRAY	88
LUNAR	330	PALI	342	RUSTICA	156	TUBULAR	226
LUPO	447	PAMIR	509	SABIA	384	TUCSON	281
LYON	122	PANEL	498	SALINAS	76	UMBERTO	541
MADISON	94	PAOLO	542	SAMURAI	328	VAPORE	100
MADRAS	210	PAPER	260	SANDRINA	116	VARIO	442
MANSUR	378	PARIS II	389	SANNA	253	VENTURA	433
MARIO	358	PAROS	495	SANTO II	411	VERONA	413
MARLEY	464	PAVIA	416	SEASONS	196	VERUS	323
MARNIE	60	PEACOCK	296	SEDONA	280	VIA	276
MARRIOT	356	PERRY	445	SEIKO	326	VIEW	532
MATS II	438	PHOENIX	319	SEQUENCE	62	VIOLA	261
MATTIMO	528	PIERA	526	SHANGHAI	399	VISTA	52
MEDERA	170	PIRIN	510	SHOGUN	328	WACO	309
MELA	238	PLANT	211	SIGNA	117	WALES	350
MELBY	53	PLATON	350	SOLA	396	WANDA	368
MERTON	222	POLO	446	SORRENTO	282	WINONA	291
MICHAEL	470	PRIMO	344	SPIRELLI	115	XAVI	544
MIGUEL	348	PRONTO	448	SPLIT	409	YAVA	285
MIKO	325	PURA	365	STAMINA	259	ZAGROS	508
MINSK	242	PURE	110	STANLEY	324	ZANDOR	90
MITA	306	QUEBEC	401	STEAM	476	ZAZOU	366
MONTILLA	273	QUINTA	340	SYDNEY	83	ZENIA	546
MONZA	414	RADIATOR	492	TAILOR	178	ZODIAC	265
MORGAN	312	RADO	443	TAJO	449	ZUCCA	252

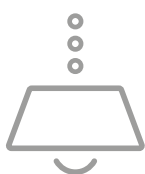

PENDELLEUCHTEN & KRONEN

Pendants & chandeliers · Lustres & suspensions · Hanglampen & kroonluchters ·
Colgantes y Lámparas · Lampadari e sospensioni · Lustre si pendule · Riippu- & kruunu ·
Wiszące i żyrandole



MARNIE 60



NURIA 71

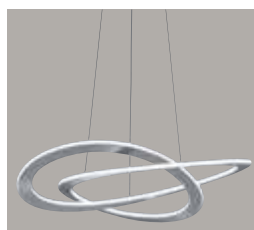

OAKLAND 81



FRANCIS 80

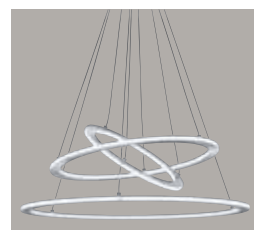

DURBAN 229



CARRERA 82



CURL 228



RONDO 86

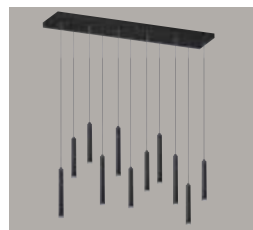

TUBULAR 226



TRAY 88



CHARIVARI 72



SALINAS 76

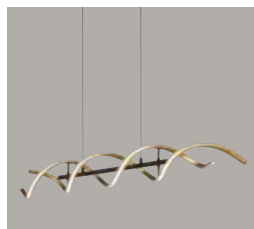

SEQUENCE 65

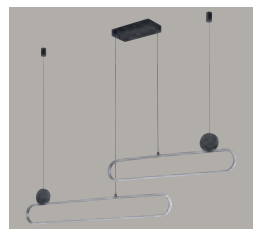

GRANT 225



EDGE 78



HELIOS 217

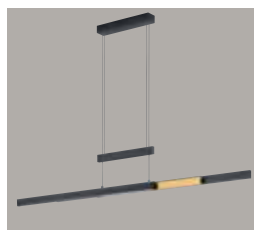

TRAJAN 218



LACAL 220

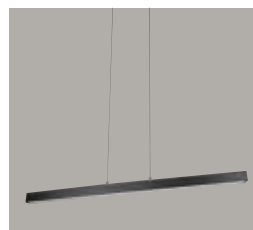

BELFAST 221

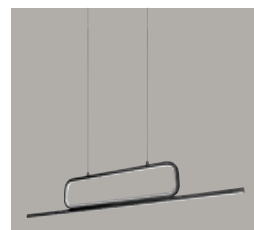

AICK 224

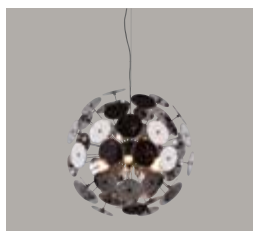

DISCALGO 98

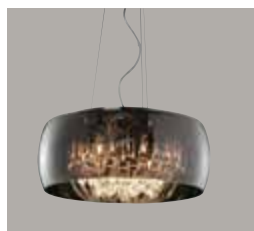

VAPORE 100



ALICIA 104



LORENA 105

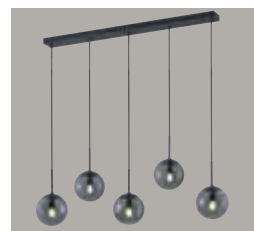

BALINI 106



STANLEY 324



MELA 238



CLAYTON 236



PURE 110



ROBIN 108



BARON 92



ZANDOR 90



FILO 250

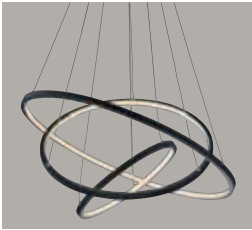

AARON 49



THOMPSON 47



FRANKLIN 66



MADISON 94



BLAZE 74



MARLEY 230



MERTON 222



LUMINA 102



FLETCHER 251



MARLEY 230



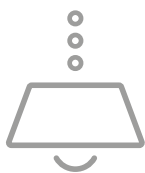

PENDELLEUCHTEN & KRONEN

Pendants & chandeliers · Lustres & suspensions · Hanglampen & kroonluchters ·
Colgantes y Lámparas · Lampadari e sospensioni · Lustre si pendule · Riippu- & kruunu ·
Wiszące i żyrandole



HARPER 164



DEACON 175



KERALA 173

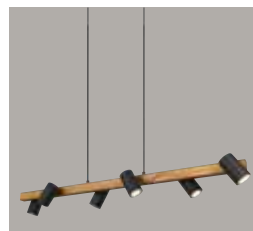

MARLEY 230



AGRA 204



TAMIL 150



TOSH 208



INGA 186



RUNA 188



COLINO 190



HARRIS 206

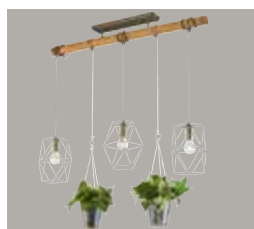

PLANT 211



ELMAU 194



ROSS 141



GARDA 139



CAMDEN 118



ONTARIO 241



CANDELA 240



LUCERNA 243



MINSK 242



LORELEY 245



HOSTEL 137



ROMINO II 244



CHIRAZ 247



ROXIE 147

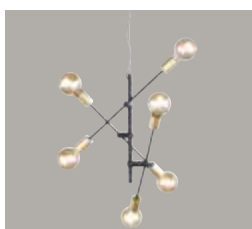

CROSS 152

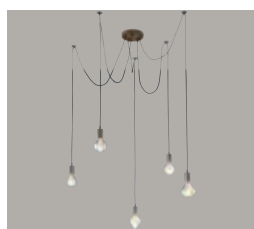

CORD 257



ONYX 254



RUSTICA 156



TRADITIO 160



SANDRINA 116



SIGNA 117



SPIRELLI 115



ELISA 114



STAMINA 259



BRAD 180

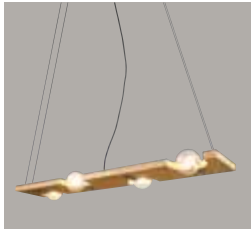

TAILOR 178



KHAN 183



BELL 199



DELHI 200



HEDDA 184



BOOLAN 213



ROPE 212



JUDITH 212



BURTON 130



JULIETA 142



ZUCCA 252



CORTEZ 248



LIVIA 249



CHIRON 246



AGUDO 144



SANNA 160



JASMIN 256



LEVISTO 258



VIOLA 261



DIEGO 260



PAPER 260



DECKENLEUCHTEN

Ceiling lamps · Plafonniers · Plafonnières · Plafones · Plafoniere · Plafoniere · Kattvalaisimet · Plafony



MARNIE 60



CAYA 266



ZODIAC 265



GRANADA 270



LUGO 268



NURIA 70



FRANCIS 80



OAKLAND 81



CARRERA 82

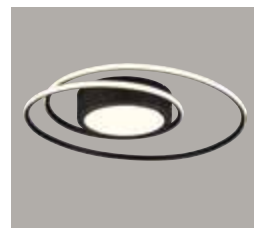

YAVA 285



MONTILLA 273



GALE 286



RONDO 86



GROOVY 274

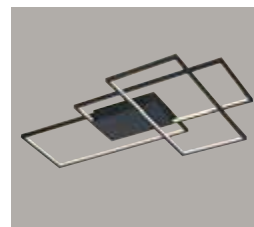

THIAGO 50



SEDONA 280

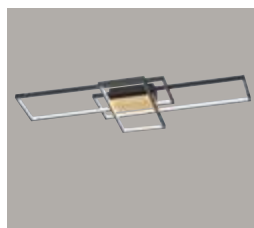

TUCSON 281

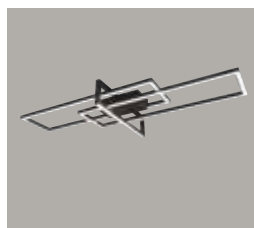

SALINAS 76



IRVINE 278

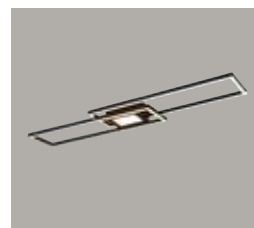

GANADO 290



CHARLESTON 283



SYDNEY 83



SEQUENCE 62



BLAZE 74



HARPER 164



MEDERA 170



BRAD 180

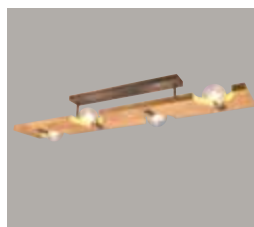

TAILOR 178

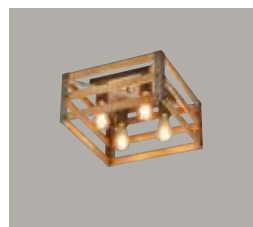

KHAN 182



TAMIL 150



COLINO 190



INGA 186



HEDDA 184



ELMAU 194



PALI 342



CHARIVARI 72

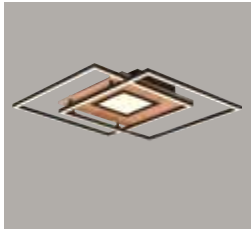

VIA 276

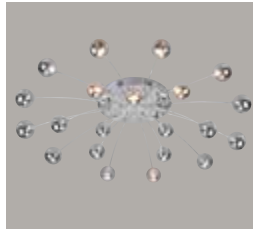

BULLET 294

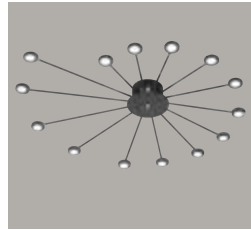

PEACOCK 296

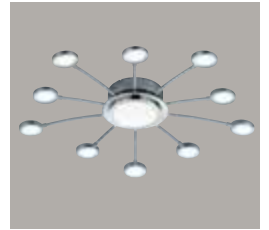

BODRUM 297



JIVE 85



AARON 48

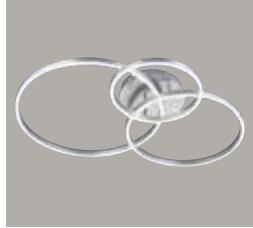

WINONA 291

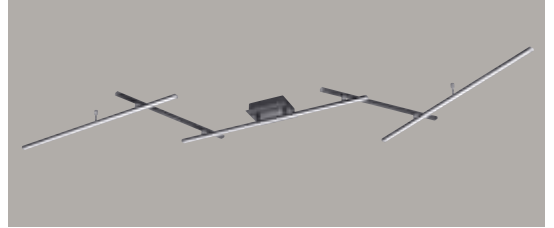

ARVIN 303

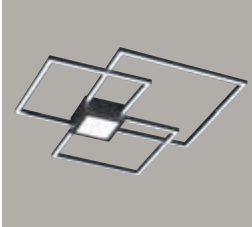

HYDRA 288



DOWNEY 284



THOMPSON 46

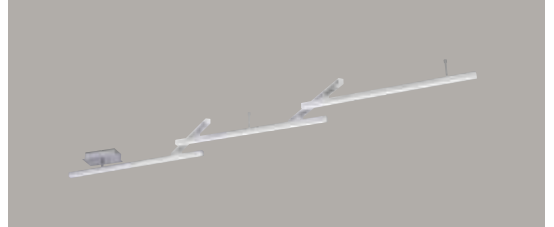

MELBY 53

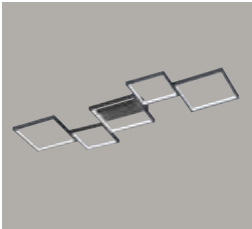

SORRENTO 282

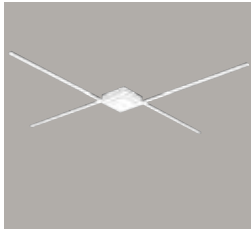

OXFORD 299

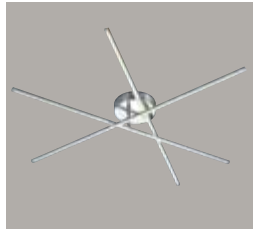

TIRIAC 298

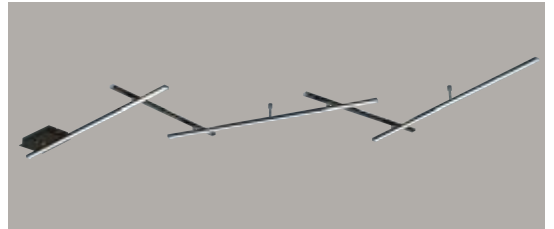

INDIRA 300



BARCA 166

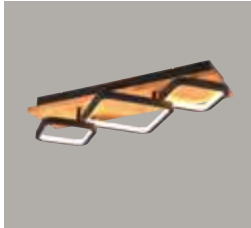

RAMA 168



KERALA 172

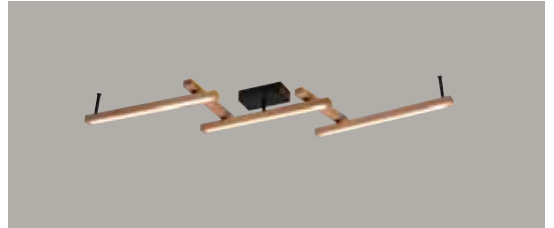

BELLARI 174

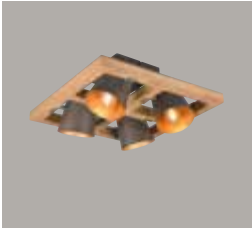

BELL 198



DEACON 175



SEASONS 196



DECKENLEUCHTEN

Ceiling lamps · Plafonniers · Plafonnières · Plafones · Plafoniere · Plafoniere · Kattvalaisimet · Plafony

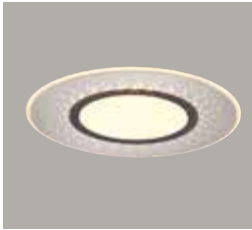

VERUS 323



MIKO 325



TOKYO 327



OSAKA 324



NORIAKI 331



NALIDA 56



CHARLY 56



GRIFFIN 54



TITUS 322



CESAR 333



WACO 309



DOHA 310



GIRONA 314



PHOENIX 316



TRAY 88



FRANKLIN 68



MORGAN 312



CHIROS 355



JULIETA 142



HOSTEL 136



DISCALGO 98

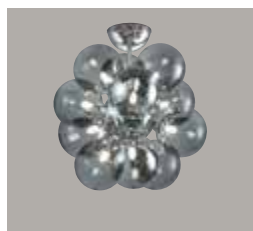

ALICIA 104

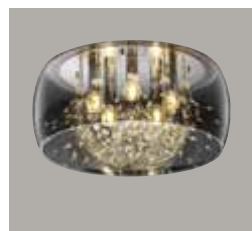

CRYSTEL 293



VAPORE 100



LORENA 105

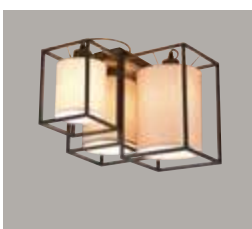

ROSS 140



AGUDO 144



QUINTA 340

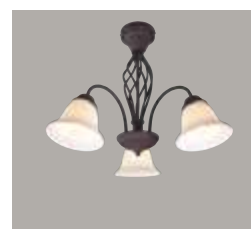

RUSTICA 156

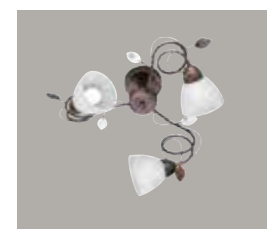

TRADITIO 160



ADRIAN 345



SANDRINA 116



LANA 344

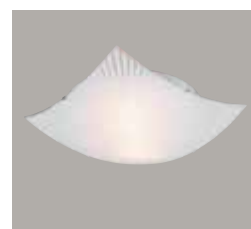

ELISA 114



SPIRELLI 115



NAGANO 329



LUNAR 330



SHOGUN 328



SEIKO 326

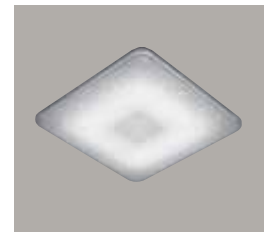

SAMURAI 328



GONZALO 332



KAGAWA 304

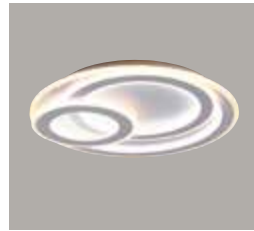

MITA 306

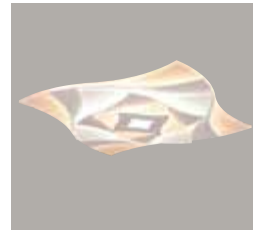

AKITA 305



ZANDOR 90



BARON 92



FERNANDO 334



BISCUIT 339



COOKIE 337



BURTON 132



HOTEL 126



LUGANO 320



CAMDEN 118



DIAMO 57



ROXIE 148

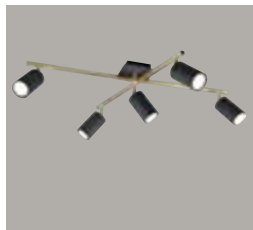

MARLEY 467

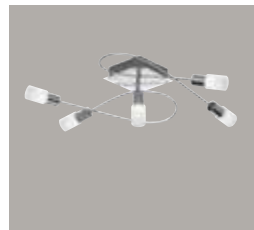

CLAPTON 457



GARDA 138

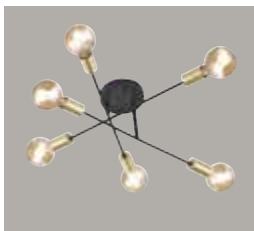

CROSS 152



JOHANN 341

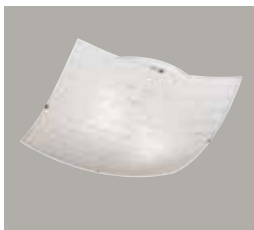

SIGNA 117



LILLY 366



WANDLEUCHTEN

Wall lamps · Appliques · Wandlampen · Apliques ·
Appliques · Lämpi de perete · Seinävalaisimet · Scienne



MIGUEL 348



LACAPO 349



LOUIS 348



CONCHA 347



RAVEN 346

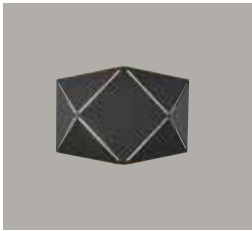

ZANDOR 90



MARIO 358



JORDAN 357



ELEMENT 359

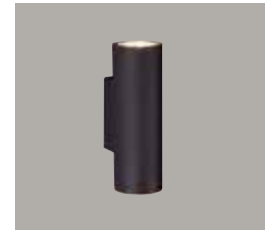

MARLEY 467



SEQUENCE 62



LUGO 268

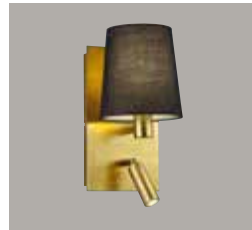

MARRIOT 356



CASSIO 382

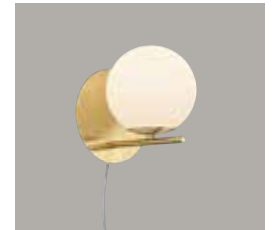

PURE 110



BARCA 166



KERALA 172



ARINO 352



BRAD 180

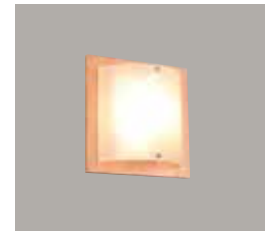

PALI 342



NILAM 193



LYON 122



HOTEL 124



EDWARD 423



KAZAN 418



BALDO 362



BOLDER 363



LINE 362



DIALLO 154



CAMPO 364



ELISA 114



SANDRINA 116



SPIRELLI 115



SIGNA 117



DIVO 364



ADRIANO 351



PLATON 350

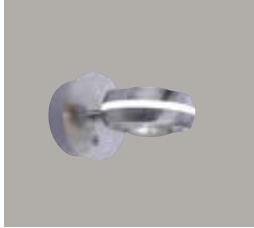

VISTA 52



WALES 350

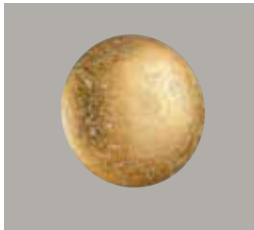

CHIOS 355



CLEO 354



KHAN 182



RUNA 188



CURTIS 430



CUADRO 360



TRADITIO 161



PURA 365



ROMA 367



ZAZOU 366



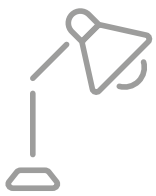

TISCHLEUCHTEN

Table lamps · Lampes de table · Tafellampen · Sobremesas ·
Lampa da tavolo · Veioze · Pöytävalaisimet · Lampy stołowe



CHARIVARI 73



FRANKLIN 68



MADISON 95



RONDO 87



SYDNEY 83



VAPORE 100



LORENA 105



ROBIN 108



KERALA 173



TAILOR 178



SABIA 384



CASSIO 382



PARIS II 389



LYON 122



NANDOR 390



NOLA 429



JOOST II 432



BERLIN 435



DONNA 432



PURE 110



FYNN II 439



CRISTO 434



ARY II 436



TILL II 436



DAVI II 437



AMSTERDAM 440



AVA 441



VARIO 442



RADO 443



MONZA 414



KIMI 444



TOSH 209



ROXIE 147



PERRY 445



POLO 446



EDGE 78



SEQUENCE 63



BLAZE 74



TEXEL 392



INGA 186



ELMAU 194



JULIETA 142



BALE 428



ROSS 141



HOTEL 128



HOSTEL 136



BURTON 130



MATS II 438



GARDA 138



VENTURA 433



LUIS II 438



EMERALD 434



DIALLO 154



RUSTICA 158



TRADITIO 161



BERGAMO 412



PAVIA 416



CURTIS 430



NARCOS 459



MARLEY 424



LUPO 447



PRONTO 448



TAJO 449



WANDA 368



FLEXO 446



STEHLEUCHTEN

Floor lamps · Lampadaires · Vloerlampen · Lámparas de pie ·
Piantane · Lampadare · Lattiavalaisimet · Lampy podłogowe



CAMDEN 118



LYON 123



SABIA 384



PARIS II 389



CASSIO 382



HOTEL 124



MOTEL 387



BURTON 134



CLAAS 388

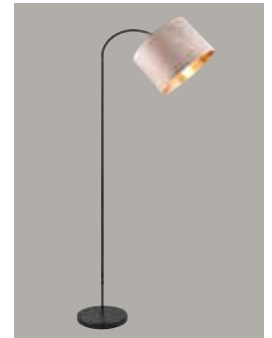

JULIETA 142



NANDOR 390

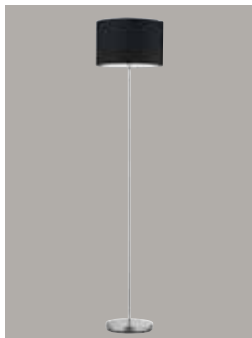

HOTEL 124



HOSTEL 136



ROSS 140

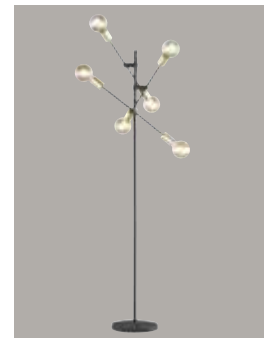

CROSS 152



KERALA 173



BELLARI 174

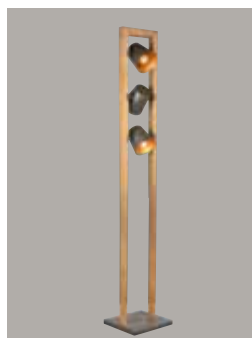

BELL 198

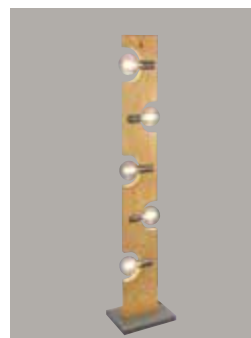

TAILOR 178



KHAN 183



HEDDA 184



RUNA 188



TOSH 209



HARRIS 206



RODRIGO 205



MANSUR 378



CLARK 380



TRACY 381

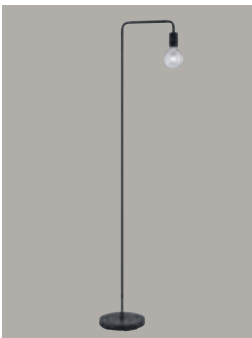

DIALLO 154

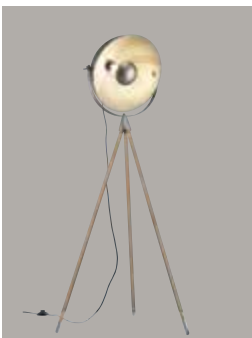

DELHI 202



KORBA 192

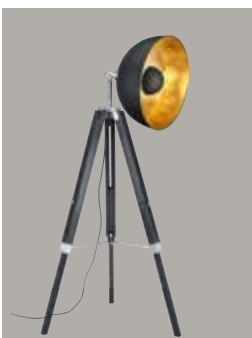

LIEGE 393





STEHLEUCHTEN

Floor lamps · Lampadaires · Vloerlampen · Lámparas de pie ·
Piantane · Lampadare · Lattiavalaisimet · Lampy podłogowe



FRANKLIN 66



QUEBEC 400



BRANTFORD 402



GRANDBY 404



BARRIE 406



CHRIS 408

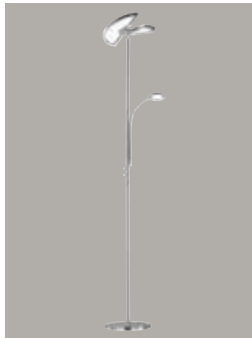

SPLIT 409

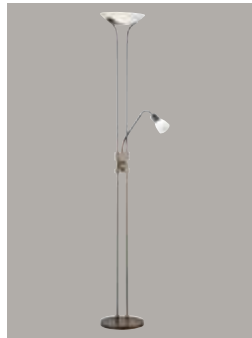

SANTO II 411

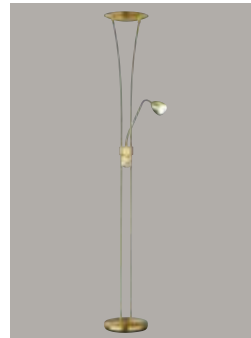

ARIZONA 410



RUSTICA 158

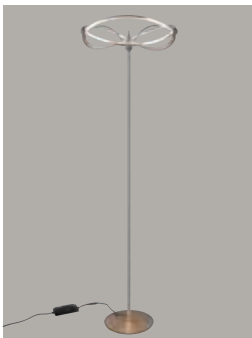

CHARIVARI 73



SEQUENCE 65



BLAZE 74



EDGE 78



TEXEL 392



FRANKLIN 66



VERONA 413

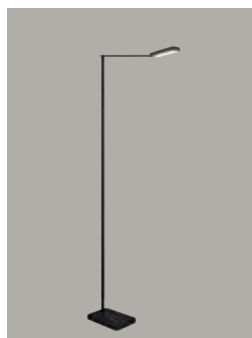

PAVIA 416

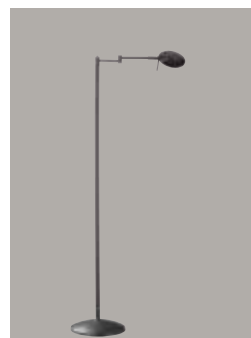

KAZAN 418

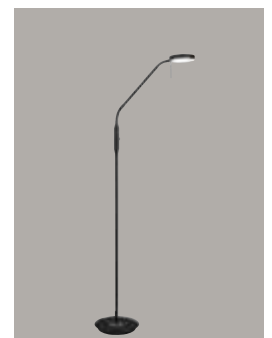

MONZA 414

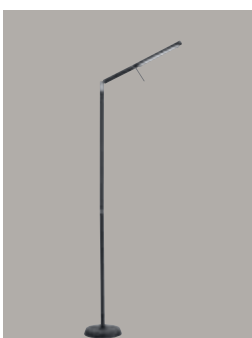

FILIGRAN 421

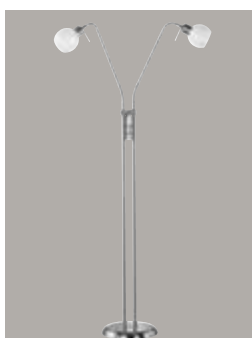

FREDDY 426



ICARO 427

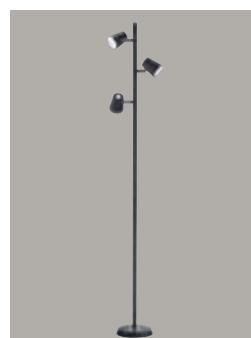

NARCOS 459

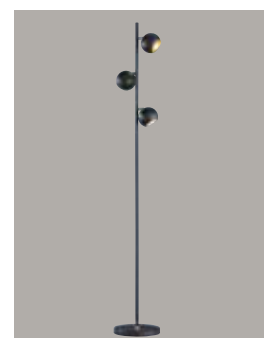

DACOTA 422

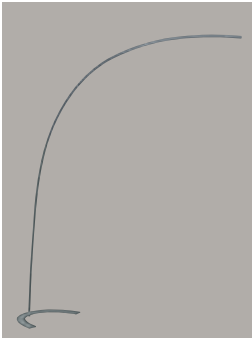

SHANGHAI 399



BANGKOK 398



SOLA 396

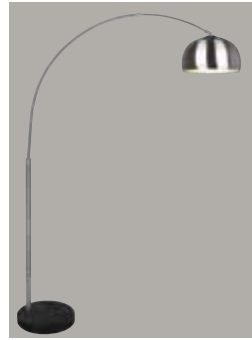

ARGENTINA 397



NURIA 71



JIVE 85

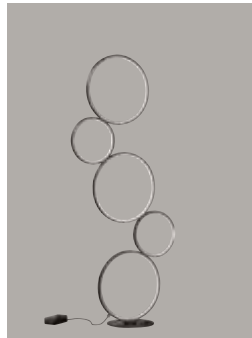

RONDO 87



SYDNEY 83



VAPORE 101



LUMINA 102

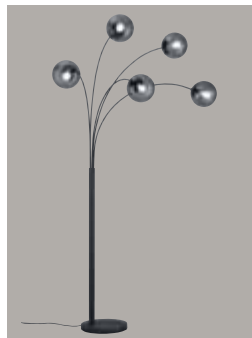

BALINI 106

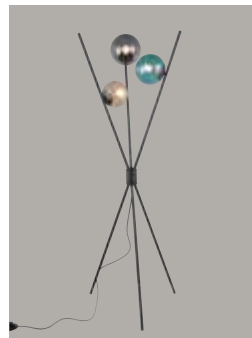

LANCE 394



BERGAMO 412



PURE 112



EDWARD 423

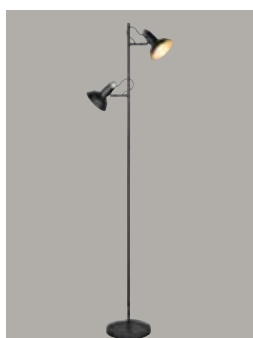

ROXIE 147

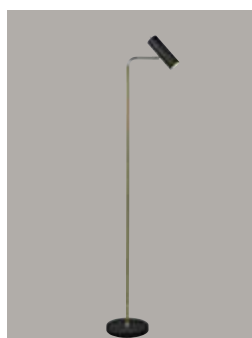

MARLEY 424

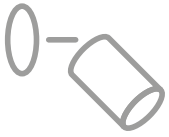

SPOTSERIEN

Spots · Spotterie · Spots · Focos · Faretti · Spoturi · Spotit · Reflektorki



CLAPTON 456



NARCOS 458



TAURUS 452



GUAYANA 455



PAGO 471



ANGELO 536



MARLEY 466



MICHAEL 470



LEVISTO 472



ARUNI 176



BELL 198



DELHI 202



TOSH 208



MADRAS 210



ROXIE 148



BURTON 132



STEAM 476



WANDA 368



LEVISTO 370



LIGARA 370



2-PHASEN-SCHIENENSYSTEM



2-phase track system · Système de voie à deux phases · 2-fase-spoorsysteem ·
Sistema de rieles en 2 fases · Sistema a binario bifase · Sistem de piste cu 2 faze ·
2-vaihekiskojärjestelmä · 2-fazowy system prowadnic



RADIATOR 492



LEON 492



MARLEY 494



ROUBAIX 492



ANTIBES 496



TOSH 497



DIALLO 497



TOMMY 500



CAMILLUS 498



PANEL 498



HOTEL 500



HOSTEL 501

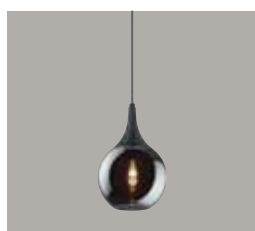

LUMINA 496



ROBIN 496



MARLEY 494



HOTEL 500



HOSTEL 501



JIMMY 500



ONTARIO 496



PAROS 495



EIN- UND UNTERBAULEUCHTEN

Recessed and cabinet lightings · Eclairages encastrés et éclairages sous armoire ·
Inbouwverlichtingen en verlichtingen onder de kastjes · Luces empotrables y luces para la parte inferior
del armario · Lampade da incasso e lampade sottopensili · Lumini încestate și lumini sub dulap ·
Upotettavat valaisimet ja kaapinalusvalaisimet · Oprawy wpuszczane oraz oprawy podszafkowe



ARGUS 507



NIMBUS 506



AURA 504



CORE 505



ZAGROS 508



ZAGROS 508

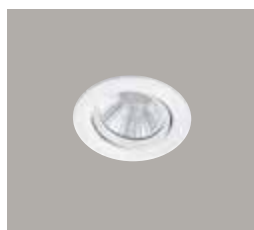

PAMIR 509

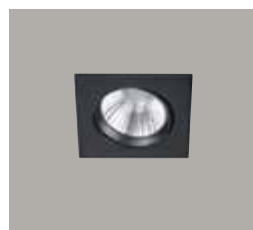

PAMIR 509



RILA 511



RILA 511



DOLOMITE 510



PIRIN 510

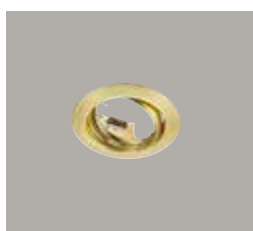

JURA 514



JURA 514



KENAI 512



ALINO 375



ARAGON 372



RAMON 374



ECCO 371



BADEZIMMERLEUCHTEN H₂O

Bathroom lighting · Éclairage salle de bains · Badkamer verlichting · Iluminación de cuarto de baño ·
Illuminazione per bagno · Iluminat baie · Kylpyhuone valaistus · Oświetlenie łazienkowe



BOLSA 518



ANGELO 536



ASCARI 534



CINZIA 539



UMBERTO 541



CONDUS 545



CAMILLA 538



CLARIMO 547



APART 540



PAOLO 542



FRODANO 543



GIANNI 535



THEATRO 533



VIEW 532



KULA 521



RAY 520



BOLSA 518



PIERA 526



KOLIAN 530



FABIO 524



XAVI 544



MATTIMO 528



LINO 548

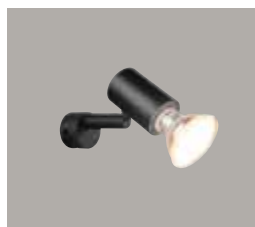

LORENZO 550



GIADA 551



ZENITA 546

TREND HIGHLIGHTS

2023/24

Coffee



DE

Es gibt doch nichts Schöneres, als sich bei der Gestaltung der eigenen vier Wände an den Farben der Natur zu orientieren. Die dezenten Creme- und Brauntöne sind vielseitig kombinierbar, verleihen Räumen eine einladende Wärme und erfüllen zugleich das Bedürfnis nach Ruhe und Behaglichkeit.

GB

There is nothing more beautiful than orientating yourself on the colours of nature when designing your home. The subtle shades of cream and brown can be combined in many ways, giving rooms an inviting warmth and at the same time fulfilling the need for peace and comfort.

FR

Il n'y a rien de plus beau que de vous inspirer des couleurs de la nature lors de la conception de votre maison. Les nuances subtiles de crème et de marron peuvent se marier de plusieurs façons, donnant aux pièces une chaleur accueillante tout en répondant au besoin de paix et de confort.



AGUDO
Seite / page 145

NL

Er is niets mooiers dan zich op de kleuren van de natuur te oriënteren bij het inrichten van je woning. De subtiele crème- en bruintinten kunnen veelzijdig gecombineerd worden, geven kamers een uitnodigende warmte en vervullen tegelijkertijd de behoefte aan rust en comfort.

ES

No existe nada más hermoso que inspirarse en los colores de la naturaleza a la hora de diseñar su hogar. Los tonos sutiles crema y marrón se pueden combinar de diversas maneras, lo que le aporta a los espacios una calidez acogedora y, al mismo tiempo, crea un hogar lleno de paz y comodidad.

IT

Quando si progetta la propria casa, non c'è cosa più bella che lasciarsi ispirare dai colori della natura. La delicatezza delle tonalità del panna e del marrone si presta a molteplici combinazioni, che conferiscono agli ambienti un calore avvolgente e che appagano al contempo l'esigenza di pace e di comfort.

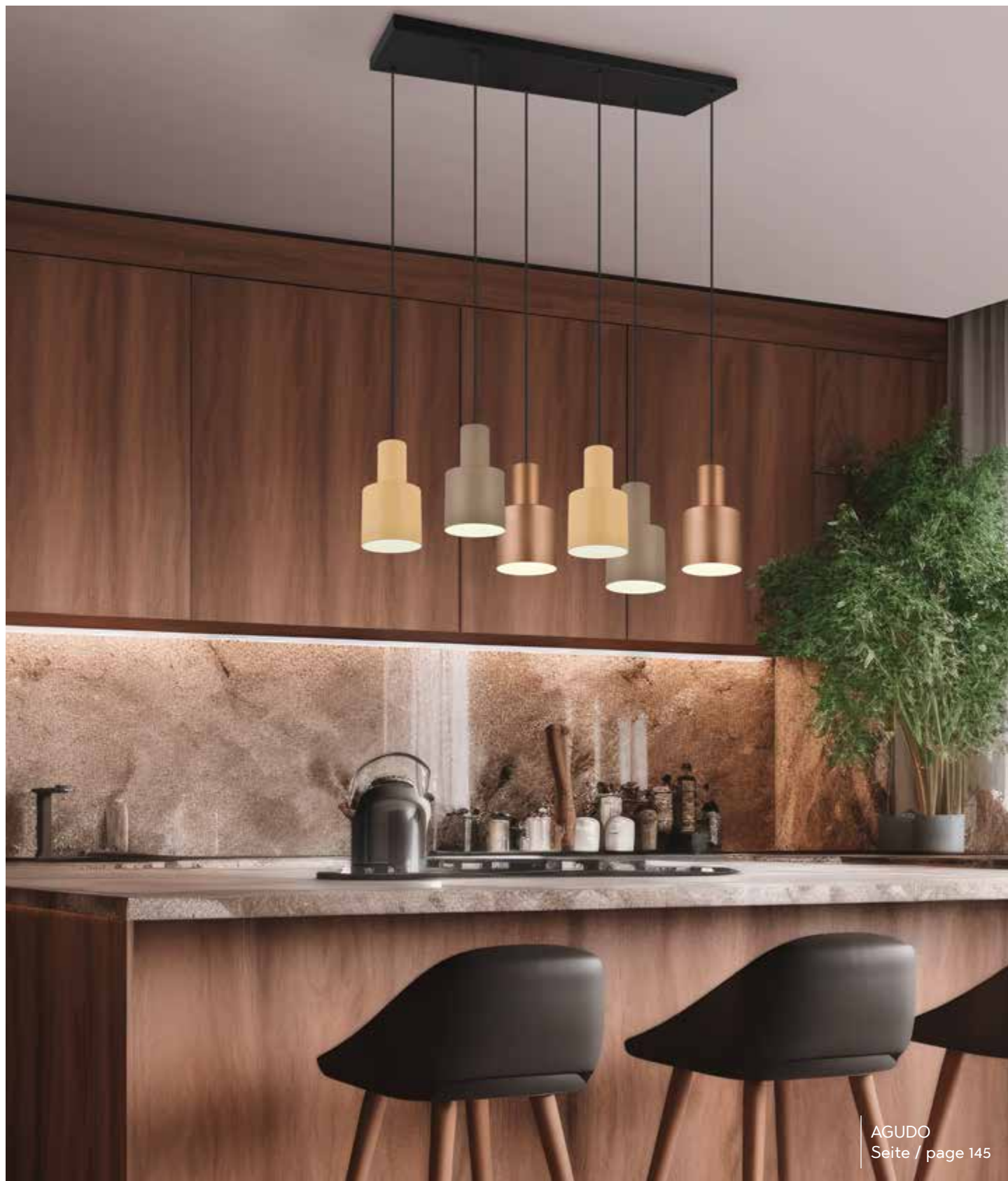

AGUDO
Seite / page 145

®

Nimic nu este mai plăcut decât să alegeți culorile naturii atunci când vă organizați căminul. Nuanțele subtile de crem și maro se pot combina în nenumărate moduri, oferind încăperilor o căldură primitoare și răspunzând, în același timp, nevoii de pace și confort.

®

Ei ole mitään kauniimpaa kuin luonnon värien huomioiminen kodin sisustuksessa. Herkkiä kerman ja ruskean sävyjä voidaan yhdistellä monella tavalla antaen huoneille lämpöä samalla täyttäen rauhallisuuden ja mukavuuden tarpeen.

®

Przy projektowaniu wnętrza swojego domu nie ma nic piękniejszego niż pójście w kierunku kolorów natury. Subtelne odcienie kremowe i brązowe można łączyć na wiele sposobów, nadając pomieszczeniom pociągające ciepło, zaspokajając jednocześnie potrzebę spokoju i komfortu.



BARCA
Seite / page 167

32

(NL) Als het gaat om het inrichten van woonruimtes, heerst er een duidelijke trend voor natuurlijke materialen. Dit gaat hand in hand met het toenemende bewustzijn van duurzaamheid. Hout is hierbij een belangrijk element. Vooral combinaties van licht hout met wittinten ogen aangenaam ingetogen en gezellig.

(RO) În designul interior există o tendință clară de folosire a materialele naturale. Această tendință merge mână în mână cu conștientizarea tot mai mare a sustenabilității. Lemnul reprezintă elementul central în această tendință. În special combinațiile de lemn deschis la culoare cu nuanțe de alb asigură un efect limitat și extrem de primitor.

(ES) Cuando se trata de diseño de interiores, hay una tendencia marcada hacia los materiales naturales. Esta tendencia va de la mano de la mayor concientización por la sustentabilidad, y la madera toma un papel protagónico. En especial, las combinaciones de madera clara con tonos blancos causan una sensación de sobriedad y comodidad que resulta placentera a la vista.

(FI) Sisätilojen suunnittelussa luonnolliset materiaalit muodostavat selvän trendin. Tietoisuus kestävästä kehityksestä lisääntyy, ja trendi kulkee sen kanssa käsi kädessä. Puu on tässä keskeinen elementti. Vaalean puun yhdistelmä valkoisilla sävyillä luo erityisen miellyttävän hillityn ja kodikkaan tunnelman.

(IT) Nel settore dell'arredamento d'interni, si registra una netta predilezione per i materiali naturali, una tendenza che si sposa con la crescente sensibilità al tema della sostenibilità. In un simile contesto, il legno è un elemento centrale. Gli accostamenti tra il legno chiaro e i toni del bianco, in particolare, conferiscono un effetto gradevole, raccolto e accogliente.

(PL) Jeśli chodzi o aranżację wnętrz, panuje wyraźny trend ukierunkowany na naturalne materiały. Trend ten idzie w parze z coraz większą świadomością w kwestii zrównoważonego rozwoju. Centralnym elementem jest tu drewno. W szczególności połączenie jasnego drewna z odcieniami bieli dają przyjemnie powściągliwy, a jednocześnie przytulny efekt.

Natur & Design

Nature & Design · Nature et design ·
Natuur en design · Naturalidad & Diseño ·
Natura e design · Natură și design ·
Luonto ja suunnittelu · Naturalność i dizajn



DE

Bei der Wohnraumgestaltung hält sich ein klarer Trend zu natürlichen Materialien. Dieser geht mit dem zunehmenden Bewusstsein für Nachhaltigkeit einher. Dabei bildet Holz ein zentrales Element. Vor allem Kombinationen aus hellem Holz mit Weißtönen wirken angenehm zurückhaltend und gemütlich.

GB

When it comes to interior design, there is a clear trend towards natural materials. This trend goes hand in hand with the increasing awareness of sustainability. Wood is a central element in this. Combinations of light wood with white tones in particular have a pleasantly restrained and cosy effect.

FR

Lorsqu'il s'agit de design intérieur, la tendance est nettement orientée vers des matériaux naturels. Cette tendance va de pair avec une sensibilisation accrue de la durabilité. Le bois y est un élément central. Des combinaisons de bois clair et de teintes blanches en particulier ont un effet agréablement discret et cosy.



ARUNI
Seite / page 177

Materialmix aus Stoff und Metall

Material mix of fabric and metal · Mélange de tissu et de métal ·
Materiaalmix van stof en metaal · Combinación de tejidos y metal ·
Combinazione di materiali: tessuto e metallo ·
Combi-nație de materiale textile și metal ·
Kankaan ja metallin sekoitus ·
Łączenie materiałów – tkanina i metal

34

Ⓓ Die mattschwarzen Metallgestelle sind von klaren Strukturen und Understatement geprägt. In Kombination mit naturfarbenen Textilschirmen strahlen die Leuchten Wärme und Gemütlichkeit aus – perfekt für all jene, die Schlichtheit suchen und es trotzdem romantisch mögen.

Ⓔ The matt black metal frames are characterised by clear structures and understatement. In combination with natural-coloured textile shades, the lights radiate warmth and cosiness – perfect for all those who are looking for simplicity and still like it romantic.

Ⓕ Les cadres métalliques noirs mats sont caractérisés par des structures claires et de la sobriété. En combinaison avec des nuances textiles aux couleurs naturelles, les lumières rayonnent de chaleur et de confort – parfaites pour toutes celles et ceux qui recherchent de la simplicité et aiment le romantisme.



Ⓖ De matzwarte metalen frames worden gekenmerkt door heldere structuren en understatement. In combinatie met naturelkleurige stoffen lampenkappen stralen de lampen warmte en gezelligheid uit – perfect voor wie op zoek is naar eenvoud en toch van romantiek houdt.

Ⓗ Los marcos de metal negro se caracterizan por sus estructuras definidas y su simpleza. En combinación con tonos textiles de color natural, las luces irradian calidez y comodidad. Por lo tanto, son perfectas para aquellos que buscan la simpleza y, aun así, disfrutan de un toque romántico en el ambiente.

Ⓙ Le strutture in metallo nero opaco sono caratterizzate da linee chiare e sobrie. Abbinare alle tonalità naturali dei tessuti, le lampade irradiano calore e intimità: la soluzione perfetta per chi cerca la semplicità e ama il romanticismo.



ROSS
Seite / page 141

RO

Cadrelle mate negre din metal se caracterizează printr-o structură clară și lipsă de emfază. În combinație cu abajururi din materiale textile în culori naturale, lămpile radiază căldură și o atmosferă plăcută - ideală pentru toți cei care își doresc simplitate și încă apreciază romantismul.

FI

Matan mustilla rungoilla on vaaleat rakenteet ja perustat. Yhdessä luonnonväristen tekstiilisävyjen vaaleiden sävyjen kanssa ne sädehtivät lämpöä ja kodikkuutta – täydellinen niille, jotka etsivät yksinkertaisuutta romantiikasta luopumatta.

PL

Czarne matowe metalowe oprawy charakteryzują się przejrzystą strukturą i pewnym niedopowiedzeniem. Światła w połączeniu z tekstylnymi abażurami w naturalnym kolorze emanują ciepłem i przytulnością – jest to idealne rozwiązanie dla wszystkich osób, które szukają prostoty, a przy tym lubią mają romantyczna duszę.

Design & Funktionalität

Design & functionality · Design et fonctionnalité · Design en functionaliteit · Diseño & Funcionalidad · Design e funzionalità · Design și funcționalitate · Suunnittelu ja toimivuus · Model i funkcjonalność

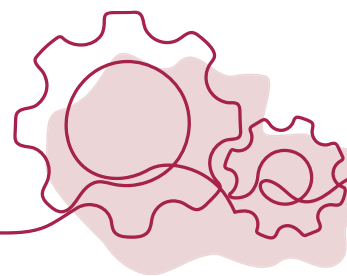

36

Ⓓ Tischbeleuchtung sollte stimmungsvoll, aber auch situativ anpassbar sein. Die Pendelleuchte Helios zeichnet sich durch außergewöhnliches Design und exzellente Lichteigenschaften aus. Auf Knopfdruck sorgt sie nicht nur für das nötige Maß an Helligkeit, sondern bietet zugleich eine horizontale Verstellmöglichkeit, wodurch sich jegliche Tischsituationen spielend leicht meistern lassen.

ⒼⒷ While table lighting should be atmospheric, it should also be adaptable to the situation. The Helios pendant luminaire is characterised by exceptional design and excellent lighting properties. At just the touch of a button, not only does it provide the necessary level of brightness, but it also offers a horizontal adjustment option, making it easy to master any table situation.

ⒻⓇ Bien que l'éclairage de table doive être atmosphérique, il doit également s'adapter à la situation. Le luminaire suspendu Helios se distingue par un design exceptionnel et d'excellentes propriétés d'éclairage. En appuyant simplement sur un bouton, il apporte non seulement le degré nécessaire de luminosité, mais offre également une option de réglage horizontal, permettant de maîtriser toute atmosphère de table.





(NL)

Tafelverlichting moet sfeervol zijn, maar ook aanpasbaar aan de situatie. De hanglamp Helios kenmerkt zich door haar buitengewone design en uitstekende lichteigenschappen. Met een druk op de knop zorgt ze niet alleen voor de nodige helderheid, maar biedt tegelijk een horizontale verstelmogelijkheid, waardoor elke tafelsituatie met gemak kan worden beheerst.

(ES)

Si bien la iluminación de mesa debe ser ambiental, es importante que se pueda adaptar a la situación. La uminaria colgante Helios se caracteriza por tener un diseño excepcional y propiedades lumínicas excelentes. Cuando pulsa el botón, no solo obtiene el nivel de luz necesario, sino que también ofrece una opción de ajuste horizontal, que facilita el manejo de la iluminación en la mesa.

(IT)

Se è vero che l'illuminazione della tavola deve creare atmosfera, è altrettanto vero che deve sapersi adeguare alle circostanze. La lampada a sospensione Helios è caratterizzata da un design straordinario e da eccellenti proprietà di illuminazione. Con la semplice pressione di un pulsante, oltre a garantire la luminosità necessaria, consente di regolare la luce in senso orizzontale e di gestire agevolmente le varie circostanze di utilizzo del tavolo.

(RO)

Deși iluminatul mesei trebuie să creeze o anumită atmosferă, el trebuie să fie și ușor adaptabil diferitelor situații. Lustra Helios se caracterizează printr-un design excepțional și proprietăți excelente de iluminat. Prin simpla atingere a unui buton nu oferă doar nivelul necesar de luminozitate, ci și o opțiune de reglare pe orizontală, făcând-o potrivită pentru toate situațiile.

(FI)

Pöytävalaistuksesta halutaan tunnelmallinen, mutta samalla sen tulisi mukautua tilanteeseen. Helios-riippuvalaisin on malliltaan erilainen erinomaisilla valaistusominaisuuksillaan. Painikkeen painalluksella ei saada vain tarvittavaa valaistusta, se tarjoaa myös vaakasuoran säätövaihtoehtoa, jota on helppo vaihdella pöydän ääressä.

(PL)

Choć oświetlenie stołu powinno być nastrojowe, musi być również dostosowane do sytuacji. Oprawa wiszącej lampy Helios charakteryzuje się wyjątkowym wzornictwem i doskonałymi właściwościami oświetleniowymi. Naciśnięcie jednego przycisku zapewnia nie tylko wymagany poziom jasności, ale także opcję regulacji poziomej, co ułatwia dostosowanie do każdej sytuacji na stole.



DOHA
Seite / page 311

(NL)

Minimalisme is een van de hipste wootrends, het is tijdloos en ingetogen. Een inrichtingsstijl gebaseerd op helderheid en functionaliteit. Eenvoudige vormen en subtiele kleuren garanderen een sfeer en puristische elegantie zonder franjes.

(RO)

Minimalismul este una dintre cele mai în vogă tendințe în stilul de viață – este atemporal și sobru. Un stil de design interior bazat pe claritate și funcționalitate. Formele simple și culorile discrete garantează un mediu lipsit de ornamente inutile și o eleganță severă.

(ES)

El minimalismo es una de las tendencias de moda en el mundo de las viviendas. Es atemporal y sobrio, un estilo de diseño de interiores basado en la claridad y funcionalidad. Las formas simples y los colores discretos garantizan un ambiente sencillo y una elegancia refinada.

(FI)

Minimalistisuus on yksi kuumimmista trendeistä — se on ajatonta ja hillittyä. Sisätilojen suunnittelutyylillä perustuu kirkkauteen ja toimivuuteen. Yksinkertaiset muodot ja hillityt värit takaavat selkeälinjaisen tunnelman ja puhtaan eleganssin.

(IT)

Il minimalismo è una delle tendenze più in voga nel settore dell'arredamento: intramontabile e sobrio. Uno stile di interior design improntato alla chiarezza e alla funzionalità. Forme sobrie e colori discreti garantiscono un ambiente senza eccessi e un'eleganza purista.

(PL)

Minimalizm to jeden z najgorętszych trendów w życiu – jest skromny i ponadczasowy. Styl aranżacji wnętrz opiera się na przejrzystości i funkcjonalności. Proste kształty i dyskretne kolory gwarantują przyjemną atmosferę i bezpretensjonalną elegancję.

Zeitlose Eleganz

Timeless Elegance · Élégnance intemporelle ·
Tijdloze elegantie · Elegancia atemporal ·
Eleganza senza tempo · Eleganță atemporală ·
Ajatonta tyylikäyettä · Ponadczasowa elegancja

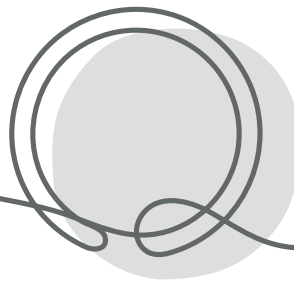

Ⓓ

Minimalismus zählt zu den angesagten Wohntrends, ist zeitlos und zurückhaltend. Ein Einrichtungsstil, der auf Klarheit und Funktionalität beruht. Schlichte Formen und dezente Farben garantieren ein schnörkelloses Ambiente und puristische Eleganz.

ⒼⒷ

Minimalism is one of the hottest trends in living – it is timeless and restrained. An interior design style based on clarity and functionality. Simple shapes and discreet colours guarantee a no-frills ambience and purist elegance.

ⒻⓇ

Le minimalisme est une des tendances les plus en vogue dans les logements - il est intemporel et discret. Un style de design intérieur basé sur la clarté et la fonctionnalité. Des formes simples et des couleurs discrètes garantissent une ambiance sans superflu et une pure élégance.

39



NOLA
Seite / page 429

Ein Klassiker in neuem Gewand

A classic in a new guise · Un classique dans une nouvelle forme ·
Een klassieker in een nieuw jasje · Un clásico reversionado ·
Un classico che si veste di nuovo · Un element clasic cu o nouă înfățișare ·
Klassinen uusi ominaisuus · Kłasyka w nowej odsłonie



(D) Zeitlos, geradlinig, schlicht und elegant. Sanfte, frische Farbtöne wie Pistaziengrün und leuchtendes Gelb vermitteln ein sonniges Gefühl und entsprechen dem Wunsch nach Wohnlichkeit und Entspannung. Die zusätzliche Beleuchtung im Fuß wertet die Lichtstimmung zusätzlich auf und sorgt für das gewisse Etwas.

(GB) Timeless, straightforward, simple and elegant. Soft, fresh shades such as pistachio green and bright yellow convey a sunny feeling and correspond to the desire for cosiness and relaxation. The additional lighting in the base additionally enhances the lighting mood and provides that certain something.

(FR) Intemporelles, directes, simples et élégantes. Des nuances fraîches et douces comme le vert pistache et le jaune clair transmettent une sensation ensoleillée et correspondent au désir d'intimité et de relaxation. L'éclairage supplémentaire dans le socle améliore en outre l'ambiance lumineuse et apporte ce petit plus.

(NL) Tijdloos, rechtlijnig, strak en elegant. Zachte, frisse kleuren zoals pistachegroen en knalgeel zorgen voor een zonnig gevoel en komen overeen met het verlangen naar comfort en ontspanning. De extra verlichting in de sokkel versterkt de lichtsfier en zorgt precies voor die extra toets.

(ES) Atemporal, claro, simple y elegante. Los tonos frescos y suaves, como el verde pistacho y el amarillo brillante aportan una sensación de luminosidad y hacen realidad el deseo de comodidad y relajación. Además, la iluminación adicional de la base realza el ambiente luminoso y aporta ese toque especial.

(IT) Intramontabile, lineare, semplice ed elegante. Nuance morbide e fresche come il verde pistacchio e il giallo intenso infondono un'atmosfera solare e conciliano l'esigenza di intimità e relax. Il sistema di illuminazione supplementare alla base esalta ancor di più l'atmosfera luminosa e conferisce un tocco di originalità.





®

Atemporal, direct, simplu și elegant. Nuanțele blânde și proaspete, cum ar fi verdele fistic și galbenul strălucitor, redau un sentiment înșorit și corespund dorinței de confort și relaxare. Lumina suplimentară din bază sporește și mai mult sentimentul de luminozitate și oferă o nuanță de inefabil.

®

Ajatonta, pelkistettyä, yksinkertaista ja tyylikästä. Pehmeät, raikkaat sävyt, kuten pistaasin vihreä ja kirkas keltainen tuovat mukanaan aurinkoisuutta ja lisäävät kodikkuutta ja rentouttavaa tunnelmaa. Lisävalaistus perusvalaistuksen lisäksi parantaa tunnelmaa ja tarjoaa jotain erikoista.

®

Ponadczasowość, bezpretensjonalność, prostota i elegancja. Miękkie, świeże odcienie pistacjowej zieleni czy jasnej żółci zapewniają poczucie nasłonecznienia i zaspokajają pragnienie przytulności i odprężenia. Dodatkowe oświetlenie przy podstawie jeszcze bardziej potęguje nastrój wywołany światłem i tworzy to coś.



THOMPSON
Seite / page 46

(NL)

Slimme thuisverlichting wordt meer en meer populair. Intelligente verlichtingsregeling biedt niet enkel maximaal gemak en maximale flexibiliteit, het opent ook volledig nieuwe mogelijkheden voor een creatief verlichtingsdesign. Op deze manier kunnen levenskwaliteit, leefcomfort en veiligheid tot een nieuw niveau gebracht worden.

(ES)

La iluminación de casas inteligentes se está volviendo cada vez más popular. El control inteligente de la iluminación no sólo ofrece la máxima comodidad y flexibilidad, sino que también da lugar a posibilidades completamente nuevas para el diseño creativo de la iluminación. De esta manera, la calidad de vida, comodidad y seguridad para vivir pueden alcanzar un nuevo nivel.

(IT)

L'illuminazione domestica smart sta diventando sempre più popolare. Il controllo intelligente dell'illuminazione non solo offre la massima comodità e flessibilità, ma apre anche nuove possibilità di progettazione creativa. In questo modo, la qualità della vita, il comfort abitativo e la sicurezza possono essere portati a un nuovo livello.

(RO)

Iluminatul inteligent al locuințelor devine din ce în ce mai popular. Controlul iluminatului inteligent nu numai că oferă maximul de ușurință și flexibilitate, dar de asemenea deschide noi posibilități pentru designul creativ al iluminatului. În acest fel, calitatea vieții, confortul de trai și siguranța pot fi ridicate la un nou nivel.

(FI)

Kotien älyvalaistuksesta on tulossa yhä suositumpaa. Älykäs valonsäätely tarjoaa maksimaalista käytännöllisyyttä ja joustavuutta, sekä avaa täysin uusia mahdollisuuksia luovalle valaistussuunnittelulle. Tällä tavoin elämänlaatu, asuinmukavuus ja turvallisuus voidaan viedä uudelle tasolle.

(PL)

Inteligentne oświetlenie w domu staje się coraz bardziej popularne. Inteligentne sterowanie oświetleniem oferuje nie tylko maksymalną wygodę i elastyczność, ale także otwiera zupełnie nowe możliwości kreatywnego projektowania oświetlenia. W ten sposób jakość życia, komfort i bezpieczeństwo można przenieść na wyższy poziom.

Smartes Licht

Smart lighting

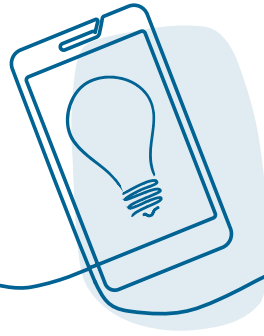

^(D) Smart Home-Beleuchtung erfreut sich zunehmend, steigender Beliebtheit. Intelligente Lichtsteuerung bietet nicht nur ein Höchstmaß an Komfort und Flexibilität, sie eröffnet auch völlig neue Möglichkeiten der kreativen Lichtgestaltung. Auf diese Weise lassen sich Lebensqualität, Wohnkomfort und Sicherheit auf ein neues Level bringen.

^(GB) Smart home lighting is becoming increasingly popular. Intelligent lighting control not only offers maximum convenience and flexibility, it also opens up completely new possibilities for creative lighting design. In this way, quality of life, living comfort and safety can be brought to a new level.

^(FR) L'éclairage intelligent des maisons devient de plus en plus à la mode. Le contrôle de l'éclairage intelligent offre non seulement un grand confort et une flexibilité maximale, mais ouvre également de nouvelles possibilités pour une conception d'éclairage créatif. De cette façon, la qualité de vie, le confort de vie et la sécurité peuvent être hissés à un tout autre niveau.



Get your light connected.



64.000 **WEISSTÖNE**
64,000 **WHITES**



Einstellbare Lichtprogramme · Preset light modes



16 Millionen **FARBEN**
16 million **COLORS**



Dynamische Lichtprogramme · Dynamic light modes



trio-lighting.com/wiz



Mehrere Standorte

Kontrollieren und Steuern von mehreren Standorten gleichzeitig und von überall aus. Ob das eigene Zuhause oder die Ferienwohnung.

Multiple locations

Control and command multiple locations simultaneously and from anywhere. Whether your own home or your holiday home.

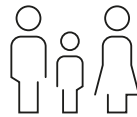

Mehrere Nutzer

Die Anzahl der Nutzer zur Steuerung der Leuchten kann individuell festgelegt werden.

Multiple user

The number of persons to control the lights can be set individually.



Cloud basiert

WiZ verbindet sich mit der Cloud, damit Vorlieben gespeichert, Wünsche geteilt und Updates automatisch generiert werden.

Cloud based

WiZ connects to the cloud to store preferences, share desires and generate updates automatically.



Keine zusätzliche Bridge erforderlich

Es wird keine zusätzliche Bridge oder Hub für die Steuerung der Leuchten benötigt.

No additional hub needed

There is no need for an additional bridge or hub to control the lights.



Mehrere Räume

Alle Leuchten können unterschiedlichen Räumen zugeordnet und präzise gesteuert werden – einzeln oder in Gruppen.

Several rooms

All lights can be assigned to different rooms and precisely controlled – individually or in groups.



Wlan Technologie

WiZ nutzt Wlan-Technologie als sichere, unabhängige, kostengünstige und einfach zu installierende Funklösung.

WiFi technology

WiZ uses Wi-Fi technology as a secure, independent, affordable and easy-to-install wireless solution.

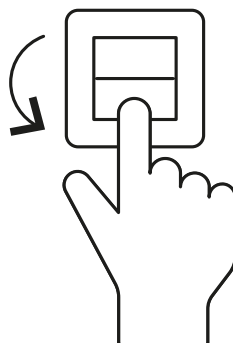

WiZ

CLICK

Einfach und effektiv. Zwei bevorzugte Lichtmodi können über den vorhandenen Lichtschalter bedient werden.

Simple and effective. Two preferred light modes can be operated via the existing light switch.



WiZ APP

Einfach und schnell installiert.
Volle Funktionalität und Flexibilität mit der WiZ App – erhältlich im App Store oder bei Google Play.

Easy and quick to install. Full functionality and flexibility with the WiZ App – available on the App Store or on Google Play.



WiZ MOTE

Steuerung über die Fernbedienung und Abspeichern von vier favorisierten Lichtmodi möglich.

Control via the remote control and possibility to save four favorite light modes.

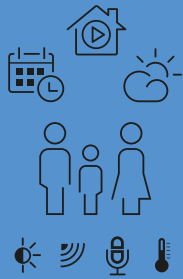

WiZ MAGIC

Steuerung der Leuchten über Zeitpläne, Sensoren oder einfache Sprachbefehle.
Kompatibel mit Amazon Alexa und Google Home.

Control of the lights by time schedules, with sensors or by simple verbal commands.
Compatible with Amazon Alexa and Google Home.

DIMMEN DIMMING



64.000 **WEISSTÖNE**
64,000 **WHITES**

Einstellbare Lichtprogramme · Preset light modes



16 Millionen **FARBEN**
16 million **COLORS**

Dynamische Lichtprogramme · Dynamic light modes



30 Sekunden zur Installation · **30** seconds to install



Die Lampe installieren
Install a lamp



Wählen Sie den „Koppeln“ Modus
Start pairing



3 x EIN / AUS
3 x ON/OFF



Die Lampe beginnt „blau“ zu blinken und schaltet danach auf weiß
Light turns blue then goes white



Die Einstellungen sind nun gespeichert, jeder kann zu Hause WiZ nutzen.

The settings are now saved!
Now everyone can use WiZ at your home.



THOMPSON

Metall, Aluminium gebürstet, Schwarz matt · metal, brushed aluminium, black mat ·
 métal, aluminium balayé, noir mat · metaal, geborsteld aluminium, mat zwart · metal, aluminio pulido, estera negra ·
 metallo, alluminio spazzolato, nero opaco · metal, aluminiu lucios, negru mat ·
 metalli, harjattu alumiini, mattamusta · metal, aluminium szczotkowane, czarny mat

SMART LIGHTING



RGB Farbwechsler ·
RGB Colorchanging



Lichtfarbe stufenlos einstellbar ·
Light color infinitely variable



Memory Funktion ·
Memory function



Deckenleuchte · Ceiling lamp
 Ø 52 cm, ↓ 12 cm
 incl. SMD-LED, 55 W
 5.500 lm, 2.700 - 6.000 K



653810305



Pendelleuchte · Pendant
 Ø 52 cm, ↓ 150 cm
 incl. SMD-LED, 55 W
 5.500 lm, 2.700 - 6.000 K



353810305



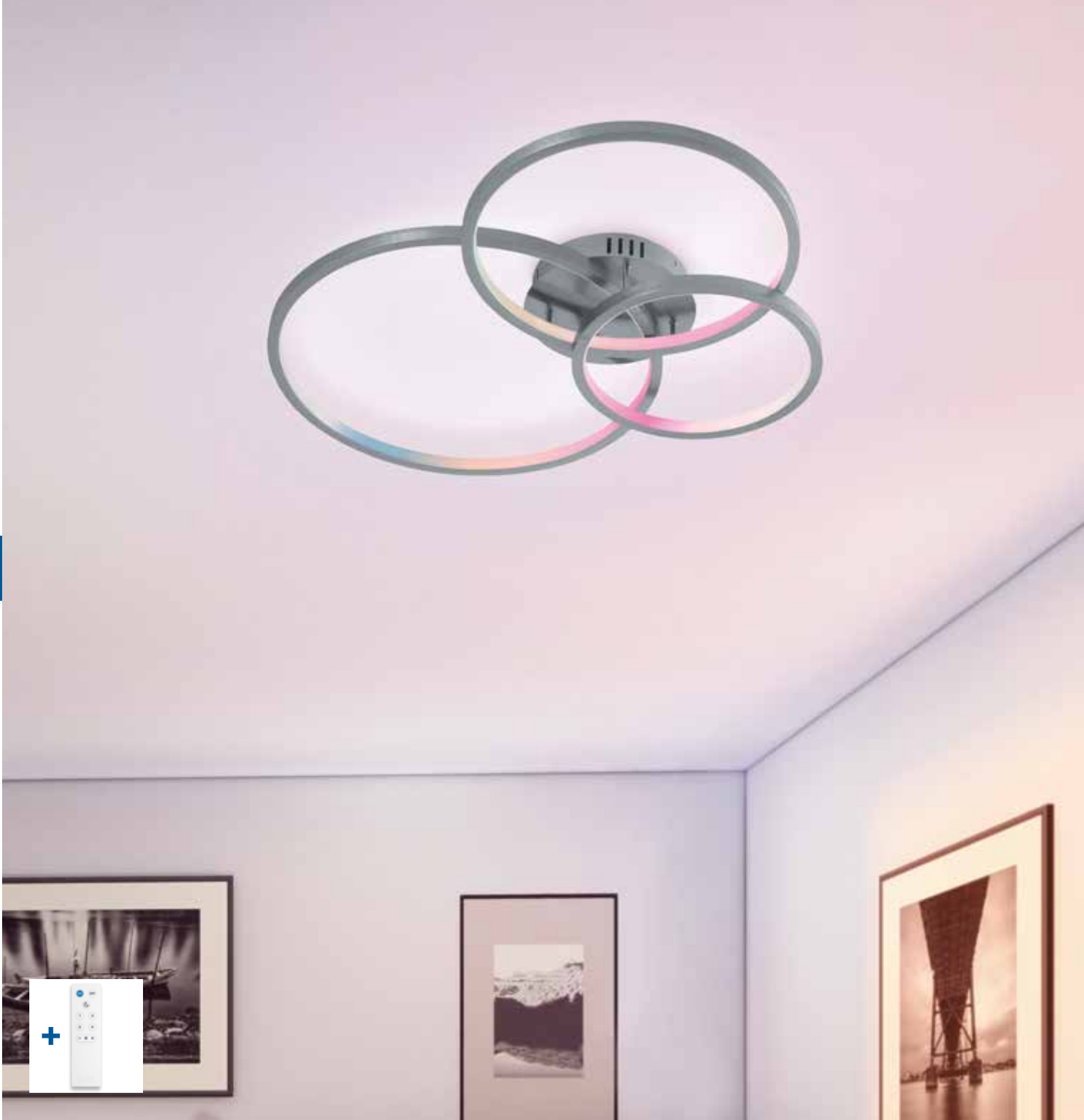

Deckenleuchte · Ceiling lamp

↔ 79 x 64 cm, ↑ 10,5 cm
incl. RGBW-LED, 36,5 W
4.200 lm, 3.000 - 6.000 K



652710307 | Nickel matt · nickel mat

652710342 | Anthrazit · anthracite





AARON

Metall, Nickel matt oder Anthrazit · metal, nickel mat or anthracite ·
 metale, nickel mat ou antracite · metaal, nikkel mat of antraciet ·
 metal, níquel mate o antracita · metallo, nichel opaco o antracite ·
 metal, nichel mat sau antracit · metalli, harjattu teräs tai antrasiitti ·
 metal, nikiel mat lub antracyt

SMART LIGHTING



RGBW Farbwechsler ·
 RGBW Colorchanging



Lichtfarbe stufenlos einstellbar ·
 Light color infinitely variable



Pendelleuchte · Pendant

Ø 80 cm, ↓ 150 cm
 incl. RGBW-LED, 78 W
 9.200 lm, 3.000 - 6.000 K



352710307 | Nickel matt · nickel mat
 352710342 | Anthrazit · anthracite

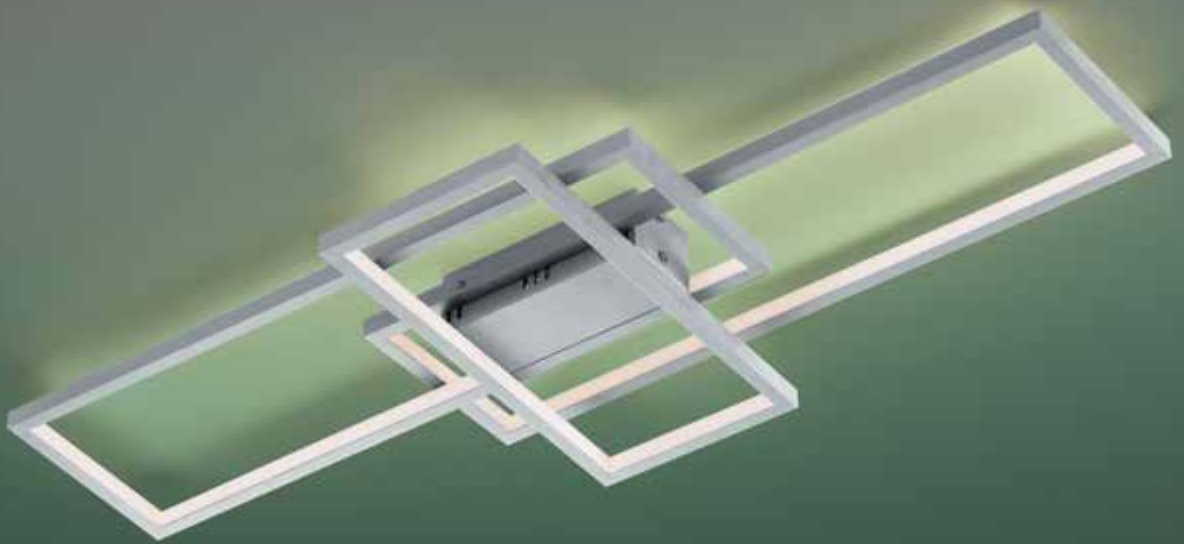
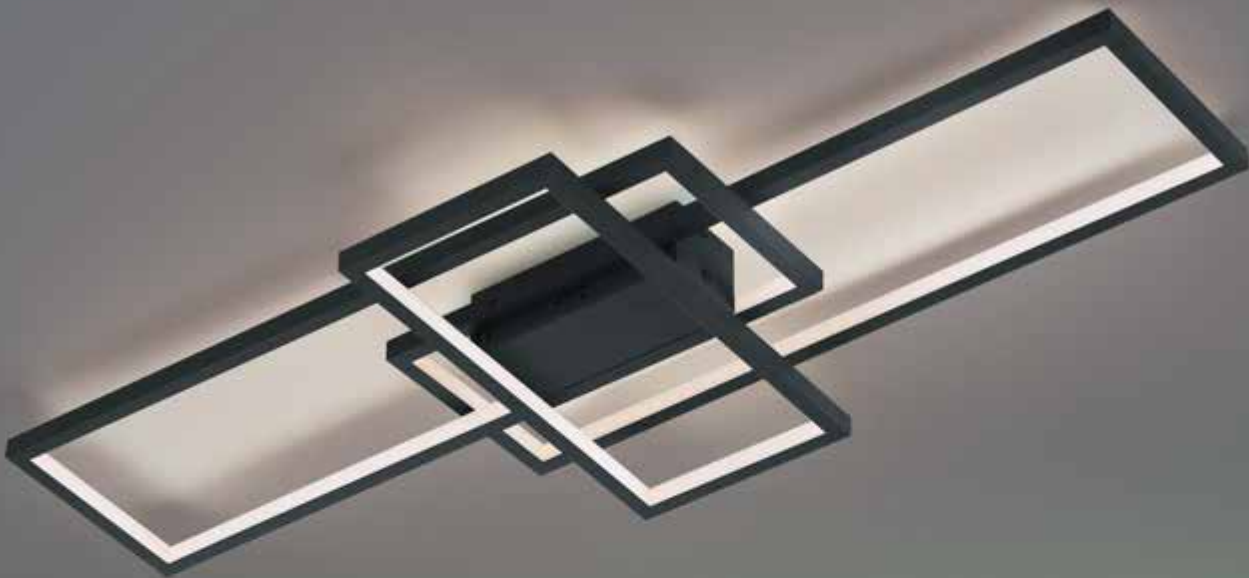

THIAGO

Metall, Nickel matt oder Anthrazit · metal, nickel mat or anthracite ·
 metals, nickel mat ou antracite · metaal, nikkel mat of antraciet ·
 metal, níquel mate o antracita · metallo, nichel opaco o antracite ·
 metal, nichel mat sau antracit · metalli, harjattu teräs tai antrasiitti ·
 metal, nikiel mat lub antracyt

SMART LIGHTING



RGBW Farbwechsler ·
 RGBW Colorchanging



Lichtfarbe stufenlos einstellbar ·
 Light color infinitely variable

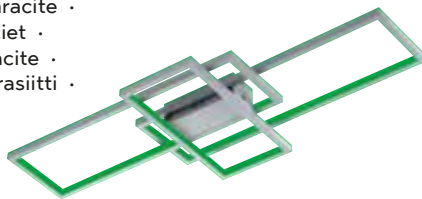

Deckenleuchte · Ceiling lamp

↔ 104 x 42 cm, ↑ 8,5 cm
 incl. RGBW-LED, 36 W
 3.000 lm, 3.000 - 6.000 K



652610307
 652610342

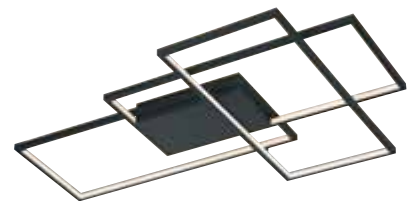

Deckenleuchte · Ceiling lamp

↔ 114 x 75 cm, ↑ 8,5 cm
 incl. RGBW-LED, 39 W
 4.500 lm, 3.000 - 6.000 K



652690307 | Nickel matt · nickel mat
 652690342 | Anthrazit · anthracite



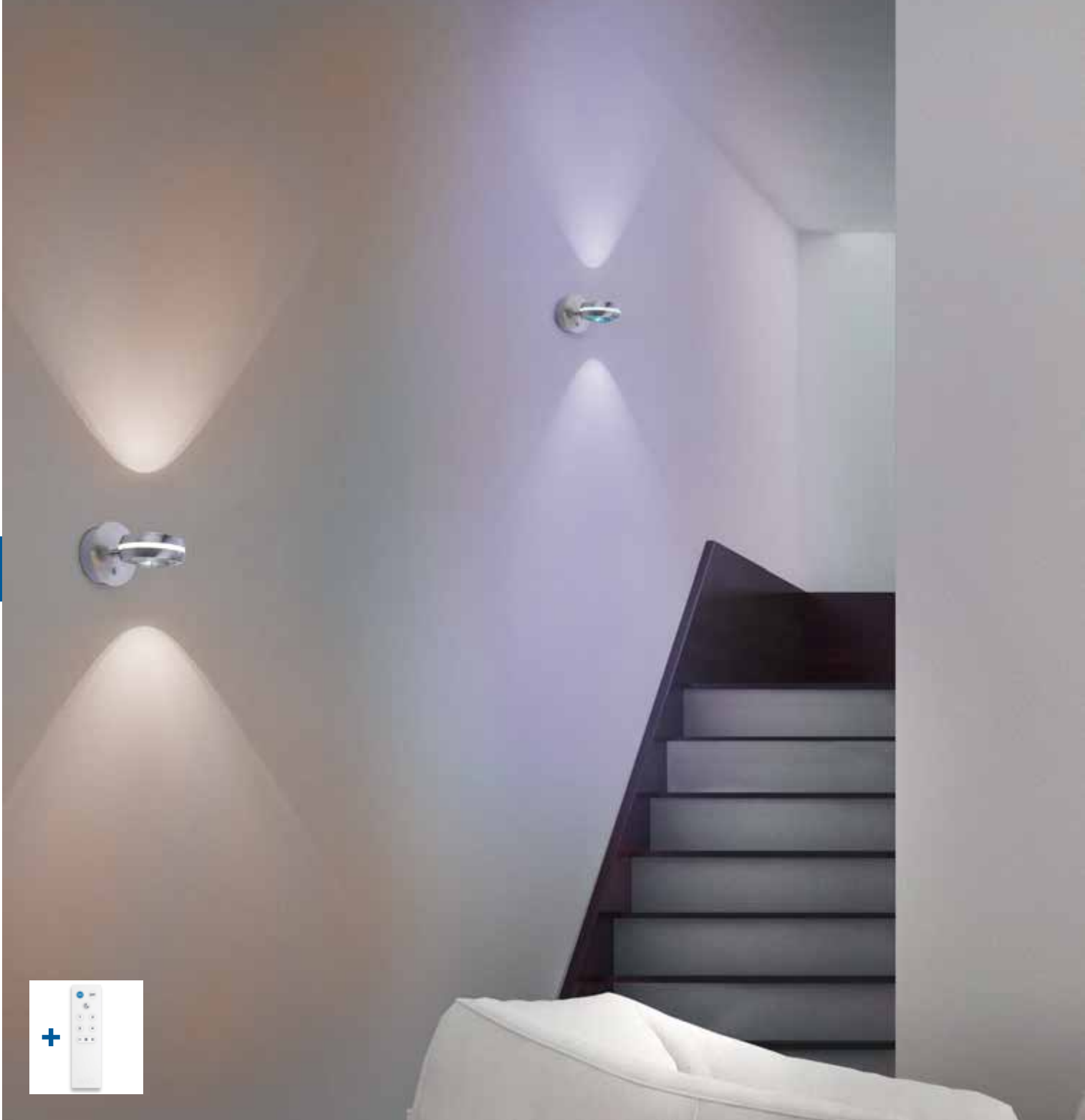

VISTA

Nickel matt · nickel mat ·
nickel mat · nikkel mat · níquel mate ·
nichel opaco · nichel mat · harjattu teräs · nikiel mat

SMART LIGHTING



RGBW Farbwechsler ·
RGBW Colorchanging



Lichtfarbe stufenlos einstellbar ·
Light color infinitely variable



Wandleuchte · Wall lamp

Ø 11 cm, ∅ 17,5 cm
incl. 2 x RGBW-LED, 3,8 W
2 x 380 lm, 3.000 - 5.000 K



255410207



MELBY

Nickel matt, Acryl · nickel mat, acryl ·
 nickel mat, acryl · nikkell mat, acryl · níquel mate, acrílico ·
 nichel opaco, acrílico · nichel mat, acrílic · harjattu teräs, akryyli · nikiel mat, akryl

Direkte und indirekte Beleuchtung · up and down lighting ·
 point lumineux en haut et en bas · lichtpunt boven en onder · luz de arriba y abajo ·
 luce su e giù · sus și în jos lumina · ylös ja alas valoa · w górę iw dół światło

SMART LIGHTING



RGBW Farbwechsler ·
 RGBW Colorchanging



Lichtfarbe stufenlos einstellbar ·
 Light color infinitely variable

Deckenleuchte · Ceiling lamp

↔ max. 242 x 10 cm, ↓ 12 cm
 incl. RGBW-LED, 23 W
 max. 2.200 lm, 3.000 - 5.000 K



651210507



GRIFFIN

Nickel matt, Acryl · nickel mat, acryl ·
 nickel mat, acryl · nikkell mat, acryl · níquel mate, acrílico · nichel opaco, acrilico ·
 nichel mat, acrilic harjattu teräs, akryyli · nikiel mat, akryl

SMART LIGHTING

 RGBW Farbwechsler ·
 RGBW Colorchanging

 Lichtfarbe stufenlos einstellbar ·
 Light color infinitely variable



Deckenleuchte · Ceiling lamp
 ↔ 39,5 x 39,5 cm, ↓ 5 cm
 incl. SMD-LED, 20 W
 2.300 lm, 3.000 - 5.500 K



657414007



Deckenleuchte · Ceiling lamp
 ↔ 59,5 x 59,5 cm, ↓ 5 cm
 incl. SMD-LED, 36 W
 4.200 lm, 3.000 - 5.500 K



657416007



Deckenleuchte · Ceiling lamp
 ↔ 109,5 x 29,5 cm, ↓ 5 cm
 incl. SMD-LED, 37 W
 4.300 lm, 3.000 - 5.500 K



657411107

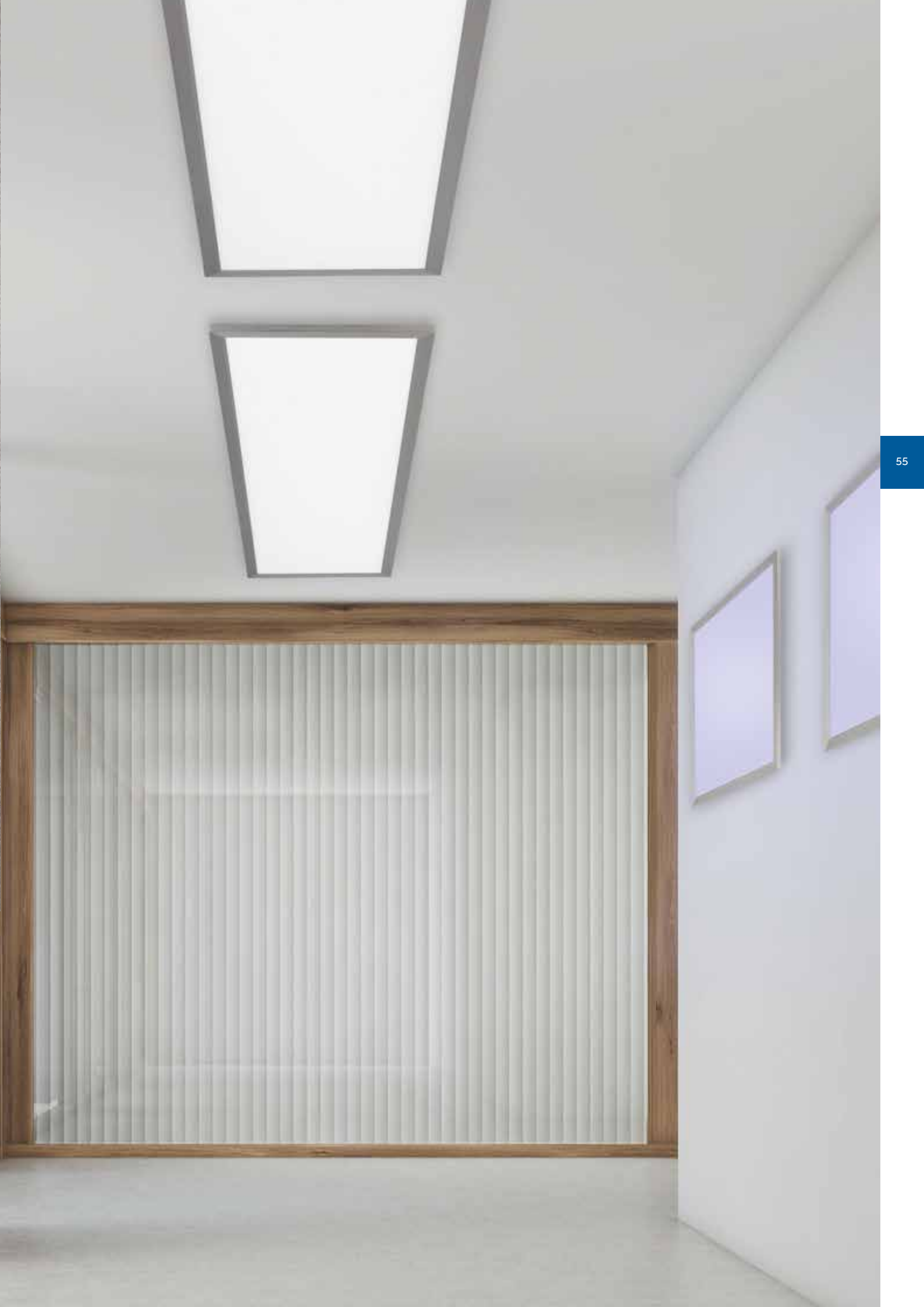

CHARLY

Acryl, weiß · acryl, white ·
acryl, blanc · acryl, wit · acrílico, blanco · acrilico, bianco ·
acrilic, alb · akryyli, valkoinen · akryl, biały

Deckenleuchte · Ceiling lamp

Ø 50 cm, ↑ 12 cm

incl. RGBW-LED, 27 W

max. 3.100 lm, 3.000 - 5.500 K



656010100

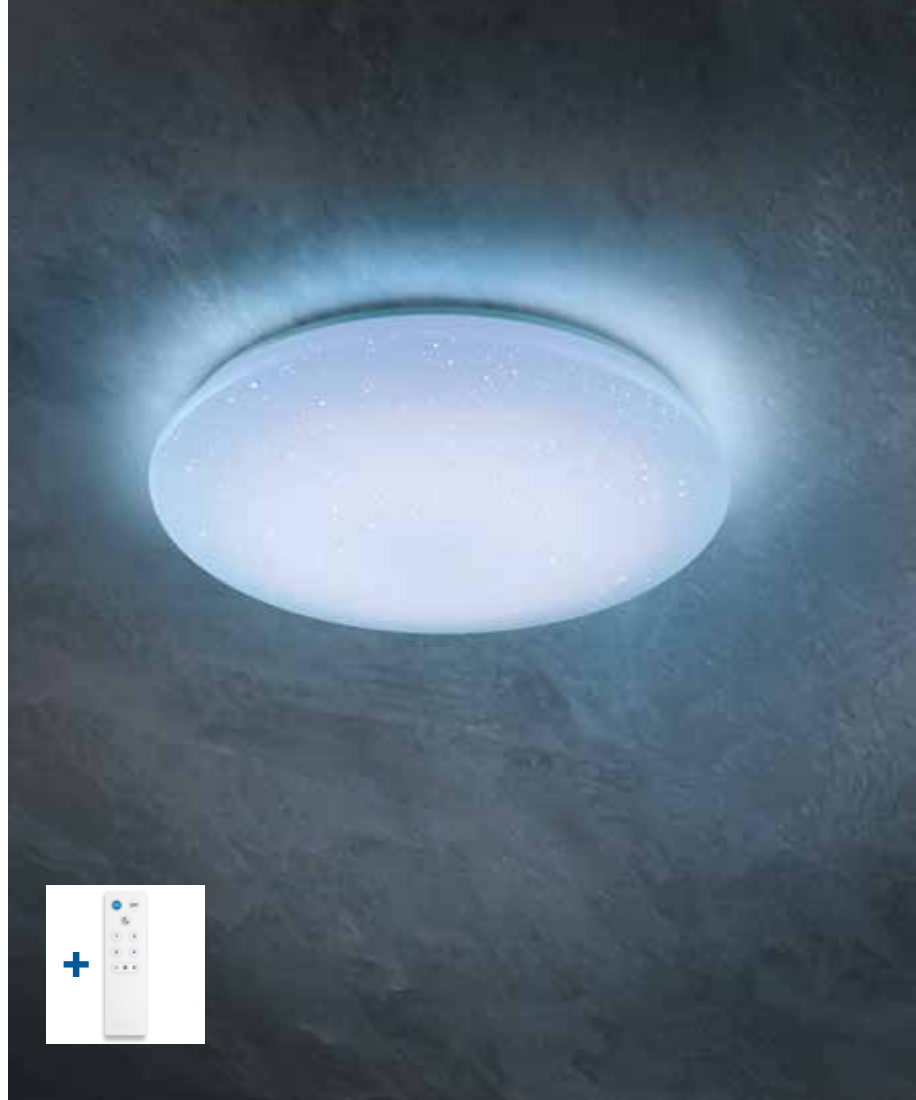

SMART LIGHTING



RGBW Farbwechsler ·
RGBW Colorchanging



Lichtfarbe stufenlos einstellbar ·
Light color infinitely variable

NALIDA

Acryl, weiß · acryl, white ·
acryl, blanc · acryl, wit · acrílico, blanco · acrilico, bianco ·
acrilic, alb · akryyli, valkoinen · akryl, biały

Deckenleuchte · Ceiling lamp

Ø 74 cm, ↑ 10 cm

incl. RGBW-LED, 40 W

max. 4.650 lm, 3.000 - 5.500 K



656090100

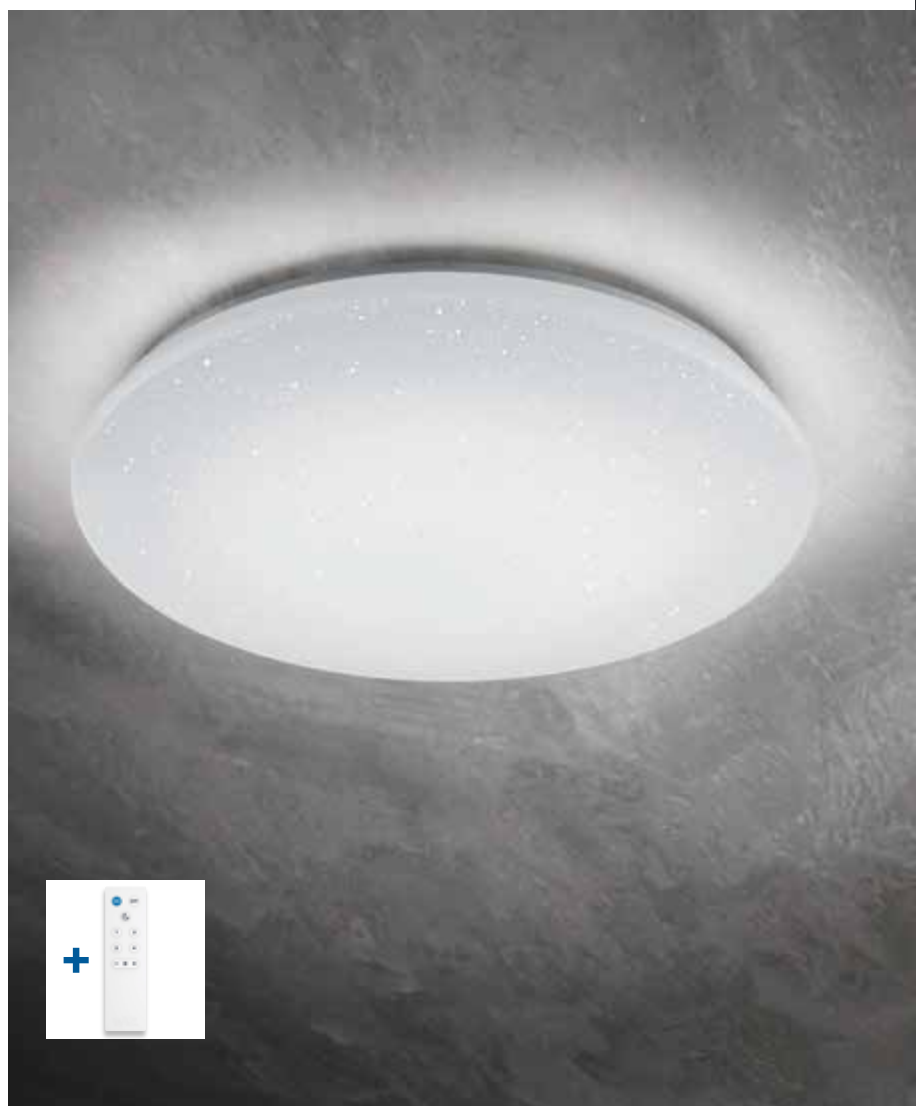

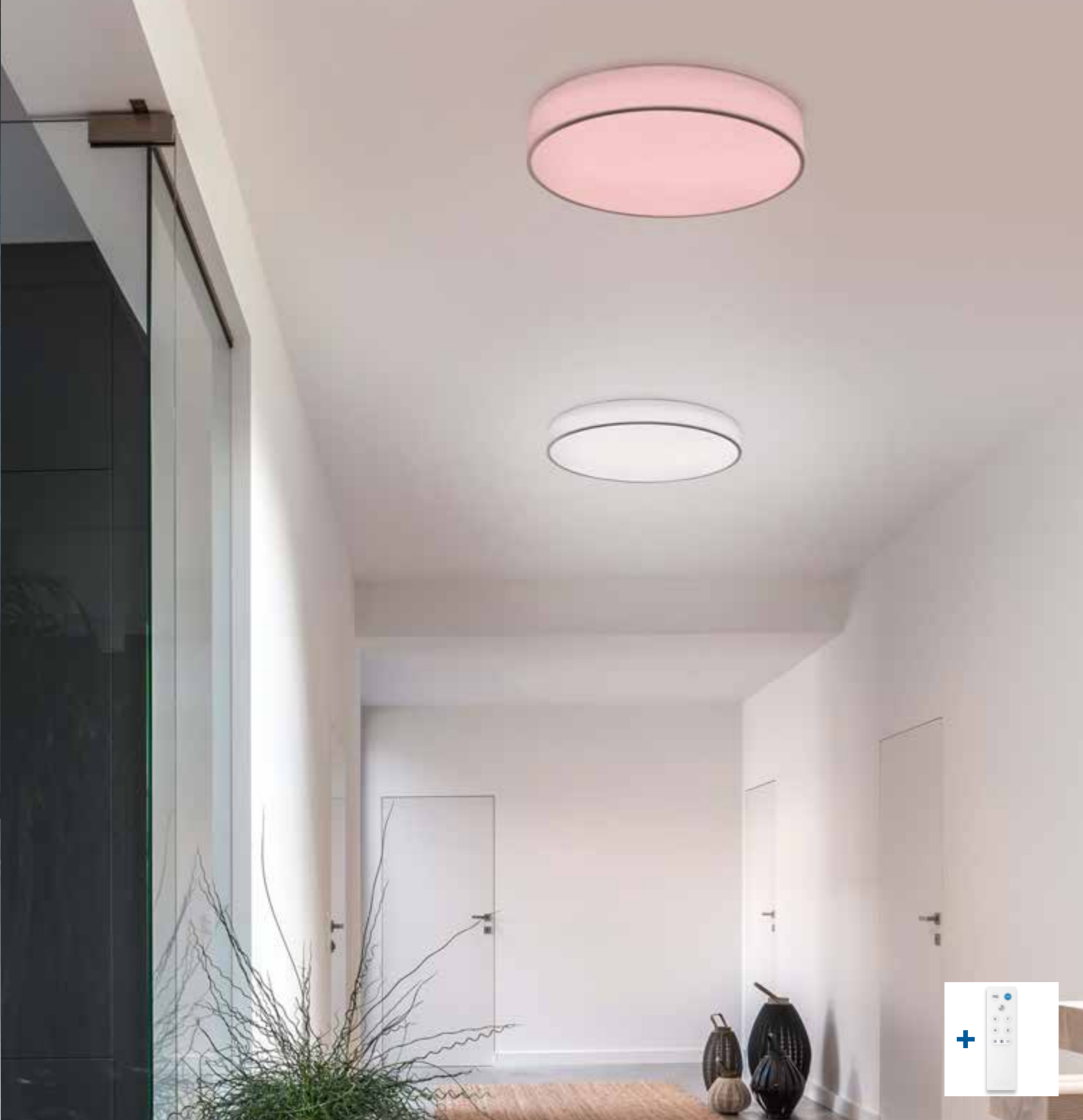

DIAMO

Stoff weiß · fabric white ·
tissu blanc · textiel wit · tela blanco · tessuto bianco ·
textil alb · tekstiili valkoinen · tkanina biały

SMART LIGHTING



RGBW Farbwechsler ·
RGBW Colorchanging



Lichtfarbe stufenlos einstellbar ·
Light color infinitely variable



Deckenleuchte · Ceiling lamp
Ø 60 cm, ↑ 10 cm
incl. RGBW-LED, 36 W
max. 3.400 lm, 3.000 - 5.000 K



651914001



Deckenleuchte · Ceiling lamp
Ø 75 cm, ↑ 10 cm
incl. 1 x RGBW-LED, 47 W
max. 5.500 lm, 3.000 - 5.000 K



651915501



Leuchtenfamilien & Kombinationen

Families & coordinates

Familles & coordonnés

Families & combinaties

Familias & coordinados

Famiglie & coordinati

Famillii & Coordonate

Tuoteperheet & yhdistettävät tuotteet

Rodzinne orawy & kombinacje





MARNIE

Metall · metal ·
metale · metaal · metal · metallo · metal · metalli · metal

05 | Aluminium gebürstet · brushed aluminium



65 | Coffee · coffee



80 | Schwarz-Gold · black-gold



Deckenleuchte · Ceiling lamp
Ø 55 cm, ↓ 21 cm
incl. SMD-LED, 58 W
6.800 lm, 3.000 K



644110105
644110165
644110180

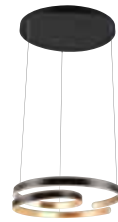

Pendelleuchte · Pendant
Ø 65 cm, ↓ 150 cm
incl. SMD-LED, 68 W
8.000 lm, 3.000 K



344110105
344110165
344110180



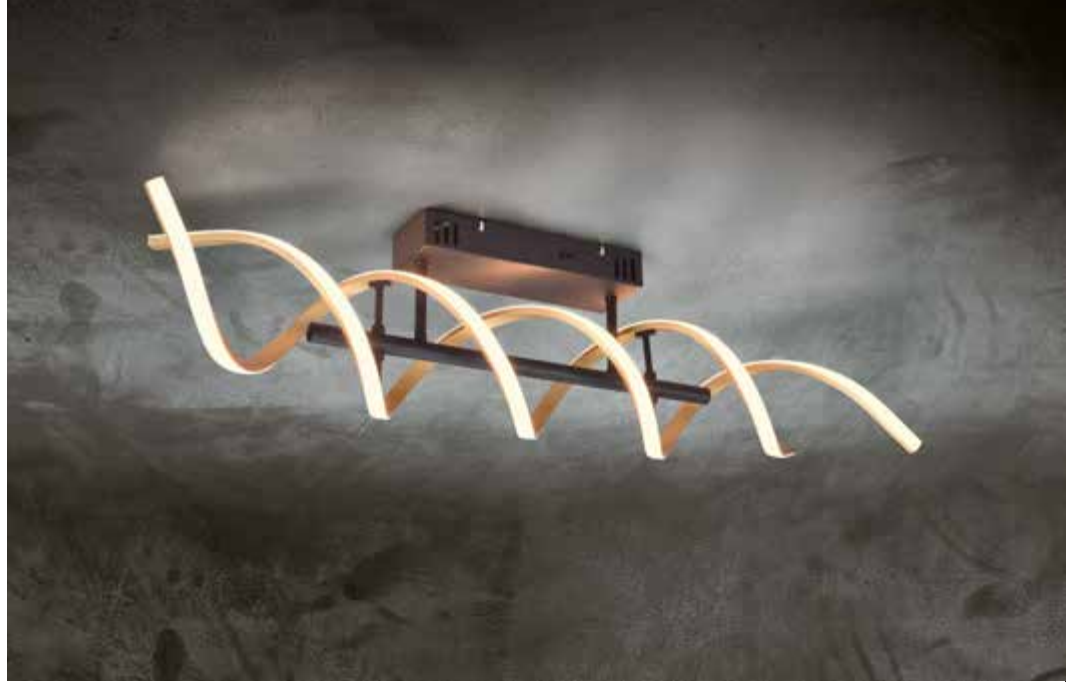
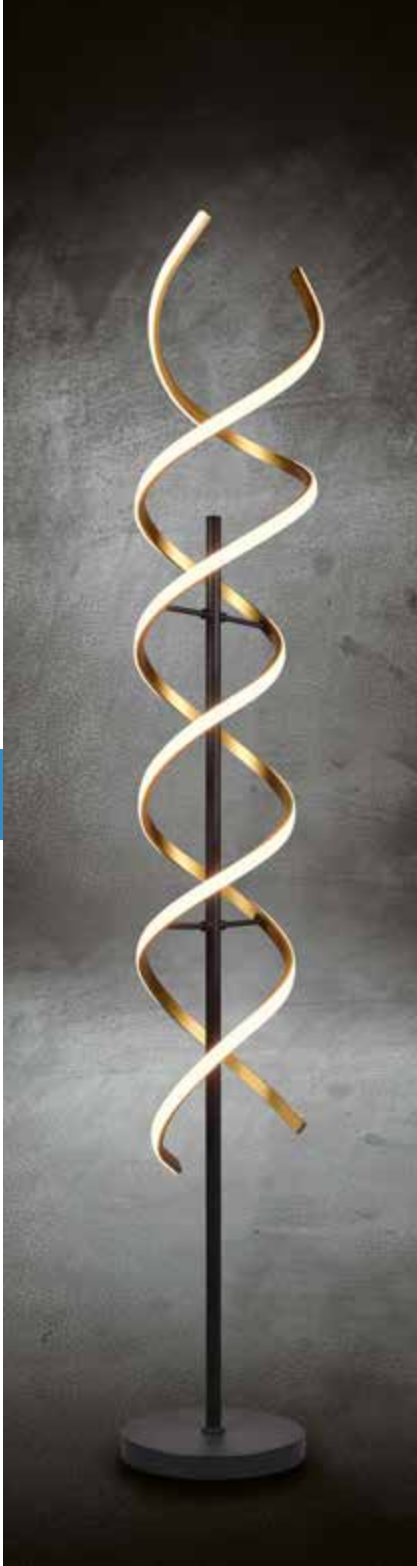

SEQUENCE

Metall, Messing matt, Schwarz matt · metal, brass mat, black mat ·
 métal, laiton mat, noir mat · metaal, messing mat, mat zwart ·
 metal, bronce mate, estera negra · metallo, ottone satinato, nero opaco ·
 metal, bronz mat, negru mat · metalli, mattamessinki, mattamusta ·
 metal, mosiądz mat, czarny mat



Lichtfarbe einstellbar ·
 Adjustable light color



2.300 K



3.000 K



4.000 K



Wandleuchte · Wall lamp
 ↓ 47 cm, ↔ 13,5 cm, ↗ 20,5 cm
 incl. SMD-LED, 22 W
 2.800 lm, 2.300 + 3.000 + 4.000 K



241810208



Deckenleuchte · Ceiling lamp
 ↔ 90 x 14,5 cm, ↓ 20,5 cm
 incl. SMD-LED, 41 W
 5.000 lm, 2.300 + 3.000 + 4.000 K



641810208



Tischleuchte · Table lamp
 ↓ 48,5 cm, Ø 16 cm
 incl. SMD-LED, 20,5 W
 2.600 lm, 2.300 + 3.000 + 4.000 K



541810208



Stehleuchte · Floor lamp
 ↓ 150 cm, Ø 23 cm
 incl. SMD-LED, 32 W
 4.000 lm, 2.300 + 3.000 + 4.000 K



441810208



Pendelleuchte · Pendant
 ↓ 150 cm, ↔ 105 x 16 cm
 incl. SMD-LED, 45 W
 5.600 lm, 2.300 + 3.000 + 4.000 K



341810208

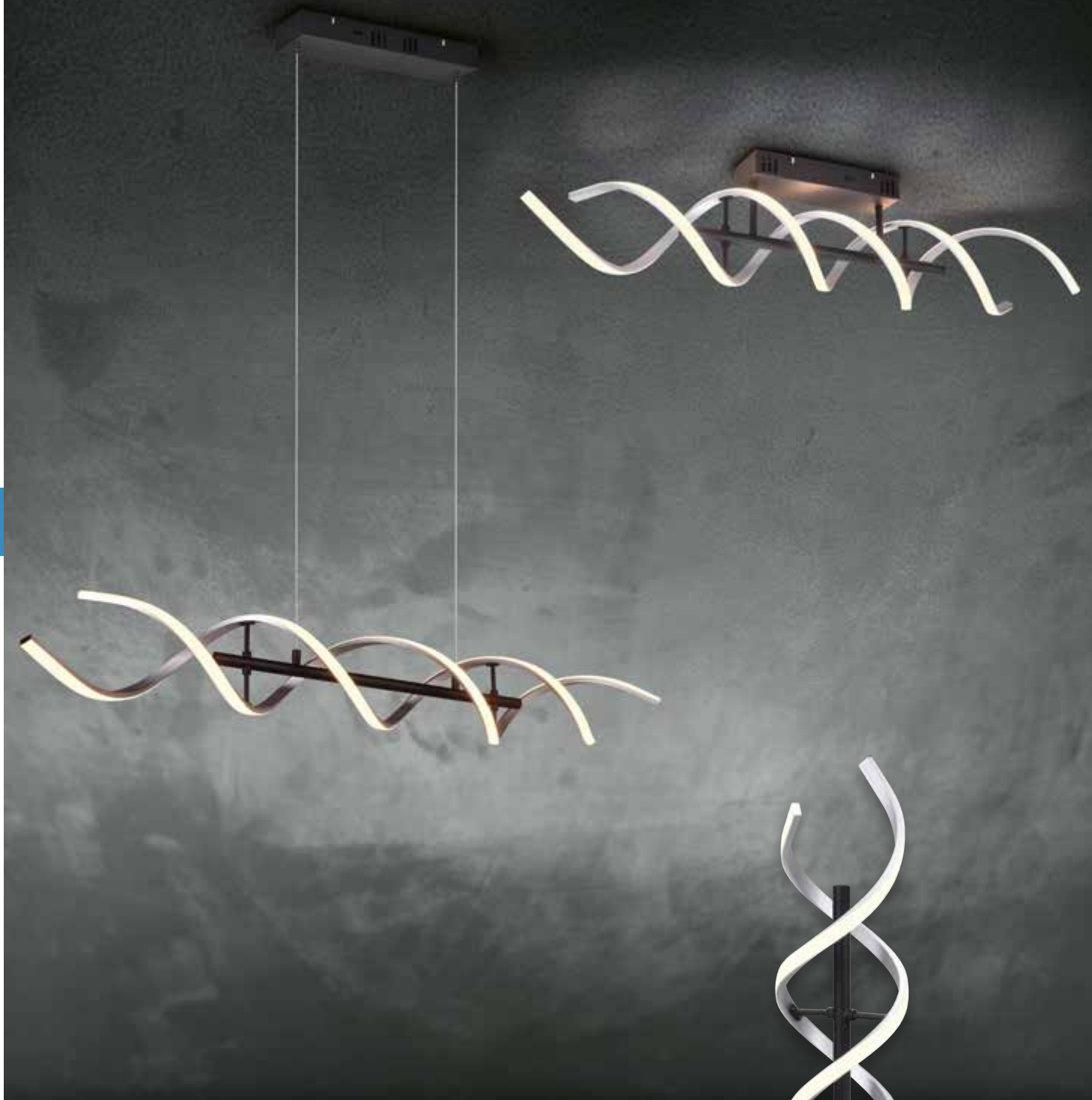

SEQUENCE

Metall, Aluminium gebürstet, Schwarz matt · metal, brushed aluminium, black mat ·
 métal, aluminium balayé, noir mat · metaal, geborsteld aluminium, mat zwart ·
 metal, aluminio pulido, estera negra · metallo, alluminio spazzolato, nero opaco ·
 metal, aluminiu lucios, negru mat · metalli, harjattu alumiini, mattamusta ·
 metal, aluminium szczotkowane, czarny mat



Lichtfarbe einstellbar ·
 Adjustable light color



2.300 K

3.000 K

4.000 K



Wandleuchte · Wall lamp
 ↓ 47 cm, ↔ 13,5 cm, ↗ 20,5 cm
 incl. SMD-LED, 22 W
 2.800 lm, 2.300 + 3.000 + 4.000 K



241810205



Deckenleuchte · Ceiling lamp
 ↔ 90 x 14,5 cm, ↓ 20,5 cm
 incl. SMD-LED, 41 W
 5.000 lm, 2.300 + 3.000 + 4.000 K



641810205



Tischleuchte · Table lamp
 ↑ 48,5 cm, Ø 16 cm
 incl. SMD-LED, 20,5 W
 2.600 lm, 2.300 + 3.000 + 4.000 K



541810205



Stehleuchte · Floor lamp
 ↑ 150 cm, Ø 23 cm
 incl. SMD-LED, 32 W
 4.000 lm, 2.300 + 3.000 + 4.000 K



441810205



Pendelleuchte · Pendant
 ↑ 150 cm, ↔ 105 x 16 cm
 incl. SMD-LED, 45 W
 5.600 lm, 2.300 + 3.000 + 4.000 K



341810205



Stehleuchte · Floor lamp
 ↑ 133 cm, Ø 23 cm, √ 41 cm
 incl. SMD-LED, 6,5 W
 650 lm, 2.700 + 3.200 + 4.000 K



426510104
 426510107
 426510108
 426510142



Pendelleuchte · Pendant
 ↑ 95 - 150 cm, Ø 14 cm
 incl. SMD-LED, 9 W
 1.050 lm, 3.000 K



326510107
 326510108
 326510142



Pendelleuchte · Pendant
 ↑ 95 - 150 cm, ↔ 55 x 14 cm
 incl. 2 x SMD-LED, 9 W
 2 x 1.050 lm, 3.000 K



326510207
 326510208
 326510242

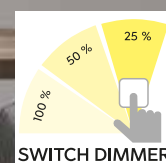

FRANKLIN

Metall · metal ·
metale · metaal · metal ·
metallo · metal · metalli · metal



Pendelleuchte · Pendant
 ↓ 95 - 150 cm, ↔ 85 x 14 cm
 incl. 3 x SMD-LED, 9 W
 3 x 1.050 lm, 3.000 K



326510307
 326510308
 326510342

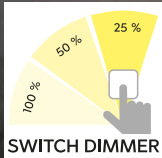

FRANKLIN

Metall · metal · metale · metaal · metal · metallo · metal · metalli · metal



04 | Altmessing · old brass

07 | Nickel matt · nickel mat

08 | Messing matt · brass mat

42 | Anthrazit · anthracite



Deckenleuchte · Ceiling lamp
 Ø 35 cm, ↑ 13 cm
 incl. 3 x SMD-LED, 8,5 W
 3 x 1.000 lm, 3.000 K



626510304
 626510307
 626510308
 626510342



Tischleuchte · Table lamp
 ↓ 25 cm, Ø 14 cm
 incl. SMD-LED, 6 W
 700 lm, 3.000 K



526510104
 526510107
 526510108
 526510142



Stehleuchte · Floor lamp
 ↑ 181 cm, Ø 35,2 cm, √ 41 cm
 incl. SMD-LED, 35 W, 4.100 lm
 incl. SMD-LED, 6,5 W, 650 lm
 2.700 + 3.200 + 4.000 K



426510204
 426510207
 426510208
 426510242



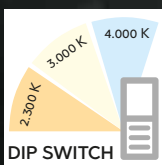

DIP SWITCH

Lichtfarben direkt an der Leuchte einstellbar · Colours directly adjustable at the lamp · Les couleurs de la lumière peuvent être réglées directement sur le luminaire · Lichtkleuren direct instelbaar op de lamp · Tonalidades de luz ajustables directamente en la lámpara · Colori della luce regolabili direttamente sulla lampada · Culori ale luminii reglabile direct de la bec · Valon väri asetettävissa suoraan valaisimesta · Barwy światła można ustawić bezpośrednio na oprawie



Deckenleuchte · Ceiling lamp
 Ø 59 cm, ↓ 14 cm
 incl. SMD-LED, 58 W
 7.000 lm, 2.300 + 3.000 + 4.000 K



626210107
626210132



Pendelleuchte · Pendant
 Ø 60 cm, ↓ 150 cm
 incl. SMD-LED, 60 W
 7.200 lm, 2.300 + 3.000 + 4.000 K



326210107
326210132



NURIA

Metall, Acryl · metal, acryl ·
metale, acryl · metaal, acryl · metal, acrílico ·
metallo, acrilico · metal, acrilic · metalli, akryyli · metal, akryl



Lichtfarbe einstellbar ·
Adjustable light color



07 | Nickel matt · nickel mat

32 | Schwarz matt · black mat



Stehleuchte · Floor lamp
↑ 150 cm, Ø 35 cm
incl. SMD-LED, 34 W
4.000 lm, 2.300 + 3.000 + 4.000 K



426219107
426219132

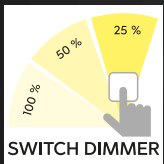

Pendelleuchte · Pendant
 Ø 62 cm, ↑ 150 cm
 incl. SMD-LED, 42 W
 5.600 lm, 3.000 K



321210107
 321210108



Deckenleuchte · Ceiling lamp
 Ø 41 cm, ↑ 14 cm
 incl. SMD-LED, 20 W
 2.500 lm, 3.000 K



621210107
 621210108



Deckenleuchte · Ceiling lamp
 Ø 62 cm, ↑ 18 cm
 incl. SMD-LED, 42 W
 5.600 lm, 3.000 K



621290107
 621290108



CHARIVARI

Nickel matt oder Messing matt · nickel mat or brass mat ·
 nickel mat ou laiton mat · nikkel mat of messing mat ·
 níquel mate o bronze mate · nichel opaco o ottone satinato ·
 nichel mat sau bronz mat · harjattu teräs tai mattamessinki ·
 nikiel mat lub mosiądz mat

07 | Nickel matt · nickel mat

08 | Messing matt · brass mat



Tischleuchte · Table lamp

↓ 50 cm, Ø 41 cm
 incl. SMD-LED, 26 W
 2.500 lm, 3.000 K



521210107
 521210108



Stehleuchte · Floor lamp

↓ 175 cm, Ø 52 cm
 incl. SMD-LED, 31 W
 4.100 lm, 3.000 K



421210107
 421210108

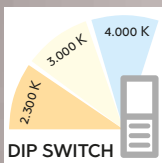

Deckenleuchte · Ceiling lamp
 ↔ 107,5 x 18 cm, ↓ 7 cm
 incl. SMD-LED, 35 W
 4.300 lm, 2.300 + 3.000 + 4.000 K



641210305
 641210308



Pendelleuchte · Pendant
 ↓ 150 cm, ↔ 107,5 x 15,5 cm
 incl. SMD-LED, 35 W
 4.300 lm, 2.300 + 3.000 + 4.000 K



341210305
 341210308



Tischleuchte · Table lamp
 ↓ 48 cm, ↔ 13,5 cm
 incl. SMD-LED, 8 W
 900 lm, 2.300 + 3.000 + 4.000 K



541210205
 541210208



Stehleuchte · Floor lamp
 ↓ 138 cm, ↔ 20,5 cm
 incl. SMD-LED, 28 W
 3.250 lm, 2.300 + 3.000 + 4.000 K



441210305
 441210308



BLAZE

Metall, Aluminium gebürstet oder Messing matt, Schwarz matt · metal, brushed aluminium or brass mat, black mat · métal, aluminium balayé ou laiton mat, noir mat · metaal, geborsteld aluminium of messing mat, mat zwart · metal, aluminio pulido o bronce mate, estera negra · metallo, alluminio spazzolato o ottone satinato, nero opaco · metal, aluminium lucios sau bronz mat, negru mat · metalli, harjattu alumiini tai mattamessinki, mattamusta · metal, aluminium szczotkowane lub mosiądz mat, czarny mat



Lichtfarbe einstellbar ·
Adjustable light color



05 | Aluminium gebürstet ·
brushed aluminium

08 | Messing matt · brass mat



2.300 K



3.000 K



4.000 K

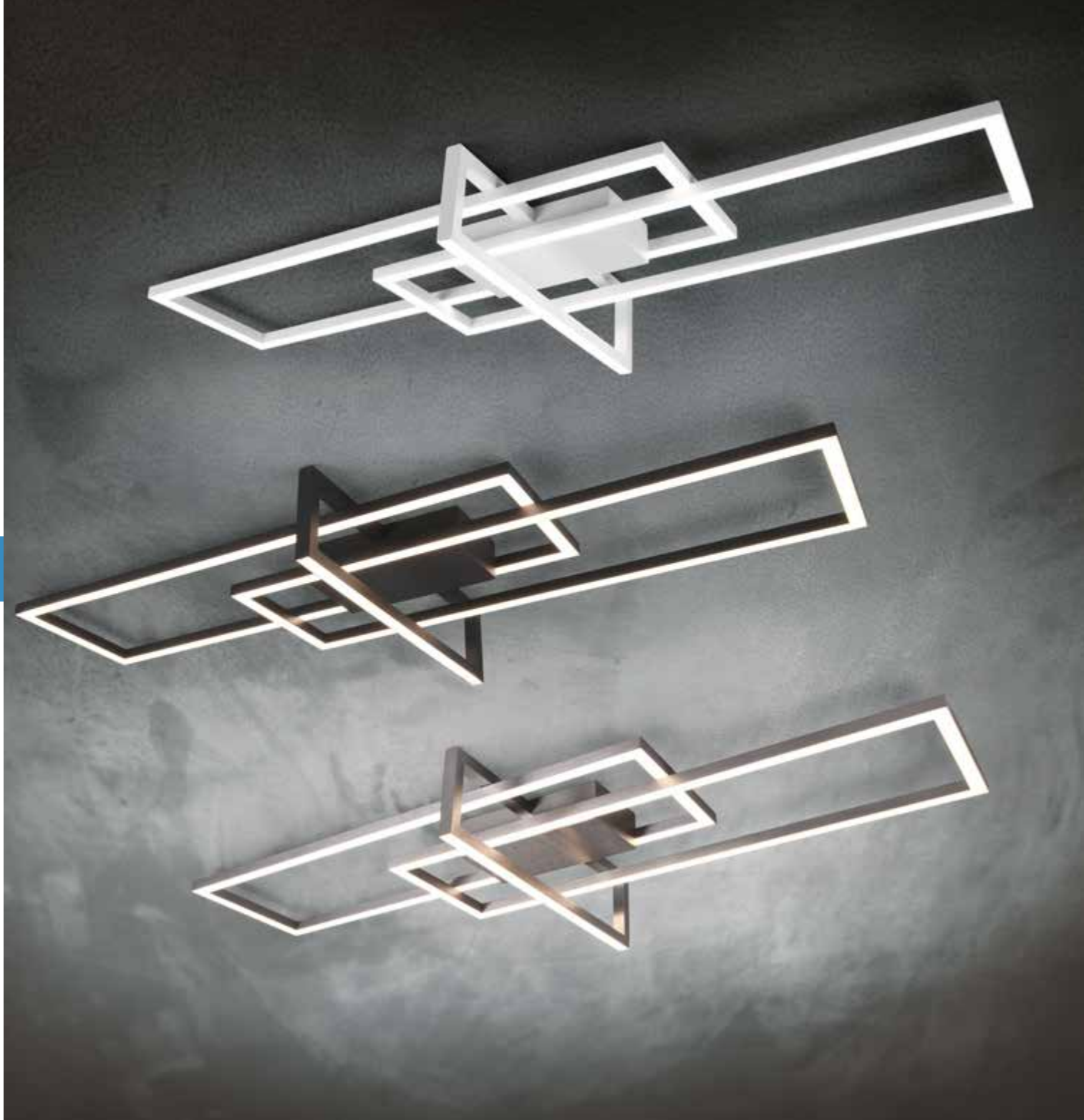

Deckenleuchte · Ceiling lamp

↔ 100 x 40 cm, ↑ 11,5 cm
incl. SMD-LED, 34 W
3.900 lm, 3.000 K
(31 = 4.100 lm, 4.000 K)



620310307
620310308
620310331
620310332



Pendelleuchte · Pendant

↓ max. 150 cm, ↔ 110 x 40 cm
incl. SMD-LED, 34 W
4.200 lm, 3.000 K
(31 = 4.400 lm, 4.000 K)



320310307
320310308
320310331
320310332

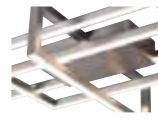

07 | Nickel matt · nickel mat

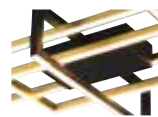

08 | Messing matt / Schwarz matt
brass matt / black mat

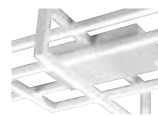

31 | Weiß matt · white mat

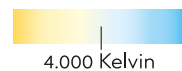

4.000 Kelvin



32 | Schwarz matt · black mat



SALINAS

Metall · metal ·
 metale · metaal · metal ·
 metallo · metal · metalli · metal

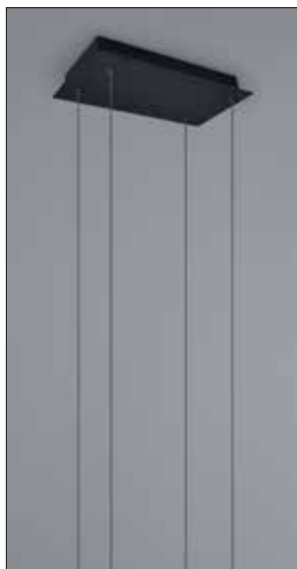
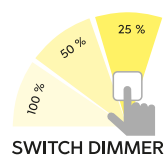



EDGE

Metall, Schwarz matt / Messing matt · metal, black mat / brass mat ·
 metallo, nero opaco / ottone satinato · metal, negro mat / bronz mat · metalli, mattamusta / mattamessinki ·
 metal, czarny mat / mosiądz mat



Lichtfarbe einstellbar ·
 Adjustable light color



Pendelleuchte · Pendant
 ↔ 118,5 x 19,3 cm, ↓ 150 cm
 incl. SMD-LED, 35 W
 4.100 lm, 2.300 + 3.000 + 4.000 K



326810132



Tischleuchte · Table lamp
 ↓ 44 cm, ↔ 21 x 17,5 cm
 incl. SMD-LED, 9 W
 950 lm, 2.300 + 3.000 + 4.000 K



526810132



Stehleuchte · Floor lamp
 ↓ 124 cm, ↔ 21 x 17,5 cm
 incl. SMD-LED, 26 W
 2.950 lm, 2.300 + 3.000 + 4.000 K



426810132



2.300 K 3.000 K 4.000 K

DIP SWITCH



FRANCIS

Metall, Aluminium gebürstet, Weiß matt oder Anthrazit · metal, brushed aluminium, white mat or anthracite ·
 metale, aluminium balayé, blanc mat ou antracite · metaal, geborsteld aluminium, wit mat of antraciet ·
 metal, aluminio pulido, estera blanca o antracita · metallo, alluminio spazzolato, bianco opaco o antracite ·
 metal, aluminiu lucios, alb mat sau antracit · metalli, harjattu alumiini, mattavalkoinen tai antrasiitti ·
 metal, aluminium szczotkowane, biały mat lub antracyt

05 | Aluminium gebürstet · brushed aluminium



31 | Weiß matt · white mat



42 | Anthrazit · anthracite



Deckenleuchte · Ceiling lamp

↔ 54 x 52 cm, ↓ 19,5 cm
 incl. SMD-LED, 40 W
 4.650 lm, 3.000 K



671310105
 671310131
 671310142



Pendelleuchte · Pendant

↔ 72 x 68 cm, ↓ 150 cm
 incl. SMD-LED, 48 W
 5.600 lm, 3.000 K



371310105
 371310131
 371310142

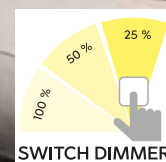

SWITCH DIMMER

OAKLAND

Metall, Nickel matt oder Anthrazit · metal, nickel mat or anthracite ·
 metale, nickel mat ou antracite · metaal, nikkel mat of antraciet · metal, níquel mate o antracita ·
 metallo, nichel opaco o antracite · metal, nichel mat sau antracit · metalli, harjattu teräs tai antrasiitti ·
 metal, nikel mat lub antracyt



07 | Nickel matt · nickel mat



42 | Anthrazit · anthracite



Deckenleuchte · Ceiling lamp
 Ø 53 cm, ↓ 23,5 cm
 incl. SMD-LED, 40 W
 5.200 lm, 3.000 K



621710107
 621710142



Pendelleuchte · Pendant
 Ø 71 cm, ↓ 150 cm
 incl. SMD-LED, 52 W
 6.200 lm, 3.000 K



321710107
 321710142

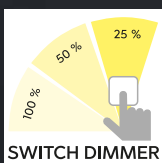

CARRERA

Metall, Acryl · metal, acryl ·
metale, acryl · metaal, acryl · metal, acrílico ·
metallo, acrilico · metal, acrilic · metalli, akryyli · metal, akryl



05 | Aluminium gebürstet · brushed aluminium



32 | Schwarz matt · black mat



Deckenleuchte · Ceiling lamp
Ø 45 cm, ↓ 22 cm
incl. SMD-LED, 38 W
4.400 lm, 3.000 K



625010105



Pendelleuchte · Pendant
↓ 150 cm, Ø 55 cm
incl. SMD-LED, 38 W
4.400 lm, 3.000 K



325010105
325010132



SYDNEY

Chrom, Acryl · chrome, acryl ·
chrome, acryl · chroom, acryl · cromo, acrílico ·
cromo, acrílico · crom, acrilic · kromi, akryyli · chrom, akryl



Deckenleuchte · Ceiling lamp

↔ 103 x 18 cm, ↑ 27 cm
incl. SMD-LED, 18 W
2.000 lm, 3.000 K



672910106



Tischleuchte · Table lamp

↑ 63 cm, Ø 20 cm
incl. SMD-LED, 12 W
1.300 lm, 3.000 K



572910106



Stehleuchte · Floor lamp

↑ 162 cm, Ø 25 cm
incl. SMD-LED, 22 W
2.500 lm, 3.000 K



472910106





2.700 K

6.000 K

JIVE

Metall, Acryl · metal, acryl ·
 metale, acryl · metaal, acryl · metal, acrílico ·
 metallo, acrilico · metal, acrylic · metalli, akryyli ·
 metal, akryl



Lichtfarbe stufenlos einstellbar ·
 Light color infinitely variable



Integrierter Dimmer ·
 Integrated dimmer



07 | Nickel matt · nickel mat



31 | Weiß matt · white mat

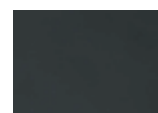

32 | Schwarz matt · black mat



Deckenleuchte · Ceiling lamp
 ↔ 50 x 45,5 cm, ↓ 7,6 cm cm
 incl. SMD-LED, 36 W
 4.300 lm, 2.700 - 6.000 K



623410207
 623410231
 623410232



Deckenleuchte · Ceiling lamp
 ↔ 80 x 73 cm, ↓ 7,6 cm
 incl. SMD-LED, 48 W
 5.600 lm, 2.700 - 6.000 K



623419207
 623419231
 623419232



Stehleuchte · Floor lamp
 ↓ 118 cm, ↔ 32 x 24 cm
 incl. SMD-LED, 23 W
 2.700 lm, 2.700 + 4.000 + 6.000 K



423410107
 423410131
 423410132

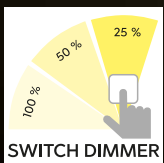

Deckenleuchte · Ceiling lamp
 ↔ 53 x 59 cm, ↑ 5,5 cm
 incl. SMD-LED, 49 W
 5.800 lm, 3.000 K



622610531
 622610532



Deckenleuchte · Ceiling lamp
 ↔ 97 x 34,3 cm, ↑ 5,5 cm
 incl. SMD-LED, 37 W
 4.800 lm, 3.000 K



622610431
 622610432

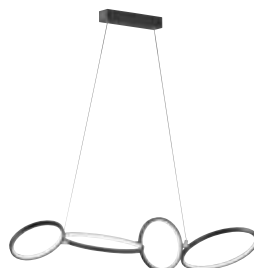

Pendelleuchte · Pendant
 ↔ 110 x 30 cm, ↑ 150 cm
 incl. SMD-LED, 37 W
 4.600 lm, 3.000 K



322610431
 322610432



RONDO

Metall, Weiß matt oder Schwarz matt · metal, white mat or black mat ·
 metals, blanc mat ou noir mat · metaal, wit mat of mat zwart ·
 metal, estera blanca o estera negra · metallo, bianco opaco o nero opaco ·
 metal, alb mat sau negru mat · metalli, mattavalkoinen tai mattamusta ·
 metal, biały mat lub czarny mat



31 | Weiß matt · white mat



32 | Schwarz matt · black mat



Tischleuchte · Table lamp

↓ 45 cm, ↔ 20,7 cm
 incl. SMD-LED, 17 W
 1.900 lm, 3.000 K



522610331
522610332



Stehleuchte · Floor lamp

↓ 115 cm, ↔ 47 cm
 incl. SMD-LED, 36 W
 4.700 lm, 3.000 K



422610531
422610532



Dimmbar ·
Dimmable

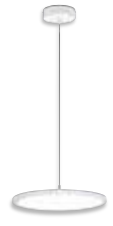

Pendelleuchte · Pendant
 ↓ 150 cm, Ø 40 cm
 incl. SMD-LED, 29 W
 3.750 lm, 4.000 K



340910131



Pendelleuchte · Pendant
 ↓ 150 cm, ↔ 90 x 17 cm
 incl. 3 x SMD-LED, 10 W
 3 x 1.250 lm, 4.000 K



340910331



Deckenleuchte · Ceiling lamp
 Ø 40 cm, ↓ 12 cm
 incl. SMD-LED, 29 W
 3.750 lm, 4.000 K



640910131



Kippbar ·
Tilttable



TRAY

Metall, weiß matt oder schwarz matt · metal, white mat or black mat ·
 metale, blanc mat ou noir mat · metaal, wit mat of mat zwart ·
 metal, estera blanca o estera negra · metallo, bianco
 opaco o nero opaco · metal, alb mat sau negru mat ·
 metalli, valkoinen matto tai musta matto · metal, biały
 mat lub czarny mat · metal, beyaz mat veya siyah mat



31 | Weiß matt · white mat

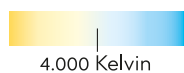

32 | Schwarz matt · black mat

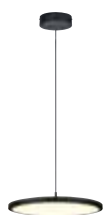

Pendelleuchte · Pendant
 ↓ 150 cm, Ø 40 cm
 incl. SMD-LED, 29 W
 3.550 lm, 3.000 K



340910132



Pendelleuchte · Pendant
 ↓ 150 cm, ↔ 90 x 17 cm
 incl. 3 x SMD-LED, 10 W
 3 x 1.200 lm, 3.000 K



340910332



Deckenleuchte · Ceiling lamp
 Ø 40 cm, ↓ 12 cm
 incl. SMD-LED, 29 W
 3.550 lm, 3.000 K



640910132



Deckenleuchte · Ceiling lamp
 Ø 40 cm, ↑ 15 cm
 excl. 3 x E27, max. 25 W



603500331
 603500332

Empfohlen:
 recommended: LED E27, 7 W
 560 lm, 3.000 K



988-700



31 | Weiß matt · white mat



32 | Schwarz matt · black mat



Wandleuchte · Wall lamp
 ↔ 40 x 13 cm, ↗ 6,5
 incl. 2 x SMD-LED, 6,5 W
 2 x 700 lm, 3.000 K

223510231
 223510232



Wandleuchte · Wall lamp
 ↔ 18 x 13 cm, ↗ 6 cm
 incl. 1 x SMD-LED, 6,5 W
 700 lm, 3.000 K

223510131
 223510132



ZANDOR

Metall, Weiß matt oder Schwarz matt, Acryl · metal, white mat or black mat, acryl ·
 metale, blanc mat ou noir mat, acryl · metaal, wit mat of mat zwart, acryl ·
 metal, estera blanca o estera negra, acrílico · metallo, bianco opaco o nero opaco, acrilico ·
 metal, alb mat sau negru mat, acrilic · metalli, mattavalkoinen tai mattamusta, akryyli ·
 metal, biały mat lub czarny mat, akryl

Pendelleuchte · Pendant
 Ø 50 cm, ↑ 150 cm
 excl. 3 x E27, max. 25 W



303500331
 303500332

Empfohlen:
 recommended: LED E27, 7 W
 560 lm, 3.000 K



988-700





BARON

Metall, Weiß matt oder Schwarz matt, Acryl · metal, white mat or black mat, acryl ·
 metale, blanc mat ou noir mat, acryl · metaal, wit mat of mat zwart, acryl ·
 metal, estera blanca o estera negra, acrílico · metallo, bianco opaco o nero opaco, acrilico ·
 metal, alb mat sau negru mat, acrilic · metalli, mattavalkoinen tai mattamusta, akryyli ·
 metal, biały mat lub czarny mat, akryl



Deckenleuchte · Ceiling lamp
 Ø 52 cm, ↑ 24 cm
 excl. 4 x E27, max. 40 W



609800431
 609800432



Pendelleuchte · Pendant
 Ø 52 cm, ↑ 150 cm
 excl. 4 x E27, max. 40 W



309800431
 309800432



31 | Weiß matt · white mat



32 | Schwarz matt · black mat





 Höhenverstellbar ·
Adjustable height

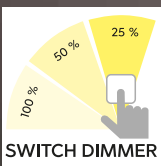

07 | Nickel matt · nickel mat



08 | Messing matt · brass mat

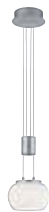

Pendelleuchte · Pendant
 ↓ 95 - 150 cm, Ø 18 cm
 incl. 1 x SMD-LED, 8 W
 900 lm, 3.000 K



342010107
342010108



Pendelleuchte · Pendant
 ↓ 95 - 150 cm, ↔ 52 cm, Ø 18 cm
 incl. 2 x SMD-LED, 8 W
 2 x 900 lm, 3.000 K



342010207
342010208



Pendelleuchte · Pendant
 ↓ 95 - 150 cm, ↔ 82 cm, Ø 18 cm
 incl. 3 x SMD-LED, 8 W
 3 x 900 lm, 3.000 K



342010307
342010308



MADISON

Metall, Glas · metal, glass ·
 metale, verre · metaal, glas · metal, vidrio ·
 metallo, vetro · metal, sticla · metalli, lasi ·
 metal, szkło



4 fach Sensorschalter
 4 level sensor switch



Tischleuchte · Table lamp
 ↑ 33 cm, Ø 18 cm
 incl. SMD-LED, 8 W
 800 lm, 3.000 K



542010107
 542010108

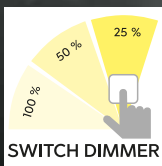

34 | Schwarz matt / Glas Weiß
black mat / glass white



32 | Schwarz matt / Glas Chrom bedampft
black mat / glass chrome plated

Tischleuchte · Table lamp
↓ 33 cm, Ø 18 cm
incl. SMD-LED, 8 W
800 lm, 3.000 K



542010132
542010134



4 fach Sensorschalter
4 level sensor switch



MADISON

Metall, Schwarz matt, Rauchglas · metal, black mat, smoked glass · métal, noir mat, verre fumé · metaal, mat zwart, rookglas · metal, estera negra, vidrio ahumado · metallo, nero opaco, vetro fume' · metal, negru mat, sticla fumurie · metalli, mattamusta, savulasi · metal, czarny mat, szkło przydymione

 Höhenverstellbar · Adjustable height

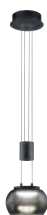

Pendelleuchte · Pendant
 ↓ 95 - 150 cm, Ø 18 cm
 incl. 1 x SMD-LED, 8 W
 900 lm, 3.000 K



342010132



Pendelleuchte · Pendant
 ↓ 95 - 150 cm, ↔ 52 cm, Ø 18 cm
 incl. 2 x SMD-LED, 8 W
 2 x 900 lm, 3.000 K



342010232



Pendelleuchte · Pendant
 ↓ 95 - 150 cm, ↔ 82 cm, Ø 18 cm
 incl. 3 x SMD-LED, 8 W
 3 x 900 lm, 3.000 K



342010332



DISCALGO

Metall, Kunststoff · metal, plastic ·
 metale, plastique · metaal, kunststof · metal, plástico ·
 metallo, plastica · metal, plastic · metalli, muovi · metal, plastik



31 | Weiß matt ·
white mat



32 | Schwarz matt ·
black mat



Deckenleuchte · Ceiling lamp
 Ø 54 cm, ↑ 30 cm
 excl. 3 x E14, max. 40 W



609900331
609900332



Pendelleuchte · Pendant
 Ø 54 cm, ↑ 150 cm
 excl. 6 x E14, max. 40 W



309900631
309900632



Metall, Glas Chrom bedampft · metal, glass chrome plated ·
 métal, verre chromé · metaal, glas verchromd · metal, vidrio acero cromado ·
 metallo, vetro cromato · metal, sticla cromat · metalli, lasi verlengbaar ·
 metal, szkło chromowany



Deckenleuchte · Ceiling lamp
 Ø 54 cm, ↓ 30 cm
 excl. 3 x E14, max. 40 W



609900357



Pendelleuchte · Pendant
 Ø 54 cm, ↓ 150 cm
 excl. 6 x E14, max. 40 W



309900657



Deckenleuchte · Ceiling lamp
 Ø 40 cm, ↓ 22 cm
 excl. 5 x G9, max. 42 W



611210506



Pendelleuchte · Pendant
 Ø 50 cm, ↓ 150 cm
 excl. 6 x G9, max. 42 W



311210606



Tischleuchte · Table lamp
 Ø 28 cm, ↓ 43 cm
 excl. 3 x G9, max. 42 W



511210306





VAPORE

Chrom, Glas chrom bedampft · chrome, chroom plated glass ·
 chrome, verre plaqué chrome · chroom, chroom opgedampt glas ·
 cromo, vidrio cromado · cromo, vetro verniciato cromo ·
 crom, sticla cromata · kromi, kromipäällystetty lasi ·
 chrom, szkło chromowane

Empfohlen:

recommended: LED G9, 3 W
 300 lm, 3.000 K



929-230



Pendelleuchte · Pendant
 Ø 40 cm, ↓ 150 cm
 excl. 5 x G9, max. 42 W



311210506



Stehleuchte · Floor lamp
 Ø 40 cm, ↓ 158 cm
 excl. 4 x G9, max. 42 W



411210406



Empfohlen:
recommended: Filament LED E14, 4 W
180 lm, 1.800 K



983-4813

LUMINA

Metall, Schwarz matt, Glas chrom bedampft · Metal, black mat, chrome plated glass ·
métal, noir mat, verre plaqué chrome · metaal, mat zwart, chroom opgedampt glas · metal, estera negra, vidrio cromado ·
metallo, nero opaco, vetro verniciato cromo · metal, negru mat, sticla cromata · metalli, mattamusta, kromipäällystetty lasi ·
metal, czarny mat, szkło chromowane



Pendelleuchte · Pendant
↔ 69 x 8,5 cm, ↓ 150 cm
excl. 3 x E14, max. 40 W



317000332



Pendelleuchte · Pendant
↔ 93 x 20 cm, ↓ 150 cm
excl. 6 x E14, max. 40 W



317000632



Pendelleuchte · Pendant
↔ 121 x 20 cm, ↓ 150 cm
excl. 8 x E14, max. 40 W



317000832



Stehleuchte · Floor lamp
↓ 200 cm, ↔ 72 cm, ↗ 68 cm
excl. 3 x E14, max. 10 W



417000332





ALICIA

Chrom, Glas rauchfarbig · chrome, glass smoke ·
 chrome, verre fumé · chrom, glas rookkleur · cromo, vidrio humo ·
 cromo, vetro fume' · crom, sticla fumuriu · kromi, lasi savu ·
 chrom, szkło przydymiony

Empfohlen:

recommended: LED G9, 2,3 W
 200 lm, 3.000 K



929-220



Deckenleuchte · Ceiling lamp
 Ø 45 cm, ↓ 46,5 cm
 excl. 12 x G9, max. 10 W



607601206



Pendelleuchte · Pendant
 ↓ 150 cm, Ø 45 cm
 excl. 12 x G9, max. 10 W



307601206



LORENA

Metall, Schwarz matt, Glas chrom bedampft · metal, black mat, chrome plated glass ·
 métal, noir mat, verre plaqué chrome · metaal, mat zwart, chroom opgedampt glas ·
 metal, estera negra, vidrio cromado · metallo, nero opaco, vetro verniciato cromo ·
 metal, negru mat, sticla cromata · metalli, mattamusta, kromipäällystetty lasi ·
 metal, czarny mat, szkło chromowane

Empfohlen:

recommended: Filament LED E27, 7 W
 806 lm, 3.000 K



987-600



Deckenleuchte · Ceiling lamp
 Ø 28,5 cm, ↑ 32 cm
 excl. 1 x E27, max. 40 W



615190132

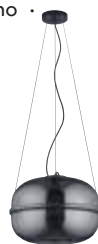

Pendelleuchte · Pendant
 ↑ 150 cm, Ø 41 cm
 excl. 1 x E27, max. 40 W



315190132



Tischleuchte · Table lamp
 ↑ 30 cm, Ø 28,5 cm
 excl. 1 x E27, max. 40 W



515190132



BALINI

Metall, Anthrazit, Rauchglas · metal, anthracite, smoked glass ·
 métal, anthracite, verre fumé · metaal, antraciet, rookglas · metal, antracita, vidrio ahumado ·
 metallo, antracite, vetro fumé · metal, antracit, sticla fumurie · metalli, antrasiitti, savulasi ·
 metal, antracyt, szkło przydymione

Empfohlen:
 recommended: Filament LED E14, 4 W
 470 lm, 2.700 K



983-400

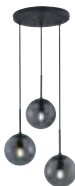

Pendelleuchte · Pendant
 Ø 30 cm, ↓ 150 cm
 excl. 3 x E14, max. 28 W



308590342



Pendelleuchte · Pendant
 ↔ 100 x 16 cm, ↓ 150 cm
 excl. 5 x E14, max. 28 W



308500542



Stehleuchte · Floor lamp
 ↓ 180 cm, ↔ 30 cm, ↗ 85 cm
 excl. 5 x E14, max. 28 W



408500542





Pendelleuchte · Pendant
 ↓ 150 cm, Ø 10 cm
 excl. 1 x E27, max. 28 W



310600132
 310600154



Pendelleuchte · Pendant
 ↓ 150 cm, Ø 37 cm
 excl. 3 x E27, max. 28 W



310630332
 310630354



Pendelleuchte · Pendant
 ↓ 150 cm, ↔ 80,5 cm
 excl. 4 x E27, max. 28 W



310600432
 310600454



Tischleuchte · Table lamp
 ↓ 25,5 cm, Ø 11 cm
 excl. 1 x E27, max. 28 W



510600132
 510600154



ROBIN

Metall, Glas · metal, glass ·
 metale, verre · metaal, glas · metal, vidrio ·
 metallo, vetro · metal, sticla · metalli, lasi · metal, szkło

32 | Schwarz matt, Glas rauchfarbig ·
 black mat, glass smoke

54 | Messing matt, Glas rauchfarbig ·
 brass mat, glass smoke

Empfohlen:
 recommended: Filament LED E27, 7 W
 400 lm, 1.800 K



986-4813





Pendelleuchte · Pendant
 ↓ 150 cm, Ø 115 cm
 excl. 6 x E14, max. 28 W



302000632
302000642



Empfohlen:
 recommended: LED E14, 3,5 W
 320 lm, 3.000 K



983-40



LED E14, 4 W
 470 lm, 2.700 K

983-400



Wandleuchte · Wall lamp
 ↓ 20,6 cm, ↗ 21,3 cm
 excl. 1 x E14, max. 28 W



202000132
202000142



Tischleuchte · Table lamp
 ↓ 52 cm, ↔ 18 cm, ↗ 24,2 cm
 excl. 1 x E14, max. 28 W



502000132
502000142

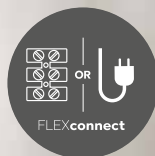

Seite/page 580



PURE

Metall, Glas · metal, glass ·
 metale, verre · metaal, glas · metal, vidrio ·
 metallo, vetro · metal, sticla · metalli, lasi · metal, szkło



32 | Schwarz matt, Glas Weiß ·
 black mat, glass white



42 | Anthazit, Rauchglas ·
 anthracite, smoked glass



Pendelleuchte · Pendant
 ↓ 150 cm, Ø 40 cm
 excl. 3 x E14, max. 28 W



302000332
302000342



Stehleuchte · Floor lamp
 ↓ 150 cm, ↔ 25 cm, ⚡ 31,7 cm
 excl. 1 x E14, max. 28 W



402000132
402000142



PURE

Messing matt, Glas Weiß · brass mat, glass white ·
 laiton mat, verre blanc · messing mat, glas wit · bronze mate, vidrio blanco · ottone satinato, vetro bianco ·
 bronz mat, sticla alb · mattamessinki, lasi valkoinen · mosiądz mat, szkło biały



Wandleuchte · Wall lamp
 ↓ 20,6 cm, ↗ 21,3 cm
 excl. 1 x E14, max. 28 W



202000108



Pendelleuchte · Pendant
 ↓ 150 cm, Ø 40 cm
 excl. 3 x E14, max. 28 W



302000308



Pendelleuchte · Pendant
 ↓ 150 cm, Ø 115 cm
 excl. 6 x E14, max. 28 W



302000608



Tischleuchte · Table lamp
 ↓ 52 cm, ↔ 18 cm, ↗ 24,2 cm
 excl. 1 x E14, max. 28 W



502000108



Stehleuchte · Floor lamp
 ↓ 150 cm, ↔ 25 cm, ↗ 31,7 cm
 excl. 1 x E14, max. 28 W



402000108



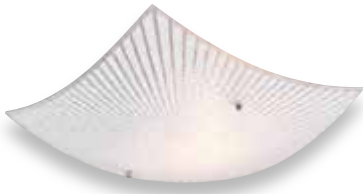

Deckenleuchte · Ceiling lamp
↔ 30 x 30 cm, ↓ 9 cm
excl. 1 x E27, max. 40 W



612200100



Deckenleuchte · Ceiling lamp
↔ 40 x 40 cm, ↓ 9,5 cm
excl. 2 x E27, max. 40 W



612200200



Wandleuchte · Wall lamp
↓ 22 cm, ↔ 20 cm, ↗ 8,5 cm
excl. 1 x E27, max. 40 W



212200100



ELISA

Metall, Glas · metal, glass ·
métal, verre · metaal, glas · metal, vidrio · metallo, vetro · metal, sticla · metalli, lasi · metal, szkło



Pendelleuchte · Pendant
↓ 150 cm, ↔ 40 x 20 cm
excl. 2 x E27, max. 40 W



312200200

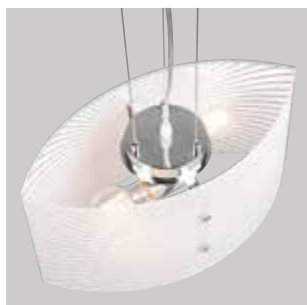

Empfohlen:
recommended: Filament LED E27, 4 W
470 lm, 2.700 K



987-400



Deckenleuchte · Ceiling lamp
 ↔ 30 x 30 cm, ↓ 9 cm
 excl. 1 x E27, max. 40 W



604400101



Deckenleuchte · Ceiling lamp
 ↔ 40 x 40 cm, ↓ 9,5 cm
 excl. 2 x E27, max. 40 W



604400201



Wandleuchte · Wall lamp
 ↔ 30 x 22 cm, ↗ 7,5 cm
 excl. 1 x E27, max. 40 W



204400101

SPIRELLI

Chrom, Dekorglas Weiß · chrome, glas decorated white ·
 chrome, verre décoré blanc · chrom, decoratief glas wit · cromo, vidrio decorado blanco ·
 cromo, vetro decorato bianco · crom, sticla decorativa alb · kromi, ornamenttilasi valkoinen ·
 chrom, szkło dekoracyjne biały



Pendelleuchte · Pendant
 ↔ 40 x 20 cm, ↓ 150 cm
 excl. 2 x E27, max. 40 W



304400201



SANDRINA

Dekorglas · glas decorated ·
 verre décoré · decoratief glas · vidrio decorado ·
 vetro decorato · sticla decorativa · ornamenttilasi · szkło dekoracyjne



Wandleuchte · Wall lamp
 ↔ 30 x 15 cm, ↗ 8 cm
 excl. 1 x E27, max. 40 W



201200100



Deckenleuchte · Ceiling lamp
 Ø 30 cm, ↓ 9 cm
 excl. 1 x E27, max. 40 W



601200100



Deckenleuchte · Ceiling lamp
 Ø 40 cm, ↓ 10 cm
 excl. 2 x E27, max. 40 W



601200200



Pendelleuchte · Pendant
 Ø 50 cm, ↓ 150 cm
 excl. 3 x E27, max. 40 W



301200300



SIGNA

Chrom, Dekorglas Weiß · chrome, glas decorated white ·
 chrome, verre décoré blanc · chrom, decoratief glas wit ·
 cromo, vidrio decorado blanco · cromo, vetro decorato bianco ·
 crom, sticla decorativa alb · kromi, ornamenttilasi valkoinen ·
 chrom, szkło dekoracyjne biały



Wandleuchte · Wall lamp
 ↔ 20 x 30 cm, ↗ 9 cm
 excl. 1 x E27, max. 40 W



202500101



Deckenleuchte · Ceiling lamp
 ↔ 30 x 30 cm, ↓ 9 cm
 excl. 1 x E27, max. 40 W



602500101



Deckenleuchte · Ceiling lamp
 ↔ 40 x 40 cm, ↓ 9,5 cm
 excl. 2 x E27, max. 40 W



602500201



Pendelleuchte · Pendant
 Ø 50 cm, ↓ 150 cm
 excl. 3 x E27, max. 40 W



302500301



CAMDEN

Nickel matt, Stoffschirm · nickel mat, fabric shade ·
 nickel mat, abat-jour tissu · nikkel mat, Stoffen kap · níquel mate,
 Pantalla de tela · nichel opaco, paralume in tessuto · nichel mat, abajur textil ·
 harjattu teräs, kangas varjostin · nikiel mat, Klosz z materiału



Deckenleuchte · Ceiling lamp
 Ø 65 cm, ↑ 35 cm
 excl. 3 x E27, max. 60 W



608300307



Pendelleuchte · Pendant
 Ø 65 cm, ↑ 150 cm
 excl. 3 x E27, max. 60 W



308300307



Stehleuchte · Floor lamp
 ↑ 145 - 187 cm, Ø 65 cm
 excl. 3 x E27, max. 60 W



408300307

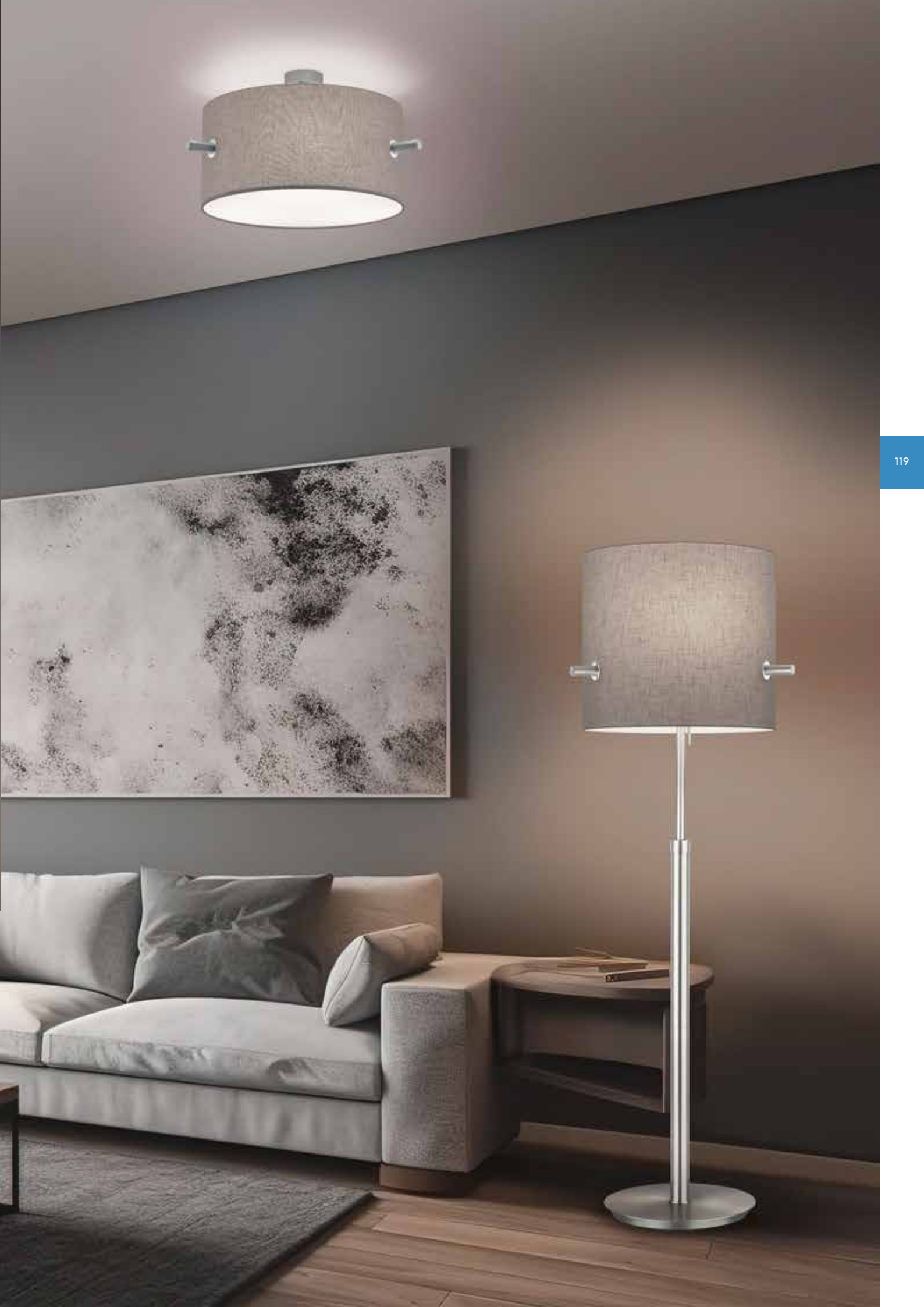



CAMDEN

Messing matt, Stoffschirm · brass mat, fabric shade ·
 laiton mat, abat-jour tissu · messing mat, Stoffen kap ·
 bronze mate, Pantalla de tela · ottone satinato, paralume in tessuto ·
 bronz mat, abajur textil · mattamessinki, kangas varjostin ·
 mosiądz mat, Klosz z materiału



Deckenleuchte · Ceiling lamp
 Ø 65 cm, ↑ 35 cm
 excl. 3 x E27, max. 60 W



608300308



Pendelleuchte · Pendant
 Ø 65 cm, ↑ 150 cm
 excl. 3 x E27, max. 60 W



308300308



Stehleuchte · Floor lamp
 ↑ 145 - 187 cm, Ø 65 cm
 excl. 3 x E27, max. 60 W



408300308





Wandleuchte · Wall lamp

↓ 32,5 x 25,5 cm, ↗ 69 cm
excl. 1 x E27, max. 60 W



209100107
209100108

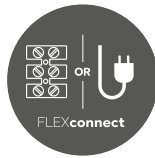

Seite/page 580



07 | Nickel matt ·
nickel mat



08 | Messing matt ·
brass mat

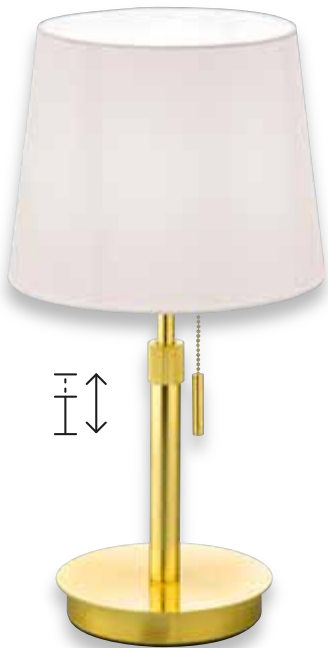

Tischleuchte · Table lamp

↓ 45 - 56 cm, Ø 25,5 cm
excl. 1 x E27, max. 60 W



509100107
509100108





LYON

Nickel matt oder Messing matt, Stoffschild · nickel mat or brass mat, fabric shade ·
 nickel mat ou laiton mat, abat-jour tissu · nikkell mat of messing mat, Stoffen kap ·
 níquel mate o bronce mate, Pantalla de tela · nichel opaco o ottone satinato, paralume in tessuto ·
 nichel mat sau bronz mat, abajur textil · harjattu teräs tai mattamessinki, kangas varjostin ·
 nikiel mat lub mosiądz mat, Klosz z materiału



Getrennt schaltbar · Separately switchable ·
 Interrupteurs séparés · Gescheiden schakelbaar ·
 Interruptores separados · Interruttori separati ·
 Intrerupatoare separate · Erikseen kytkettävissä ·
 Oddzileny przełącznik



Stehleuchte · Floor lamp
 ↑ 138 - 180 cm, Ø 46,3 cm
 excl. 3 x E27, max. 60 W



409100307
 409100308



01



02



11

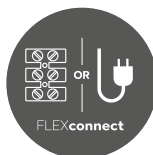

Seite/page 580



01 | Weiß · white



02 | Schwarz · black



11 | Grau · grey

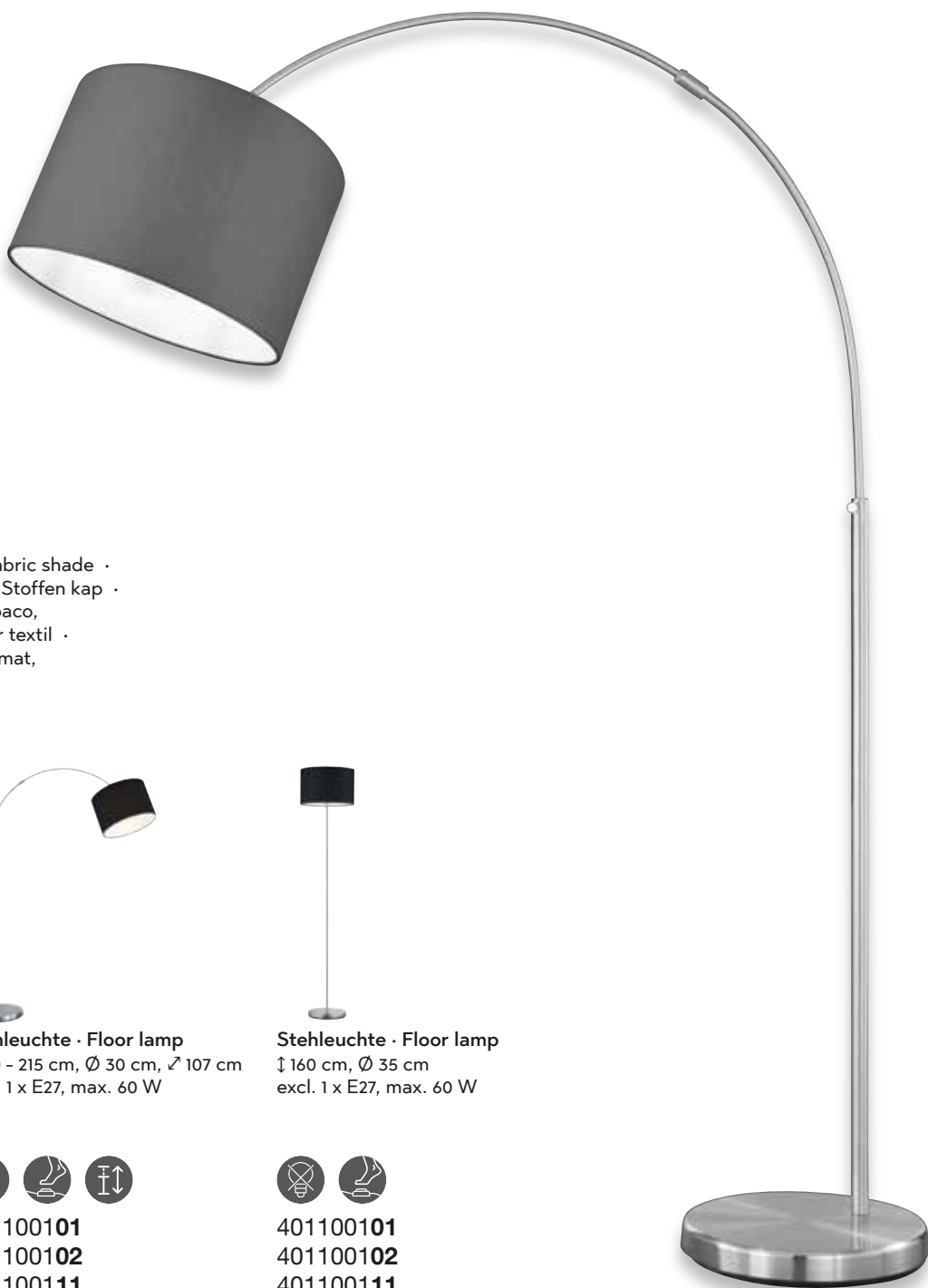

HOTEL

Nickel matt, Stoffschirm · nickel mat, fabric shade ·
nickel mat, abat-jour tissu · nikkell mat, Stoffen kap ·
níquel mate, Pantalla de tela · nichel opaco,
paralume in tessuto · nichel mat, abajur textil ·
harjattu teräs, kangas varjostin · nikiel mat,
Klosz z materiału



Wandleuchte · Wall lamp
↓ 23,5 x 20 cm, ∠ max. 34,5 cm
incl. 1 x SMD-LED, 3,1 W
310 lm, 3.000 K
excl. 1 x E14, max. 40 W



271170201
271170202
271170211



Stehleuchte · Floor lamp
↓ 150 - 215 cm, Ø 30 cm, ∠ 107 cm
excl. 1 x E27, max. 60 W



461100101
461100102
461100111



Stehleuchte · Floor lamp
↓ 160 cm, Ø 35 cm
excl. 1 x E27, max. 60 W



401100101
401100102
401100111

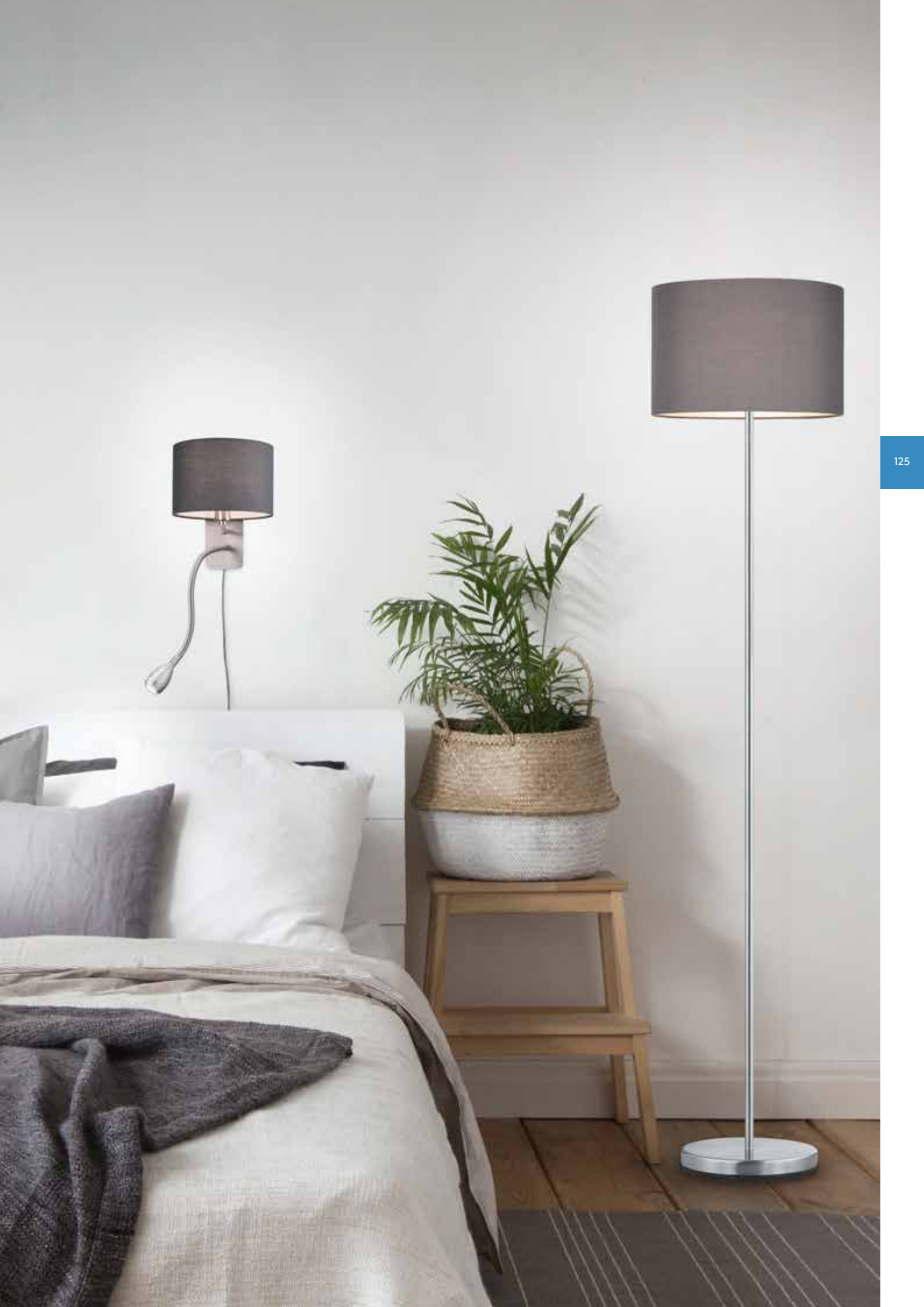



HOTEL

Nickel matt, Stoff · nickel mat, fabric ·
 nickel mat, tissu · nikkel mat, textiel · níquel mate, tela ·
 nichel opaco, tessuto · nichel mat, textil · harjattu teräs, tekstiili · nikiel mat, tkanina



01 | Weiß · white



02 | Schwarz · black



11 | Grau · grey



Deckenleuchte · Ceiling lamp
 Ø 50 cm, ↓ 17 cm
 excl. 3 x E27, max. 60 W



603900301
 603900302
 603900311



Deckenleuchte · Ceiling lamp
 Ø 65 cm, ↓ 17 cm
 excl. 5 x E27, max. 60 W



603900501
 603900502
 603900511



HOTEL

Stoffschirm, mehrfarbig · fabric shade, multicolor ·
 abat-jour tissu, multicolore · Stoffen kap, multicolor · Pantalla de tela, multicolor ·
 paralume in tessuto, multicolore · abajur textil, multicolor · kangas varjostin, monivärinen · Klosz z materiału, multi-kolor

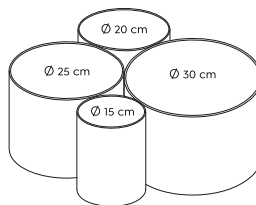

Deckenleuchte · Ceiling lamp
 ↔ 50,5 x 47 cm, ↓ 21,5 cm
 excl. 4 x E27, max. 42 W



693900417

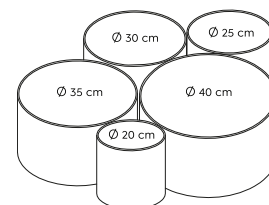

Deckenleuchte · Ceiling lamp
 ↔ 90 x 70 cm, ↓ 21,5 cm
 excl. 5 x E27, max. 42 W



693900517



HOTEL

Nickel matt, Stoffschirm Weiß oder Schwarz · nickel mat, fabric shade white or black ·
 nickel mat, abat-jour tissu blanc ou noir · nikkell mat, stoffen kap wit of zwart ·
 níquel mate, pantalla de tela blanco o negro · nichel opaco, paralume in tessuto bianco o nero ·
 nichel mat, abajur textil alb sau negru · harjattu teräs, kangas varjostin valkoinen tai musta ·
 nikiel mat, klosz z materiału biały lub czarny



01 | Weiß · white



02 | Schwarz · black



Tischleuchte · Table lamp
 ↓ 32 cm, Ø 20 cm
 excl. 1 x E14, max. 40 W



501100101
 501100102



Tischleuchte · Table lamp
 ↓ 55 cm, Ø 30 cm
 excl. 1 x E27, max. 60 W



511100101
 511100102



01 | Nickel matt, Schirm Weiß · nickel mat, shade white



08 | Messing matt, Schirm Creme-Weiß · brass mat, shade cream white



11 | Nickel matt, Schirm Grau · nickel mat, shade grey



Stehleuchte · Floor lamp
 ↑ 170 cm, Ø 40 cm, ↗ 35 cm
 excl. 1 x E27, max. 60 W
 excl. 1 x E14, max. 18 W



403900201
 403900208
 403900211

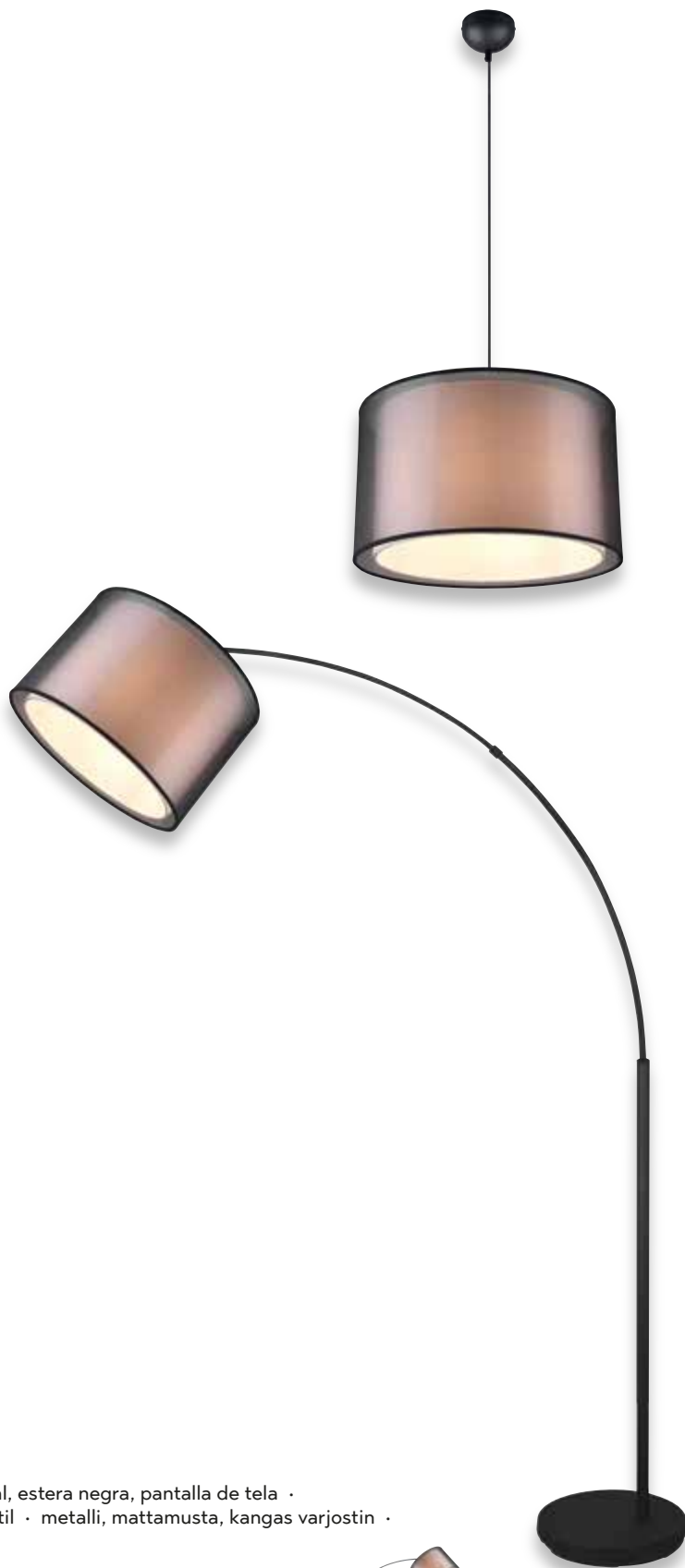

BURTON

Metall, Schwarz matt, Stoffschirm · metal, black mat, fabric shade ·
 métal, noir mat, abat-jour tissu · metaal, mat zwart, stoffen kap · metal, estera negra, pantalla de tela ·
 metallo, nero opaco, paralume in tessuto · metal, negru mat, abajur textil · metalli, mattamusta, kangas varjostin ·
 metal, czarny mat, klosz z materiału



Pendelleuchte · Pendant
 ↓ 150 cm, Ø 45 cm
 excl. 1 x E27, max. 40 W



311400132

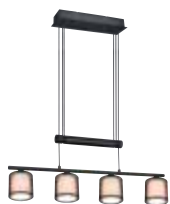

Pendelleuchte · Pendant
 ↓ 95 - 150 cm, ↔ 82,5 x 12,5 cm
 excl. 4 x E14, max. 28 W



311400432



Tischleuchte · Table lamp
 ↓ 28,5 cm, Ø 12,5 cm
 excl. 1 x E14, max. 28 W



511400132



Stehleuchte · Floor lamp
 ↓ 171 cm, Ø 35 cm, ↗ 120 cm
 excl. 1 x E27, max. 40 W



411490132





Seite/page 580

BURTON

Metall, Schwarz matt, Stoffschirm · metal, black mat, fabric shade ·
 métal, noir mat, abat-jour tissu · metaal, mat zwart, stoffen kap · metal, estera negra, pantalla de tela ·
 metallo, nero opaco, paralume in tessuto · metal, negru mat, abajur textil · metalli, mattamusta, kangas varjostin ·
 metal, czarny mat, klosz z materiału



Strahler · Spot
 ↓ 19,5 cm, ↔ 12 cm, ↗ 18,5 cm
 excl. 1 x E14, max. 28 W



811400132



Strahler · Spot
 ↔ 32,5 x 18 cm, ↓ 19,5 cm
 excl. 2 x E14, max. 28 W



811400232



Strahler · Spot
 ↔ 71,5 x 18 cm, ↓ 19,5 cm
 excl. 4 x E14, max. 28 W



811400432



Strahler · Spot
 Ø 49 cm, ↓ 22 cm
 excl. 3 x E14, max. 28 W



811430332



Deckenleuchte · Ceiling lamp
 Ø 50 cm, ↓ 25 cm
 excl. 3 x E27, max. 40 W



611400332





BURTON

Metall, Schwarz matt, Stoffschirm · metal, black mat, fabric shade ·
 métal, noir mat, abat-jour tissu · metaal, mat zwart, stoffen kap · metal, estera negra, pantalla de tela ·
 metallo, nero opaco, paralume in tessuto · metal, negru mat, abajur textil · metalli, mattamusta, kangas varjostin ·
 metal, czarny mat, klosz z materiału



Deckenleuchte · Ceiling lamp
 ↔ 65 x 55 cm, ↓ 21,5 cm
 excl. 3 x E27, max. 40 W



611490332

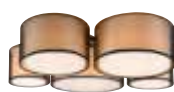

Deckenleuchte · Ceiling lamp
 ↔ 90 x 70 cm, ↓ 21,5 cm
 excl. 5 x E27, max. 40 W



611400532



Stehleuchte · Floor lamp
 ↓ 150 cm, Ø 35 cm
 excl. 1 x E27, max. 40 W



411400132



Stehleuchte · Floor lamp
 ↓ 174 cm, Ø 45 cm
 excl. 1 x E27, max. 60 W
 excl. 1 x E14, max. 40 W



411400232





Deckenleuchte · Ceiling lamp
Ø 30 cm, ↓ 22 cm
excl. 2 x E14, max. 40 W



608200279



Tischleuchte · Table lamp
↑ 33 cm, Ø 20 cm
excl. 1 x E27, max. 40 W



508200179



Stehleuchte · Floor lamp
↑ 160,5 cm, Ø 35 cm
excl. 1 x E27, max. 60 W



408200179



HOSTEL

Metall, Stoffschirm innen goldfarbig · metal, fabric shade gold colored inside ·
 metale, abat-jour tissu Or · metaal, Stoffen kap Binnenkant goudkleur ·
 metal, Pantalla de tela Interior en color dorado · metallo, paralume in tessuto
 interno colore oro · metal, abajur textil interior culoare aurie · metalli, kangas
 varjostin sisäosa kullanvärinen · metal, Klosz z materiału wewnątrz złoty



Pendelleuchte · Pendant
 Ø 40 cm, ↓ 150 cm
 excl. 1 x E27, max. 60 W



308200179



Stehleuchte · Floor lamp
 ↓ max. 156 cm, Ø 35 cm, ↗ max. 63 cm
 excl. 1 x E27, max. 60 W



408290179



Deckenleuchte · Ceiling lamp
 ↔ 75 x 44,2 cm, ↑ 22 cm
 excl. 5 x E14, max. 25 W



 605400501
 605400511
 605400579



Tischleuchte · Table lamp
 ↑ 18 cm, Ø 9,5 cm
 excl. 1 x E14, max. 25 W



 595400101
 595400111
 595400179





GARDA

Nickel matt, Stoffschirm · nickel mat, fabric shade ·
 nickel mat, abat-jour tissu · nikkel mat, Stoffen kap · níquel mate, Pantalla de tela ·
 nichel opaco, paralume in tessuto · nichel mat, abajur textil · harjattu teräs, kangas varjostin ·
 nikiel mat, Klosz z materiału

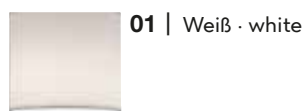

01 | Weiß · white



41 | Taupe · taupe



11 | Grau · grey



79 | goldfarbig · gold



Pendelleuchte · Pendant

↔ 77 x 13,5 cm, ↓ 95 - 150 cm
 excl. 4 x E14, max. 28 W



305400401
 305400411
 305400441
 305400479



Deckenleuchte · Ceiling lamp
↔ 30 x 30 cm, ↓ 15,5 cm
excl. 2 x E27, max. 40 W



603100244

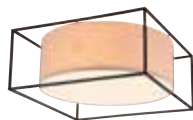

Deckenleuchte · Ceiling lamp
↔ 50 x 50 cm, ↓ 22,5 cm
excl. 3 x E27, max. 40 W



603100344



Deckenleuchte · Ceiling lamp
↔ 40,5 x 34 cm, ↓ 28,5 cm
excl. 3 x E27, max. 40 W



603130317



Tischleuchte · Table lamp
↓ 22 cm, ↔ 14 x 14 cm
excl. 1 x E27, max. 40 W



503100144



ROSS

Metall, schwarz matt, Stoffschilder · metal, black mat, fabric shade ·
 metale, noir mat, abat-jour tissu · metaal, mat zwart, Stoffen kap ·
 metal, estera negra, Pantalla de tela · metallo, nero opaco, paralume in tessuto ·
 metal, negru mat, abajur textil · metalli, mattamusta, kangas varjostin ·
 metal, czarny mat, Klosz z materiału



Pendelleuchte · Pendant
 ↔ 100 x 20 cm, ↓ 150 cm
 excl. 3 x E27, max. 40 W



303100417



Stehleuchte · Floor lamp
 ↓ 153 cm, ↔ 29 x 29 cm
 excl. 3 x E27, max. 40 W



403100317



JULIETA

Metall, Schwarz matt, Samt, innen goldfarbig · metal, black mat, velvet, gold colored inside ·
 métal, noir mat, velours, or · metaal, mat zwart, fluweel, binnenkant goudkleur ·
 metal, estera negra, terciopelo, interior en color dorado · metallo, nero opaco, velluto, interno colore oro ·
 metal, negru mat, catifea, interior culoare aurie · metalli, mattamusta, sametti, sisäosa kullanvärinen ·
 metal, czarny mat, aksamit, wewnątrz złoty



Deckenleuchte · Ceiling lamp
 Ø 30 cm, ↓ 22 cm
 excl. 2 x E14, max. 40 W



619000244

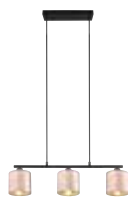

Pendelleuchte · Pendant
 ↔ 66 x 12 cm, ↓ 150 cm
 excl. 3 x E14, max. 40 W



319000344



Tischleuchte · Table lamp
 ↓ 20 cm, Ø 30 cm
 excl. 1 x E27, max. 40 W



519000144



Stehleuchte · Floor lamp
 ↓ 156 cm, Ø 35 cm, ↗ 63 cm
 excl. 1 x E27, max. 40 W



419000144







AGUDO

Metall, Schwarz matt / Coffee · metal, black mat / coffee ·
 métal, noir mat / café · metaal, mat zwart / koffie · metal, estera negra / café · metallo, nero opaco / caffè ·
 metal, negru mat / cafea · metalli, mattamusta / antiikkiteräs · metal, czarny mat / kawa



Deckenleuchte · Ceiling lamp
 Ø 30 cm, ↑ 24,5 cm
 excl. 3 x E27, max. 40 W



619430317

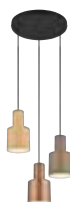

Pendelleuchte · Pendant
 Ø 37 cm, ↑ 150 cm
 excl. 3 x E27, max. 40 W



319430317

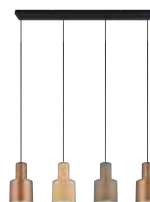

Pendelleuchte · Pendant
 ↔ 87 x 12 cm, ↑ 150 cm
 excl. 4 x E27, max. 40 W



319400417

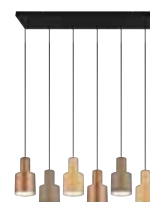

Pendelleuchte · Pendant
 ↔ 85 x 27 cm, ↑ 150 cm
 excl. 6 x E27, max. 40 W



319400617







ROXIE

Metall, Schwarz matt, goldfarbig · metal, black mat, gold ·
 métal, noir mat, or · metaal, mat zwart, goud · metal, estera negra, oro ·
 metallo, nero opaco, oro · metal, negru mat, aur · metalli, mattamusta, kultaa · metal, czarny mat, złota



Pendelleuchte · Pendant
 ↓ 150 cm, Ø 60 cm
 excl. 6 x E14, max. 10 W



311900632



Pendelleuchte · Pendant
 ↓ 150 cm, ↔ 113 x 69 cm
 excl. 7 x E14, max. 10 W



311900732



Tischleuchte · Table lamp
 ↓ 43 cm, ↔ 17 cm, ∠ 25,5 cm
 excl. 1 x E14, max. 10 W



511900132



Stehleuchte · Floor lamp
 ↓ 155 cm, ↔ 43 cm, ∠ 23 cm
 excl. 2 x E14, max. 10 W



411900232

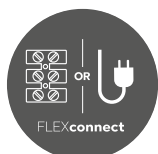

Seite/page 580

ROXIE

Metall, Schwarz matt, goldfarbig · metal, black mat, gold ·
 métal, noir mat, or · metaal, mat zwart, goud · metal, estera negra, oro ·
 metallo, nero opaco, oro · metal, negru mat, aur · metalli, mattamusta, kultaa ·
 metal, czarny mat, złota



Strahler · Spot

↑ 22,7 cm, ↔ 10 cm, ↗ 15,7 cm
 excl. 1 x E14, max. 10 W



811900132



Strahler · Spot

↔ 40 x 13,8 cm, ↓ 22,8 cm
 excl. 2 x E14, max. 10 W



811900232



Strahler · Spot

↔ 60 x 13,8 cm, ↓ 22,8 cm
 excl. 3 x E14, max. 10 W



811900332



Deckenleuchte · Ceiling lamp

Ø 66 cm, ↓ 33 cm
 excl. 6 x E14, max. 10 W



611900632





TAMIL

Metall oder Metall / Holz naturbelassen · metal or metal / wood natural finish ·
 métal ou métal / bois finition naturelle · metaal of metaal / hout natuurlijke afwerking ·
 metal o metal / madera acabado natural · metallo o metallo / di legno finitura naturale ·
 metal sau metal / lemn finisaj natural · metalli tai metalli / puu luonnollinen viimeistely ·
 metal lub metal / drewno naturalne wykończenie



08 | Messing matt · brass mat



67 | Nickel antik · nickel antique

Empfohlen:
 recommended: Filament LED E27, 4,5 W
 470 lm, 2.700 K



987-400



Deckenleuchte · Ceiling lamp
 Ø 50 cm, ↓ 22,5 cm
 excl. 3 x E27, max. 40 W



611100308
 611100367



Pendelleuchte · Pendant
 ↓ 150 cm, Ø 50 cm
 excl. 3 x E27, max. 40 W



311100308
 311100367





Pendelleuchte · Pendant
 Ø 54,5 cm, ↓ 150 cm
 excl. 6 x E27, max. 28 W



306700632
 306700602 | Schwarz · black



Deckenleuchte · Ceiling lamp
 Ø 56,6 cm, ↓ 19,1 cm
 excl. 6 x E27, max. 40 W



606700632



Stehleuchte · Floor lamp
 ↓ 165 cm, Ø 54,5 cm
 excl. 6 x E27, max. 28 W



406700632





CROSS

Metall, Schwarz matt / goldfarbig · metal, black mat / gold ·
 metale, noir mat / or · metaal, mat zwart / goud ·
 metal, estera negra / oro · metallo, nero opaco / oro ·
 metal, negru mat / aur · metalli, musta matto / kultaa ·
 metal, czarny mat / złota

Empfohlen:
 recommended: Filament LED E27, 6 W
 660 lm, 2.700 K



988-679



Pendelleuchte · Pendant
 ↔ 91 x 45 cm, ↓ 150 cm
 excl. 7 x E27, max. 28 W



306700732

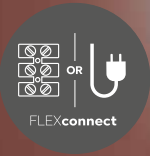

Seite/page 580



DIALLO

Metall, Schwarz matt · metal, black mat ·
metale, noir mat · metaal, mat zwart · metal, estera negra ·
metallo, nero opaco · metal, negru mat · metalli, musta matto ·
metal, czarny mat

Empfohlen:
recommended: Filament LED E27, 7 W
806 lm, 3.000 K



988-600



Wandleuchte · Wall lamp
↓ 15 x 10 cm, ↗ 20 cm
excl. 1 x E27, max. 42 W



208070132



Tischleuchte · Table lamp
↓ 51 cm, ↔ 15 cm, ↗ 23,5 cm
excl. 1 x E27, max. 42 W



508000132



Stehleuchte · Floor lamp
↓ 149 cm, ↔ 23 cm, ↗ 39,3 cm
excl. 1 x E27, max. 42 W



408000132

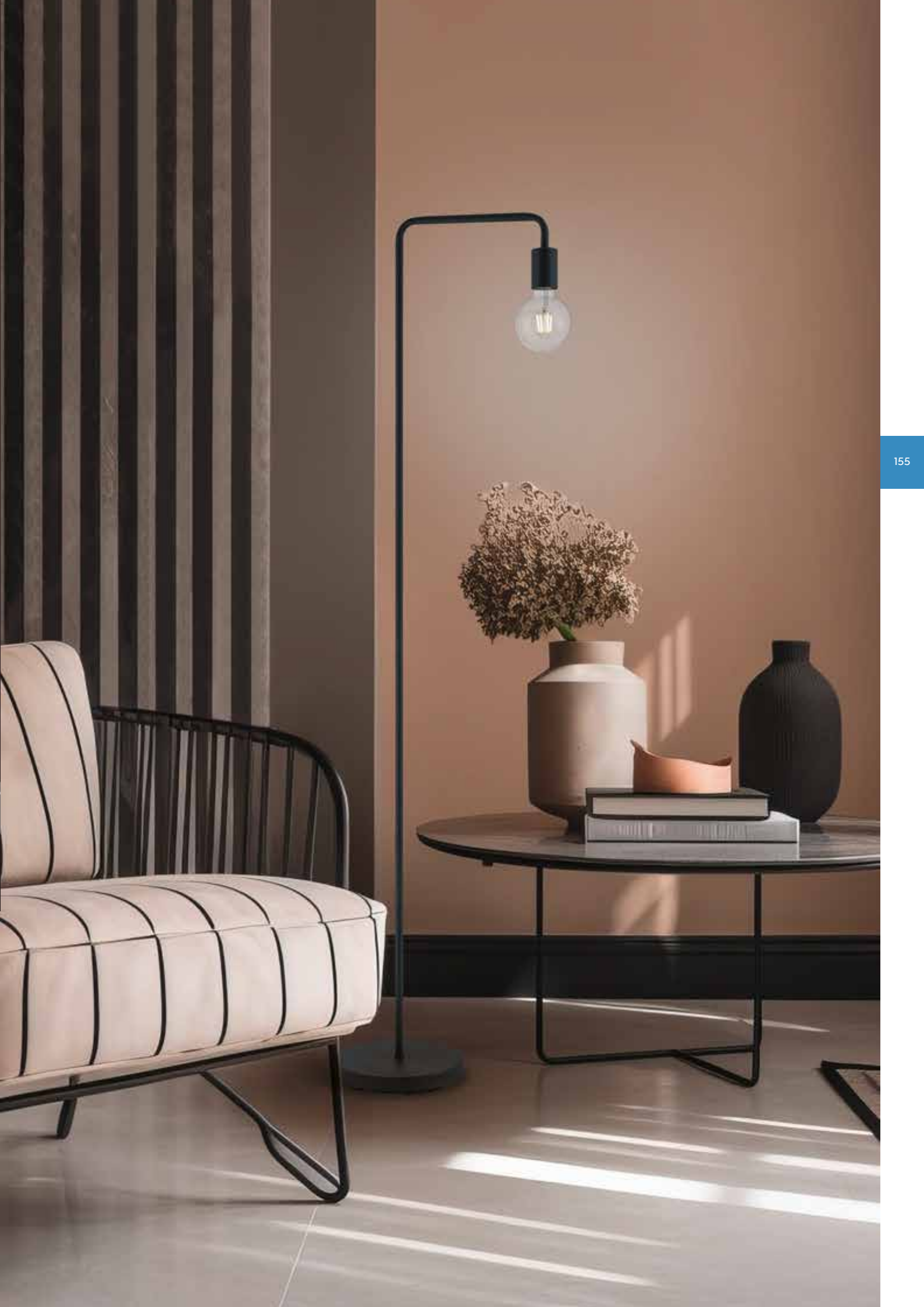



RUSTICA

Metall, rostfarbig, Glas matt · metal, rusty, mat glass ·
 metals, rouille, verre mat · metaal, roestkleur, mat glas ·
 metal, óxido, vidrio mate · metallo, ruggine, vetro sabbaiato ·
 metal, ruginiu, sticla mata · metalli, rustiikki, mattalasi ·
 metal, miedz, szklo matowane

Empfohlen:
 recommended: LED E14, 3,5 W
 320 lm, 3.000 K



983-40



Deckenleuchte · Ceiling lamp
 Ø 55 cm, ↑ 42,5 cm
 excl. 3 x E14, max. 40 W



601000324



Pendelleuchte · Pendant
 ↓ 150 cm, Ø 55 cm
 excl. 3 x E14, max. 40 W



101000324



Pendelleuchte · Pendant
 ↓ 150 cm, Ø 60 cm
 excl. 5 x E14, max. 40 W



101000524





RUSTICA

Metall, rostfarbig, Glas matt · metal, rusty, mat glass ·
 metals, rouille, verre mat · metaal, roestkleur, mat glas ·
 metal, óxido, vidrio mate · metallo, ruggine, vetro sabbiate ·
 metal, ruginiu, sticla mata · metalli, rustiikki, mattalasi ·
 metal, miedź, szkło matowane



Deckenleuchte · Ceiling lamp
 Ø 38 cm, ↑ 16,5 cm
 excl. 2 x E27, max. 60 W



6102021-24



Tischleuchte · Table lamp
 ↓ 50 cm, Ø 31 cm
 excl. 2 x E14, max. 40 W



501000224



Stehleuchte · Floor lamp
 ↑ 180 cm, Ø 33,5 cm
 excl. 2 x E27, max. 60 W



401000224



Stehleuchte · Floor lamp
 ↑ 180 cm, Ø 32,5 cm
 excl. 1 x E27, max. 100 W
 excl. 1 x E14, max. 40 W



4602021-24





Pendelleuchte · Pendant
 Ø 70 cm, † 150 cm
 excl. 3 x E14, max. 40 W



110700328



Pendelleuchte · Pendant
 Ø 70 cm, † 150 cm
 excl. 5 x E14, max. 40 W



110700528



Deckenleuchte · Ceiling lamp
 Ø 61 cm, † 26 cm
 excl. 3 x E14, max. 40 W



600700328



TRADITIO

Metall, Glas alabasterfarbig · metal, alabaster-coloured glass ·
 metale, verre couleur albâtre · metaal, albastkleurig glas ·
 metal, vidrio de color alabastro · metallo, vetro colore alabastro ·
 metal, sticla culoare alabastru · metalli, lasi alabasteri väri ·
 metal, szkło alabaster kolor

Empfohlen:
 recommended: LED E14, 3,5 W
 320 lm, 3.000 K



983-40



Wandleuchte · Wall lamp
 ↔ 12 x 21,5 cm, ↗ 29 cm
 excl. 1 x E14, max. 40 W



200700128



Tischleuchte · Table lamp
 ↓ 32 x 16 cm, ↗ 27 cm
 excl. 1 x E14, max. 40 W



500700128





Natur & Design

Nature & Design

Nature et design

Natuur en design

Naturalidad & Diseño

Natura e design

Natură și design

Luonto ja suunnittelu

Naturalność i dizajn



HARPER

Metall, Schwarz matt, Holz naturbelassen · metal, black mat, wood natural finish ·
 métal, noir mat, bois finition naturelle · metaal, mat zwart, hout natuurlijke afwerking ·
 metal, estera negra, maderacabado natural · metallo, nero opaco, di legno finitura naturale ·
 metal, negru mat, lemn finisaj natural · metalli, mattamusta, puu luonnollinen viimeistely ·
 metal, czarny mat, drewno naturalne wykończenie

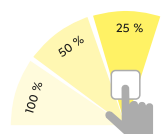

SWITCH DIMMER



Deckenleuchte · Ceiling lamp

↔ 65 x 34,5 cm, ↓ 7,5 cm
 incl. SMD-LED, 30 W
 4.000 lm, 3.000 K



622910332



Deckenleuchte · Ceiling lamp

↔ 115 x 44,5 cm, ↓ 7,5 cm
 incl. SMD-LED, 42 W
 5.700 lm, 3.000 K



622910532



Pendelleuchte · Pendant

↓ 150 cm, ↔ 115 x 44,5 cm
 incl. SMD-LED, 42 W
 5.700 lm, 3.000 K



322910532

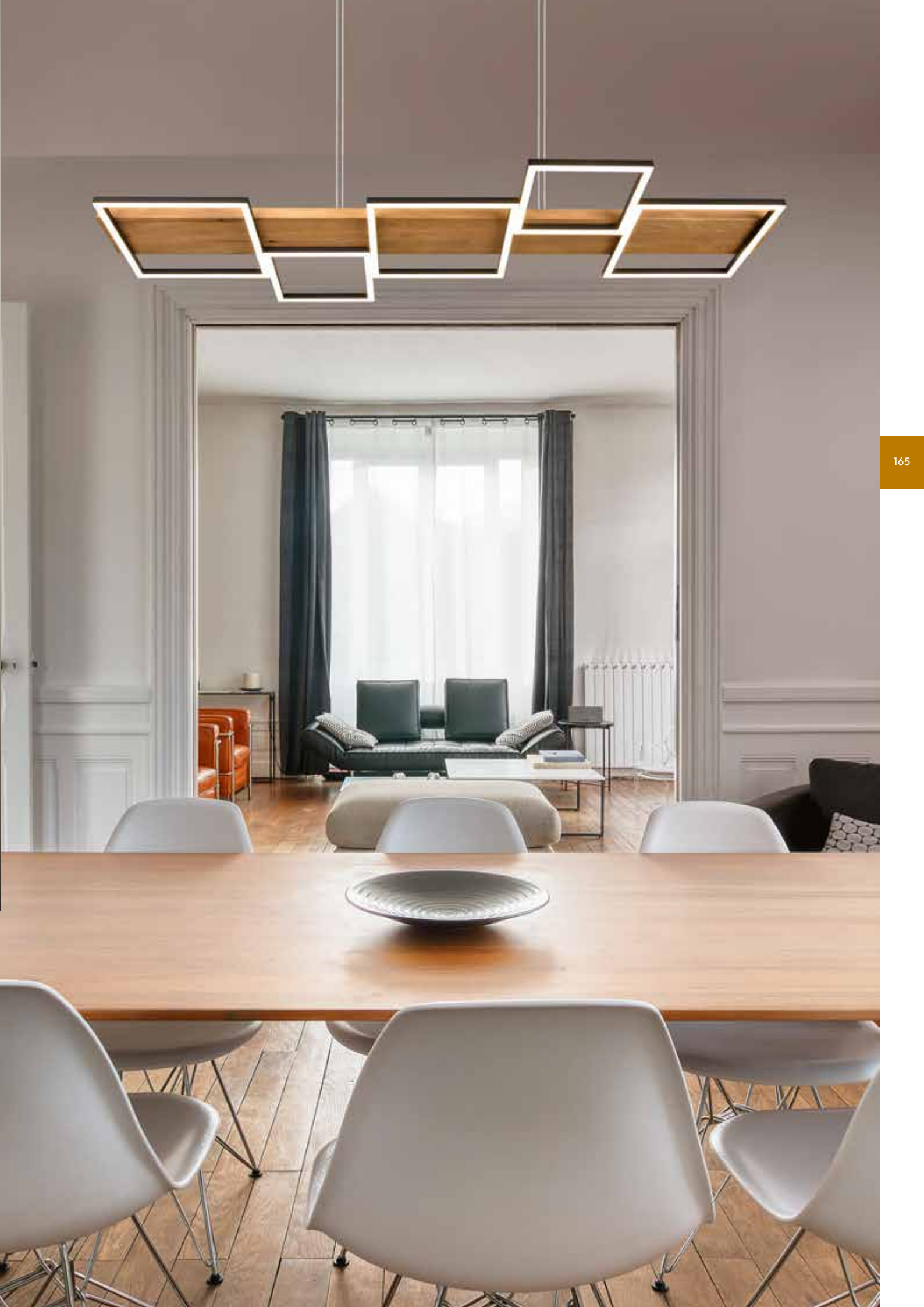



BARCA

Metall, Weiß matt oder Schwarz matt, Holz naturbelassen · metal, white mat or black mat, wood natural finish ·
 métal, blanc mat ou noir mat, bois finition naturelle · metaal, wit mat mat zwart, hout natuurlijke afwerking · metal, estera blanca o estera negra,
 madera acabado natural · metallo, bianco opaco o nero opaco, di legno finitura naturale · metal, alb mat sau negru mat, lemn finisaj natural ·
 metalli, mattavalkoinen tai mattamusta, puu luonnollinen viimeistely · metal, biały mat lub czarny mat, drewno naturalne wykończenie

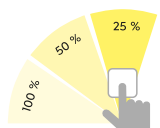

SWITCH DIMMER



Wandleuchte · Wall lamp

↔ 44 x 24 cm, ↑ 8 cm
 incl. SMD-LED, 16 W
 1.800 lm, 3.000 K



241110131
 241110132



Deckenleuchte · Ceiling lamp

↔ 75 x 33 cm, ↑ 10 cm
 incl. SMD-LED, 30 W
 3.500 lm, 3.000 K



641110231
 641110232



Deckenleuchte · Ceiling lamp

↔ 97 x 33 cm, ↑ 10 cm
 incl. SMD-LED, 40 W
 4.700 lm, 3.000 K



641110331
 641110332





RAMA

Metall, Schwarz matt, Holz naturbelassen · metal, black mat, wood natural finish ·
 métal, noir mat, bois finition naturelle · metaal, mat zwart, hout natuurlijke afwerking ·
 metal, estera negra, maderacabado natural · metallo, nero opaco, di legno finitura naturale ·
 metal, negru mat, lemn finisaj natural · metalli, mattamusta, puu luonnollinen viimeistely ·
 metal, czarny mat, drewno naturalne wykończenie

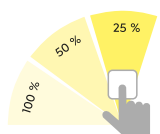

SWITCH DIMMER



Deckenleuchte · Ceiling lamp
 ↔ 67,5 x 32,5 cm, ↓ 12,5 cm
 incl. SMD-LED, 32 W
 3.800 lm, 3.000 K



643210332



Deckenleuchte · Ceiling lamp
 ↔ 72 x 32,5 cm, ↓ 12,5 cm
 incl. SMD-LED, 36 W
 4.200 lm, 3.000 K



643210432





32 | Schwarz matt/Weiß ·
black mat/white

87 | titanfarbig/Schwarz ·
titan/black



Deckenleuchte · Ceiling lamp
↔ 53,5 x 34,5 cm, ↑ 8 cm
incl. SMD-LED, 26 W
3.000 lm, 3.000 K



643810232
643810287



Deckenleuchte · Ceiling lamp
↔ 80 x 34,5 cm, ↑ 8 cm
incl. SMD-LED, 33 W
3.800 lm, 3.000 K



643810332
643810387



Deckenleuchte · Ceiling lamp
↔ 100 x 34,5 cm, ↑ 8 cm
incl. SMD-LED, 44 W
5.100 lm, 3.000 K



643810432
643810487



MEDERA

Metall, Holz · metal, wood ·
 metale, bois · metaal, hout · metal, madera · metallo, di legno ·
 metal, lemn · metalli, puu · metal, drewno · metal, tahta

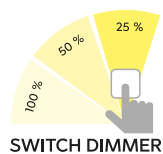



KERALA

Metall, Schwarz matt, Holz naturbelassen · metal, black mat, wood natural finish ·
 métal, noir mat, bois finition naturelle · metaal, mat zwart, hout natuurlijke afwerking ·
 metal, estera negra, madera acabado natural · metallo, nero opaco, di legno finitura naturale ·
 metal, negru mat, lemn finisaj natural · metalli, mattamusta, puu luonnollinen viimeistely ·
 metal, czarny mat, drewno naturalne wykończenie

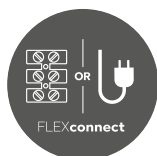

Seite/page 580



Wandleuchte · Wall lamp

↓ 7 cm, ↔ 30 cm, ↗ 13 cm
 incl. SMD-LED, 9 W
 1.100 lm, 3.000 K



241670132



Deckenleuchte · Ceiling lamp

↔ 83 x 14,5 cm, ↓ 11,5 cm
 incl. 2 x SMD-LED, 12,5 W
 2 x 1.500 lm, 3.000 K



641610232



Pendelleuchte · Pendant
 ↓ 150 cm, ↔ 90 x 8,5 cm
 incl. SMD-LED, 25 W
 3.000 lm, 3.000 K



341610132



Tischleuchte · Table lamp
 ↓ 50 cm, ↔ 11 x 14 cm
 incl. SMD-LED, 8 W
 950 lm, 3.000 K



541610132



Stehleuchte · Floor lamp
 ↓ 120 cm, ↔ 19 x 13 cm
 incl. SMD-LED, 16 W
 1.950 lm, 3.000 K



441610132





2.700 K

6.000 K

BELLARI

Holz, Metall Schwarz matt · wood, metal black mat ·
 bois, metale noir mat · hout, metaal mat zwart · madera, metal estera negra ·
 di legno, metallo nero opaco · lemn, metal negru mat · puu, metalli mattamusta ·
 drewno, metal czarny mat



Deckenleuchte · Ceiling lamp
 ↔ 180 x 10 cm, ↑ 13,5 cm
 incl. SMD-LED, 36 W
 4.200 lm, 2.700 - 6.000 K



626410530



Stehleuchte · Floor lamp
 ↓ 115 cm, ↔ 22 x 22 cm
 incl. SMD-LED, 20 W
 2.300 lm, 3.000 K



426410130

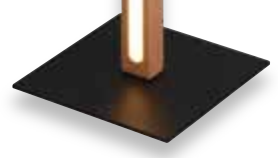

4 fach TOUCH ·
 4 level Touch function

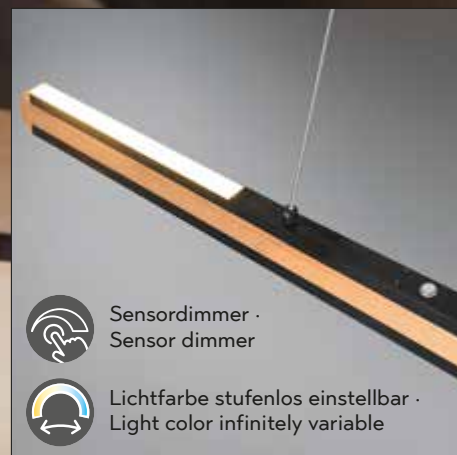

DEACON

Metall, Schwarz matt, Holz · metal, black mat, wood ·
 metale, noir mat, bois · metaal, mat zwart, hout · metal, estera negra, madera ·
 metallo, nero opaco, di legno · metal, negru mat, lemn · metalli, mattamusta, puu ·
 metal, czarny mat, drewno



Deckenleuchte · Ceiling lamp
 Ø 50 cm, ↓ 7 cm
 incl. SMD-LED, 37 W
 4.400 lm, 3.000 K



626610232



Pendelleuchte · Pendant
 ↔ 110 x 6,5 cm, ↓ 150 cm
 incl. SMD-LED, 42 W
 5.000 lm, 2.700 - 6.000 K



326610232



ARUNI

Metall, Weiß matt oder Schwarz matt, Holz naturbelassen · metal, white mat or black mat, wood natural finish ·
 métal, blanc mat ou noir mat, bois finition naturelle · metaal, wit mat mat zwart, hout natuurlijke afwerking · metal, estera blanca o estera negra,
 madera acabado natural · metallo, bianco opaco o nero opaco, di legno finitura naturale · metal, alb mat sau negru mat, lemn finisaj natural ·
 metalli, mattavalkoinen tai mattamusta, puu luonnollinen viimeistely · metal, biały mat lub czarny mat, drewno naturalne wykończenie



Strahler · Spot
 Ø 11 cm, ↗ 15 cm
 excl. 1 x GU10, max. 5 W



801170131
 801170132



Strahler · Spot
 ↔ 28 x 9 cm, ↑ 15 cm
 excl. 2 x GU10, max. 5 W



801100231
 801100232



Strahler · Spot
 ↔ 48 x 9 cm, ↑ 15 cm
 excl. 3 x GU10, max. 5 W



801100331
 801100332

Empfohlen:
 recommended: LED GU10, 4,5 W
 345 lm, 3.000 K



956-55





TAILOR

Metall, Nickel antik, Holz · metal, nickel antique, wood ·
 metale, nickel antique, bois · metaal, antiek nikkel, hout · metal, níquel antiguo, madera ·
 metallo, nickel anticato, di legno · metal, nichel antic, lemn · metalli, antiikkiteräs, puu ·
 metal, aikiel antyczny, drewno



Deckenleuchte · Ceiling lamp
 ↔ 115 x 20 cm, ↑ 15,7 cm
 excl. 4 x E27, max. 10 W



614300430



Pendelleuchte · Pendant
 ↔ 115 x 20 cm, ↑ 150 cm
 excl. 4 x E27, max. 10 W



314300430



Tischleuchte · Table lamp
 ↓ 52,5 cm, ↔ 22 x 15 cm
 excl. 2 x E27, max. 10 W



514300230



Stehleuchte · Floor lamp
 ↓ 142,5 cm, ↔ 30 x 22 cm
 excl. 5 x E27, max. 10 W



414300530





BRAD

Nickel antik, Holz · nickel antique, wood ·
 nickel antique, bois · antiek nikkel, hout · níquel antiguo, madera ·
 nickel anticato, di legno · nichel antic , lemn · antiikkiteräs, puu ·
 aikiel antyczny, drewno · antik nikel, tahta

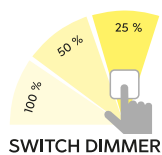

Wandleuchte · Wall lamp
 ↓ 11 x 11 cm, ↗ 11 cm
 incl. OSRAM-LED, 4,3 W
 430 lm, 3.000 K



223710130



Wandleuchte · Wall lamp
 ↓ 11 x 37 cm, ↗ 11 cm
 incl. SMD-LED, 13,5 W
 1.500 lm, 3.000 K



223790130



Deckenleuchte · Ceiling lamp
 ↔ 100 x 20 cm, ↓ 16,7 cm
 incl. SMD-LED, 27 W
 3.400 lm, 3.000 K



623710130



Pendelleuchte · Pendant
 ↔ 100 x 20 cm, ↓ 150 cm
 incl. SMD-LED, 27 W
 3.400 lm, 3.000 K



323710130





Seite/page 580

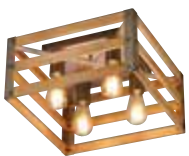

Deckenleuchte · Ceiling lamp
 ↔ 40 x 40 cm, ↓ 20 cm
 excl. 4 x E27, max. 28 W



605500467



Wandleuchte · Wall lamp
 ↓ 20 cm, ↔ 15 cm, ↗ 11 cm
 excl. 1 x E27, max. 28 W



205570167



Wandleuchte · Wall lamp
 ↓ 20 cm, ↔ 35 cm, ↗ 11 cm
 excl. 2 x E27, max. 28 W



205570267



KHAN

Nickel antik, Holz · nickel antique, wood ·
 nickel antique, bois · antiek nikkel, hout · níquel antiguo, madera ·
 nickel anticato, di legno · nichel antic , lemn · antiikkiteräs, puu ·
 aikiel antyczny, drewno · antik nikel, tahta

Empfohlen:
 recommended: Filament LED E27, 6 W
 600 lm, 2.700 K



987-679



Stehleuchte · Floor lamp
 ↓ 153 cm, ↔ 25 x 25 cm
 excl. 3 x E27, max. 10 W



405500367



Pendelleuchte · Pendant
 ↔ 100 x 15 cm, ↓ 150 cm
 excl. 4 x E27, max. 28 W



305500467



HEDDA

Metall, Schwarz matt, Sisal · metal, black mat, Sisal ·
 metale, noir mat, Sisal · metaal, mat zwart, Sisal · metal, estera negra, Sisal ·
 metallo, nero opaco, Sisal · metal, negru mat, Sisal · metalli, mattamusta, Sisal ·
 metal, czarny mat, Sisol



Deckenleuchte · Ceiling lamp
 Ø 52 cm, ↑ 28 cm
 excl. 2 x E27, max. 40 W



612300236



Pendelleuchte · Pendant
 Ø 52 cm, ↑ 150 cm
 excl. 1 x E27, max. 40 W



312300136



Stehleuchte · Floor lamp
 ↑ 150 cm, Ø 52 cm
 excl. 1 x E27, max. 40 W



402300136

Empfohlen:
 recommended: Filament LED E27, 4 W
 470 lm, 2.700 K



987-400





INGA

Rattangeflecht, Metall, Schwarz matt · rattan meshwork, metal, black mat ·
 maillage rotin, métal, noir mat · rotan vlechtwerk, metaal, mat zwart · malla de Rattan, metal, estera negra ·
 reticolo rattan, metallo, nero opaco · impletitura ratan, metal, negru mat · rottinki, metalli, mattamusta · rattan, metal, czarny mat



Deckenleuchte · Ceiling lamp
 Ø 50 cm, ↓ 30 cm
 excl. 3 x E27, max. 40 W



612200336



Pendelleuchte · Pendant
 Ø 29 cm, ↓ 150 cm
 excl. 1 x E27, max. 40 W



312200136



Pendelleuchte · Pendant
 Ø 50 cm, ↓ 150 cm
 excl. 3 x E27, max. 40 W



312200336



Tischleuchte · Table lamp
 ↓ 30 cm, Ø 16,5 cm
 excl. 1 x E27, max. 40 W



512200136



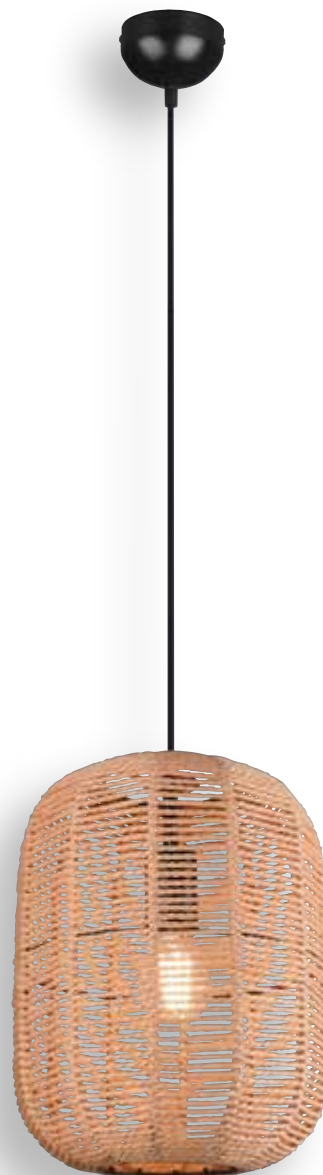

RUNA

Metall, Schwarz matt, Sisal · metal, black mat, Sisal ·
 metale, noir mat, Sisal · metaal, mat zwart, Sisal · metal, estera negra, Sisal · metallo, nero opaco, Sisal ·
 metal, negru mat, Sisal · metalli, mattamusta, Sisal · metal, czarny mat, Sisal



Wandleuchte · Wall lamp
 ↓ 27,5 cm, ↔ 23 cm, ↗ 15 cm
 excl. 1 x E27, max. 40 W



203000132



Pendelleuchte · Pendant
 Ø 25 cm, ↓ 150 cm
 excl. 1 x E27, max. 40 W



303000132



Pendelleuchte · Pendant
 Ø 35 cm, ↓ 150 cm
 excl. 1 x E27, max. 40 W



303090132



Stehleuchte · Floor lamp
 ↓ 150 cm, Ø 35 cm
 excl. 1 x E27, max. 40 W



403000132





COLINO

Metall, Holz · metal, wood ·
metale, bois · metaal, hout · metal, madera · metallo, di legno ·
metal, lemn · metalli, puu · metal, drewno · metal, tahta

Empfohlen:
recommended: Filament LED E27, 4 W
470 lm, 2.700 K



987-400



32 | Schwarz matt · black mat



42 | naturbelassen · natural finish



Deckenleuchte · Ceiling lamp
Ø 40 cm, ↑ 26 cm
excl. 2 x E27, max. 40 W



615900232
615900242

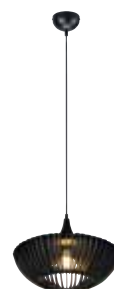

Pendelleuchte · Pendant
Ø 40 cm, ↑ 150 cm,
excl. 1 x E27, max. 40 W



315900132
315900142





KORBA

Holz, Stoffschirm · wood, fabric shade ·
 bois, abat-jour tissu · hout, Stoffen kap ·
 madera, Pantalla de tela · di legno, paralume in tessuto ·
 lemn, abajur textil · puu, kangas varjostin ·
 drewno, Klosz z materiału · tahta, Kumaş şapka



Stehleuchte · Floor lamp
 † 162 cm, Ø 40 cm
 excl. 1 x E27, max. 60 W



401200101

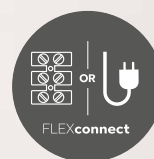

Seite/page 580

NILAM

Holz, Stoffschirm · wood, fabric shade ·
bois, abat-jour tissu · hout, Stoffen kap ·
madera, Pantalla de tela · di legno, paralume
in tessuto · lemn, abajur textil · puu, kangas
varjostin · drewno, Klosz z materiału ·
tahta, Kumaş şapka



Getrennt schaltbar ·
Separately switchable



Flexibel ·
Flexible



Wandleuchte · Wall lamp
↓ 30 x 25 cm, ↗ 38 cm
incl. SMD-LED, 3,1 W
310 lm, 3.000 K
excl. 1 x E27, max. 28 W



212870236



Wandleuchte · Wall lamp
↓ 30 x 18 cm, ↗ 38 cm
incl. SMD-LED, 3,1 W
310 lm, 3.000 K
excl. 1 x E27, max. 28 W



212879236



ELMAU

Holz, Stoffschirm · wood, fabric shade ·
 bois, abat-jour tissu · hout, Stoffen kap · madera, Pantalla de tela ·
 di legno, paralume in tessuto · lemn, abajur textil · puu, kangas varjostin · drewno, Klosz z materiału



Deckenleuchte · Ceiling lamp
 Ø 35 cm, ↑ 36,5 cm
 excl. 1 x E27, max. 60 W



602100130



Pendelleuchte · Pendant
 Ø 35 cm, ↑ 150 cm
 excl. 1 x E27, max. 60 W



302100130



Pendelleuchte · Pendant
 ↔ 100 x 20 cm, ↑ 150 cm
 excl. 4 x E27, max. 60 W



302100430



Tischleuchte · Table lamp
 ↑ 40 cm, Ø 18 cm
 excl. 1 x E14, max. 40 W



502100130





SAESONS

Holz naturbelassen, Stoff · wood natural finish, fabric ·
 bois finition naturelle, tissu · hout natuurlijke afwerking, textiel ·
 madera acabado natural, tela · di legno finitura naturale, tessuto ·
 lemn finisaj natural, textil · puu luonnollinen viimeistely, tekstiili ·
 drewno naturalne wykończenie, tkanina



01 | Weiß · white



02 | Schwarz · black



Deckenleuchte · Ceiling lamp
 Ø 30 cm, ↑ 22 cm
 excl. 2 x E14, max. 40 W



611500201
 611500202



Deckenleuchte · Ceiling lamp
 Ø 50 cm, ↑ 22 cm
 excl. 3 x E27, max. 40 W



611500301
 611500302



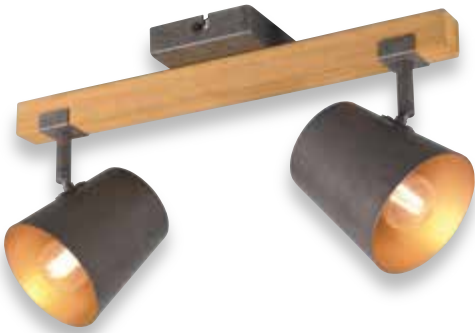

Deckenleuchte · Ceiling lamp
 ↔ 42,5 x 14,5 cm, ↓ 23,2 cm
 excl. 2 x E14, max. 25 W



801900267



Deckenleuchte · Ceiling lamp
 ↔ 54 x 14,5 cm, ↓ 23 cm
 excl. 3 x E14, max. 25 W



801900367

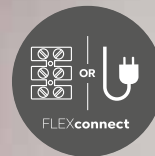

Seite/page 580



Wandleuchte · Wall lamp
 ↔ 11 x 11 cm, ↓ 23,2 cm
 excl. 1 x E14, max. 25 W



801900167



Deckenleuchte · Ceiling lamp
 ↔ 39 x 39 cm, ↓ 19,8 cm
 excl. 4 x E14, max. 25 W



601900467



Stehleuchte · Floor lamp
 ↓ 150 cm, ↔ 25 x 25 cm
 excl. 3 x E14, max. 25 W



401900367





BELL

Metall, Nickel antik, innen goldfarbig, Holz · metal, nickel antique, gold colored inside, wood ·
 metale, nickel antique, Or, bois · metaal, antiek nikkel, Binnenkant goudkleur, hout ·
 metal, níquel antiguo, Interior en color dorado, madera · metallo, nickel anticato,
 interno colore oro, di legno · metal, nichel antic, interior culoare aurie, lemn ·
 metalli, antiikkiteräs, sisäosa kullanvärinen, puu · metal, aikiel antyczny, wewnątrz złoty, drewno

Empfohlen:
 recommended: Filament LED E14, 4 W
 470 lm, 3.000 K



983-400

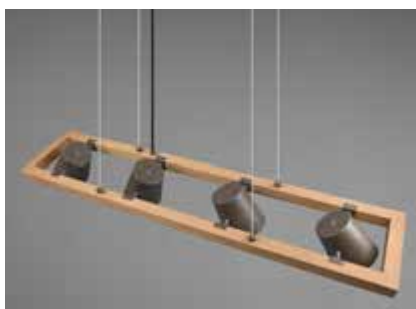

Pendelleuchte · Pendant
 ↔ 100 x 21 cm, ↓ 150 cm
 excl. 4 x E14, max. 25 W



301900467



DELHI

Metall, Nickel antik, Holz · metal, nickel antique, wood ·
 metale, nickel antique, bois · metaal, antiek nikkel, hout · metal, níquel antiguo, madera ·
 metallo, nickel anticato, di legno · metal, nichel antic, lemn ·
 metalli, antiikkiteräs, puu · metal, aikiel antyczny, drewno

Empfohlen:
 recommended: Filament LED E27, 4 W
 470 lm, 2.700 K



987-400



Pendelleuchte · Pendant
 Ø 45 cm, ↓ 150 cm
 excl. 1 x E27, max. 60 W



303400167



Pendelleuchte · Pendant
 ↔ 107,5 cm, ↓ max. 215 cm, Ø 25,5 cm
 excl. 3 x E27, max. 42 W



303400367





DELHI

Metall, Nickel antik, Holz · metal, nickel antique, wood ·
 metale, nickel antique, bois · metaal, antiek nikkel, hout · metal, níquel antiguo, madera ·
 metallo, nickel anticato, di legno · metal, nichel antic, lemn · metalli, antiikkiteräs, puu ·
 metal, aikiel antyczny, drewno



Wandleuchte · Wall lamp
 Ø 11,6 cm, ↗ 20,5 cm
 excl. 1 x E14, max. 40 W



803400167



Deckenleuchte · Ceiling lamp
 ↔ 33 x 11,6 cm, ↓ 20,5 cm
 excl. 2 x E14, max. 40 W



803400267



Deckenleuchte · Ceiling lamp
 ↔ 58 x 11,6 cm, ↓ 20,5 cm
 excl. 3 x E14, max. 40 W



803400367



Stehleuchte · Floor lamp
 ↑ 158 cm, ↔ 66 cm, Ø 40 cm
 excl. 1 x E27, max. 60 W



403400167





AGRA

Metall, Schwarz matt, Holz · metal, black mat, wood ·
 metale, noir mat, bois · metaal, mat zwart, hout · metal, estera negra, madera ·
 metallo, nero opaco, di legno · metal, negru mat, lemn · metalli, mattamusta, puu ·
 metal, czarny mat, drewno

Empfohlen:
 recommended: Filament LED E27, 4 W
 470 lm, 2.700 K



987-400



Pendelleuchte · Pendant
 ↔ 60 x 8,5 cm, ↓ 150 cm
 excl. 3 x E27, max. 10 W



313800332



Pendelleuchte · Pendant
 ↔ 100 x 8,5 cm, ↓ 150 cm
 excl. 5 x E27, max. 10 W



313800532



RODRIGO

Metall, Nickel antik, innen goldfarbig, Holz · metal, nickel antique, gold colored inside, wood ·
 metale, nickel antique, Or, bois · metaal, antiek nikkel, Binnenkant goudkleur, hout ·
 metal, níquel antiguo, Interior en color dorado, madera · metallo, nickel anticato, interno colore oro, di legno ·
 metal, nichel antic, interior culoare aurie, lemn · metalli, antiikkiteräs, sisäosa kullanvärinen, puu ·
 metal, aikiel antyczny, wewnątrz złoty, drewno



Stehleuchte · Floor lamp
 ↑ 165 cm, ↔ 26 cm, ↗ 41 cm
 excl. 1 x E27, max. 60 W



402690167



HARRIS

Metall, Schwarz matt, innen goldfarbig, Holz · metal, black mat, gold colored inside, wood ·
 metale, noir mat, Or, bois · metaal, mat zwart, Binnenkant goudkleur, hout ·
 metal, estera negra, Interior en color dorado, madera · metallo, nero opaco, interno colore oro, di legno ·
 metal, negru mat, interior culoare aurie, lemn · metalli, mattamusta, sisäosa kullanvärinen, puu ·
 metal, czarny mat, wewnątrz złoty, drewno



Pendelleuchte · Pendant
 ↓ 150 cm, Ø 26 cm
 excl. 1 x E27, max. 60 W



312700132



Pendelleuchte · Pendant
 ↓ 150 cm, ↔ 87 cm, Ø 18 cm
 excl. 4 x E27, max. 40 W



312700432



Stehleuchte · Floor lamp
 ↓ 156 cm, ↗ 75 cm, Ø 26 cm
 excl. 1 x E27, max. 60 W



412700132





Wandleuchte · Wall lamp

↔ 9 x 13,7 cm, ↑ 19,5 cm
excl. 1 x E14, max. 15 W



804370132



Deckenleuchte · Ceiling lamp

↔ 26 x 9 cm, ↑ 19,5 cm
excl. 2 x E14, max. 15 W



804370232



Deckenleuchte · Ceiling lamp

↔ 44 x 9 cm, ↑ 19,5 cm
excl. 3 x E14, max. 40 W



804300332



Deckenleuchte · Ceiling lamp

↔ 22 x 22 cm, ↑ 19,5 cm
excl. 4 x E14, max. 40 W



804300432



Pendelleuchte · Pendant

Ø 10 cm, ↑ 150 cm
excl. 1 x E27, max. 40 W



304300132



Pendelleuchte · Pendant

↔ 65 x 9 cm, ↑ 150 cm
excl. 4 x E27, max. 40 W



304300432



TOSH

Metall, Schwarz matt, Holz · metal, black mat, wood ·
 metale, noir mat, bois · metaal, mat zwart, hout · metal, estera negra, madera ·
 metallo, nero opaco, di legno · metal, negru mat, lemn · metalli, mattamusta, puu ·
 metal, czarny mat, drewno

Empfohlen:
 recommended: Filament LED E14,
 4 W,
 470 lm, 3.000 K



983-400



Pendelleuchte · Pendant
 Ø 28 cm, ↑ 150 cm
 excl. 3 x E27, max. 40 W



304330332



Stehleuchte · Floor lamp
 ↑ 150 cm, Ø 23 cm
 excl. 3 x E14, max. 15 W



404300332



Tischleuchte · Table lamp
 ↑ 40 cm, ↔ 15 x 18 cm
 excl. 1 x E14, max. 15 W



504300132



Empfohlen:
recommended: Filament LED E27, 8 W
806 lm, 2.700 K



987-6810

MADRAS

silberfarbig antik, Holz · antique silver, wood ·
argent antique, bois · antiek zilver, hout · plateado antiguo, madera · argento anticato, di legno ·
argint antic, lemn · antiikkihopea, puu · antyczne srebro, drewno · gümüş antika, tahta



Wandleuchte · Wall lamp
↓ 23 x 14 cm, ↗ 14 x 17 cm
excl. 1 x E27, max. 28 W



805300188



Deckenleuchte · Ceiling lamp
↔ 30 x 14 cm, ↓ 28 cm
excl. 2 x E27, max. 28 W



805300288



Deckenleuchte · Ceiling lamp
↔ 60,5 x 14 cm, ↓ 28 cm
excl. 3 x E27, max. 28 W



805300388



Deckenleuchte · Ceiling lamp
↔ 80 x 14 cm, ↓ 28 cm
excl. 4 x E27, max. 28 W



805300488



PLANT

Nickel antik, Sisal · nickel antique, Sisal ·
 nickel antique, Sisal · antiek nikkel, Sisal ·
 níquel antiguo, Sisal · nickel anticato, Sisal ·
 nichel antic, Sisal · antiikkiteräs, Sisal ·
 aikiel antyczny, Sizal

Deko-Pflanze nicht enthalten! · Decoration not included! ·
 Décoration non incluse! · Decoratie niet inbegrepen! ·
 Decoración no incluida. · Decorazione non inclusa! ·
 Decorația nu este inclusă! · Koristus ei sisälly! ·
 Nie zawiera dekoracji!

Empfohlen:
 recommended: Filament LED E27, 4 W
 470 lm, 2.700 K



987-400



92945



Pendelleuchte · Pendant
 ↔ 115 x 22 cm, ↓ 150 cm
 excl. 3 x E27, max. 40 W



301000367

JUDITH

Glas klar · clear glass ·
verre claire · helder glas ·
vidrio claro · vetro chiaro ·
sticla transparentă · kirkas lasi ·
przezroczyste szkło



Pendelleuchte · Pendant

Ø 24,5 cm, ↑ 150 cm
excl. 1 x E27, max. 60 W



302900102

Empfohlen:

recommended: Filament LED E27, 6 W
420 lm, 2.700 K



987-679



ROPE

Metall, Altmessing · metal, old brass ·
metale, laiton fumé · metaal, oud brons · metal, bronce
viejo · metallo, ottone invecchiato · metal, bronz antic ·
metalli, antiikkimessinki · metal, patyna

Empfohlen:

recommended: Filament LED E27, 7 W
806 lm, 3.000 K



988-600

Filament LED E27, 6 W
660 lm, 2.700 K



988-679



Pendelleuchte · Pendant

Ø 12 cm, ↑ 150 cm
excl. 1 x E27, max. 60 W



310100104



Pendelleuchte · Pendant

Ø 12 cm, ↑ 150 cm
excl. 2 x E27, max. 60 W



310100204



BOOLAN

Holz · wood ·
 bois · hout · madera · di legno ·
 lemn · puu · drewno

Empfohlen:
 recommended: Filament LED E27, 7 W
 806 lm, 3.000 K



988-600



26 | Braun · brown



30 | holzfarbig hell · light colored wood

Pendelleuchte · Pendant
 Ø 50 cm, ↓ 150 cm
 excl. 1 x E27, max. 60 W



305900126
 305900130



Pendelleuchten & Kronen

Pendants & chandeliers

Lustres & suspensions

Hanglampen & kroonluchters

Colgantes y Lámparas

Lampadari e sospensioni

Lustre si pendule

Riippu- & kruunu

Wiszące i żyrandole



05 | Aluminium gebürstet ·
brushed aluminium



32 | Schwarz matt · black mat



65 | Coffee · coffee

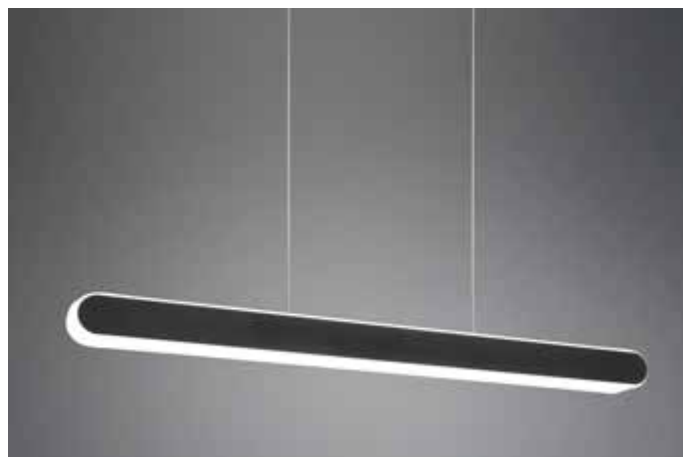

Pendelleuchte · Pendant
↔ 82,5 - 130 cm, ↓ 150 cm
incl. SMD-LED, 48 W
5.800 lm, 2.700 - 6.500 K



343310305
343310332
343310365



HELIOS

Metall · metal ·
metale · metaal · metal · metallo · metal · metalli · metal



Lichtfarbe stufenlos einstellbar ·
Light color infinitely variable



4 fach TOUCH ·
4 level Touch function

Ausziehbar · Extendible · extensible · Verlengbaar ·
Extensible · Estensibile · extensibil · Jatkettava · Rozsuwalny

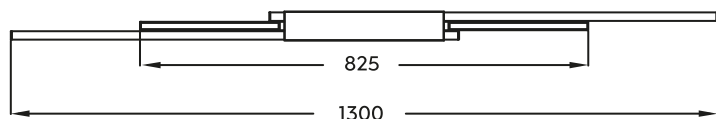



Pendelleuchte · Pendant

↔ 95 - 150 cm, ↓ 95 - 150 cm
 incl. SMD-LED, 45 W, 5.300 lm
 incl. 2 x SMD-LED, 6 W, 2 x 500 lm
 2.700 - 5.000 K



375310502
 375310505
 375310507
 375310508
 375310532





-  **02** | Schwarz / Messing matt · black / brass mat
-  **05** | Aluminium gebürstet · brushed aluminium
-  **07** | Nickel matt · nickel matt
-  **08** | Messing matt · brass matt
-  **32** | Schwarz matt · black matt



TRAJAN

Metall · metal ·
metale · metaal · metal · metallo · metal · metalli · metal

 Lichtfarbe stufenlos einstellbar ·
Light color infinitely variable

 4 fach TOUCH ·
4 level Touch function

Ausziehbar · Extendible · extensible · Verlengbaar ·
Extensible · Estensibile · extensibil · Jatkettava · Rozsuwalny

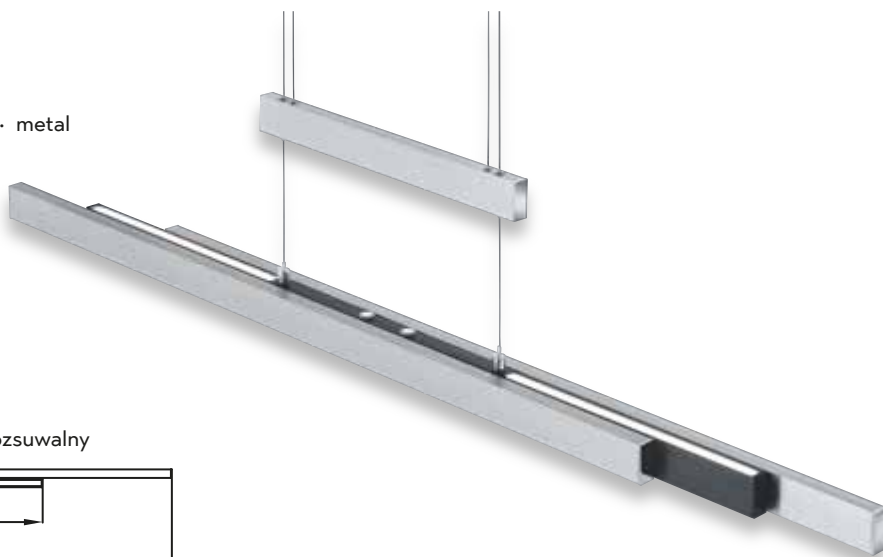
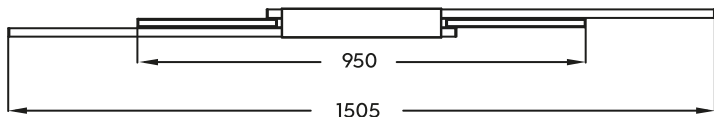



LACAL

Nickel matt oder goldfarbig · nickel mat or gold ·
 nickel mat ou or · nikkell mat of goud · níquel mate o oro ·
 nichel opaco o oro · nichel mat sau aur · harjattu teräs tai kultaa · nikiel mat lub złota

Gibt Licht nach oben und unten · up and down lighting ·
 point lumineux en haut et en bas · lichtpunt boven en onder · luz de arriba y abajo ·
 luce su e giù · sus și în jos lumina · ylös ja alas valoa · w górę iw dół światło



Lichtfarbe einstellbar ·
 Adjustable light color



4 fach TOUCH ·
 4 level Touch function

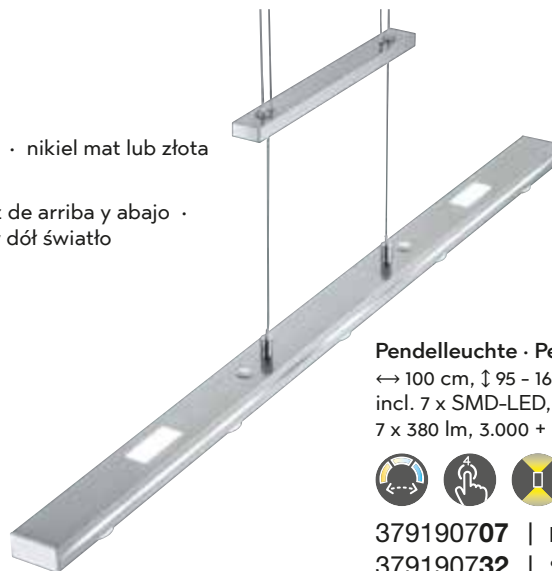

Pendelleuchte · Pendant

↔ 100 cm, ↑ 95 - 160 cm
 incl. 7 x SMD-LED, 4 W
 7 x 380 lm, 3.000 + 5.000 K



379190707 | Nickel matt · nickel mat
 379190732 | Schwarz matt · black mat

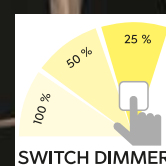

BELFAST

Metall, Nickel matt oder Schwarz matt · metal, nickel mat or black mat ·
 metale, nickel mat ou noir mat · metaal, nikkel mat of mat zwart ·
 metal, níquel mate o estera negra · metallo, nichel opaco o nero opaco ·
 metal, nichel mat sau negru mat · metalli, harjattu teräs tai mattamusta ·
 metal, nikiel mat lub czarny mat

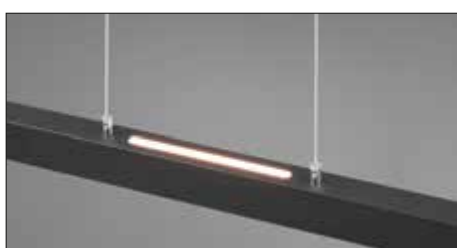

Gibt Licht nach oben und unten · up and down lighting ·
 point lumineux en haut et en bas · lichtpunt boven en onder · luz de arriba y abajo ·
 luce su e giù · sus și în jos lumina · ylös ja alas valoa · w górę i w dół światło

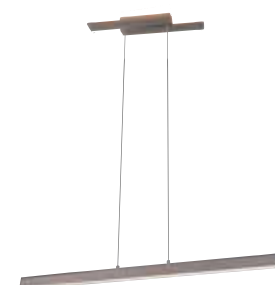

Pendelleuchte · Pendant
 ↔ 115,5 x 14,2 cm, ↓ 150 cm
 incl. SMD-LED, 45 W
 5.300 lm, 3.000 K



375510407 | Nickel matt · nickel mat
 375510432 | Schwarz matt · black mat



MERTON

Nickel matt oder Messing matt, Glas Weiß · nickel mat or brass mat, glass white ·
 nickel mat ou laiton mat, verre blanc · nikkell mat of messing mat, glas wit · níquel mate o bronze mate, vidrio blanco ·
 nichel opaco o ottone satinato, vetro bianco · nichel mat sau bronz mat, sticla alb ·
 afstandsbediening tai geïntegreerde dimmer, lasi schakelaar · nikiel mat lub mosiądz mat, szkło biały



Innovative Höhenverstellung ohne Gegengewicht ·
 Innovative height adjustment without counterweight ·
 Nouveau! Réglage de la hauteur sans contrepoids ·
 Innovatieve hoogterstelling zonder contragewicht ·
 Innovador sistema de ajuste de altura sin necesidad de
 contrapeso · Regolazione innovativa dell'altezza senza
 contrappeso · Ajustare inovativa a înaltimei fara
 contragreutate · Innovatiivinen korkeuden säätö ilman
 vastapainoa · Innowacyjna regulacja wysokości bez
 przeciwwagi

Pendelleuchte · Pendant
 ↔ 102 x 11 cm, ↑ 80 - 150 cm
 incl. 3 x SMD-LED, 9 W
 3 x 950 lm, 3.000 K



343610307 | Nickel matt · nickel mat
343610308 | Messing matt · brass mat



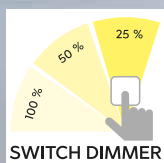

AICK

Metall, Aluminium gebürstet oder Schwarz matt · metal, brushed aluminium or black mat · metale, aluminium balayé ou noir mat · metaal, geborsteld aluminium of mat zwart · metal, aluminio pulido o estera negra · metallo, alluminio spazzolato o nero opaco · metal, aluminiu lucios sau negru mat · metalli, harjattu alumiini tai mattamusta · metal, aluminium szczotkowane lub czarny mat

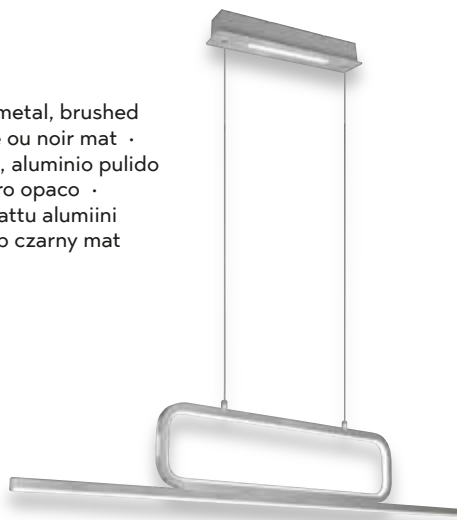

Pendelleuchte · Pendant

↔ 110 x 7,5 cm, ↓ 150 cm
incl. SMD-LED, 38 W
4.500 lm, 3.000 K



327210305 | Aluminium gebürstet ·
brushed aluminium

327210332 | Schwarz matt · black mat



GRANT

Aluminium gebürstet oder Messing matt, Schwarz matt · brushed aluminium or brass mat, black mat · aluminium balayé ou laiton mat, noir mat · geborsteld aluminium of messing mat, mat zwart · aluminio pulido o bronce mate, estera negra · alluminio spazzolato o ottone satinato, nero opaco · aluminium lucios sau bronz mat, negru mat · harjattu alumiini tai mattamessinki, mattamusta · aluminium szczotkowane lub miedz mat, czarny mat

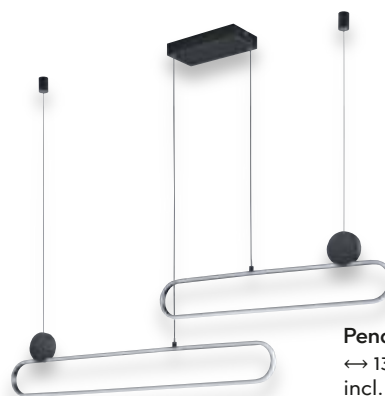
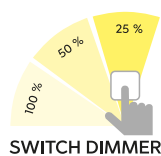
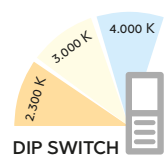

Pendelleuchte · Pendant

↔ 138 x 12 cm, ↑ 150 cm
incl. SMD-LED, 54 W
6.500 lm, 2.300 + 3.000 + 4.000 K



342710205 | Aluminium gebürstet · brushed aluminium

342710208 | Messing matt · brass mat



TUBULAR

Metall, Weiß matt oder Schwarz matt · metal, white mat or black mat ·
 metals, blanc mat ou noir mat · metaal, wit mat of mat zwart ·
 metal, estera blanca o estera negra · metallo, bianco opaco o nero opaco ·
 metal, alb mat sau negru mat · metalli, valkoinen matto tai musta matto ·
 metal, biały mat lub czarny mat



31 | Weiß matt · white mat

32 | Schwarz matt · black mat

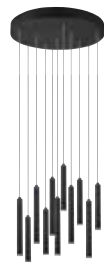

Pendelleuchte · Pendant
 Ø 40 cm, ↓ 150 cm
 incl. 11 x SMD-LED, 2,8 W
 11 x 350 lm, 3.000 K



321691131
321691132

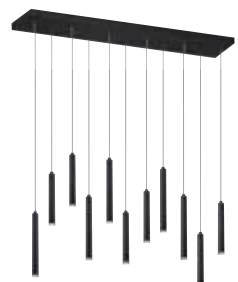

Pendelleuchte · Pendant
 ↔ 115 x 15 cm, ↓ 150 cm
 incl. 11 x SMD-LED, 2,8 W
 11 x 350 lm, 3.000 K



321611131
321611132



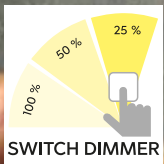

CURL

Metall, Weiß matt · metal, white ·
 metallo, bianco opaco · metal, alb mat · metalli, mattavalkoinen ·
 metal, biały mat

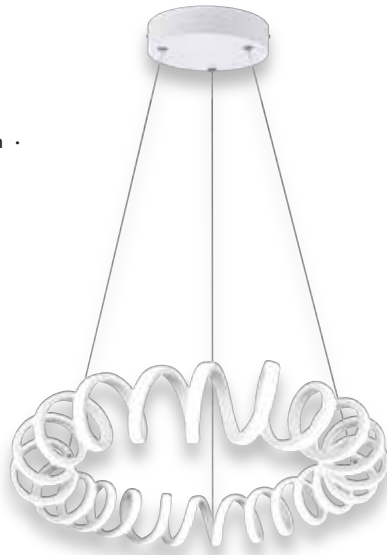

Pendelleuchte · Pendant
 Ø 55 cm, ↓ 150 cm
 incl. SMD-LED, 33 W
 5.000 lm, 4.000 K



325110131

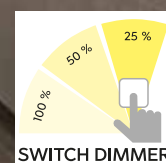

SWITCH DIMMER

DURBAN

Metall, Nickel matt oder Anthrazit · metal, nickel mat or anthracite ·
 metale, nickel mat ou antracite · metaal, nikkel mat of antraciet ·
 metal, níquel mate o antracita · metallo, nichel opaco o antracite ·
 metal, nichel mat sau antracit · metalli, harjattu teräs tai antrasiitti ·
 metal, nikiel mat lub antracyt



07 | Nickel matt · nickel mat

42 | Anthrazit · anthracite

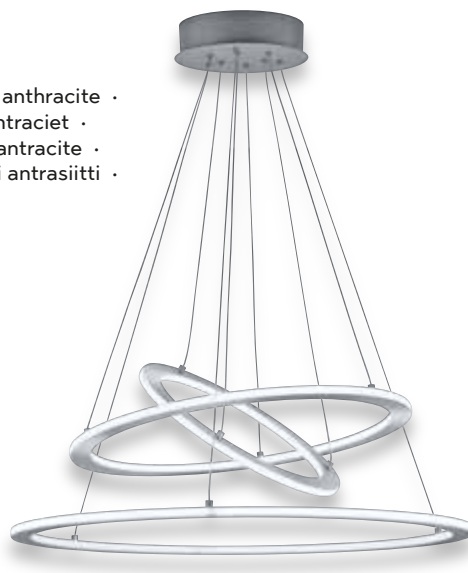

Pendelleuchte · Pendant
 Ø 80,3 cm, ↓ 200 cm
 incl. SMD-LED, 75 W
 8.900 lm, 3.000 K



321910307
 321910342



MARLEY

Metall · metal ·
metale · metaal · metal · metallo ·
metal · metalli · metal · metal

Empfohlen:

recommended: LED GU10, 4,5 W
345 lm, 3.000 K



956-55



01 | Weiß ·
white



07 | Nickel matt ·
nickel mat



31 | Weiß matt ·
white mat



32 | Schwarz matt ·
black mat



Pendelleuchte · Pendant
↓ 150 cm, ↔ 12 x 12 cm, Ø 6 cm
excl. 1 x GU10, max. 35 W



312400101
312400107
312400132

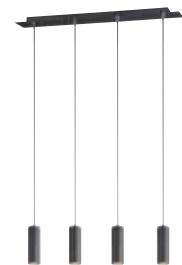

Pendelleuchte · Pendant
↔ 75 x 9 cm, ↓ 150 cm
excl. 4 x GU10, max. 35 W



312400401
312400407
312400432

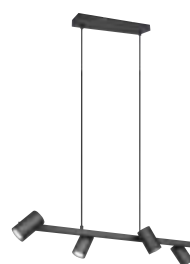
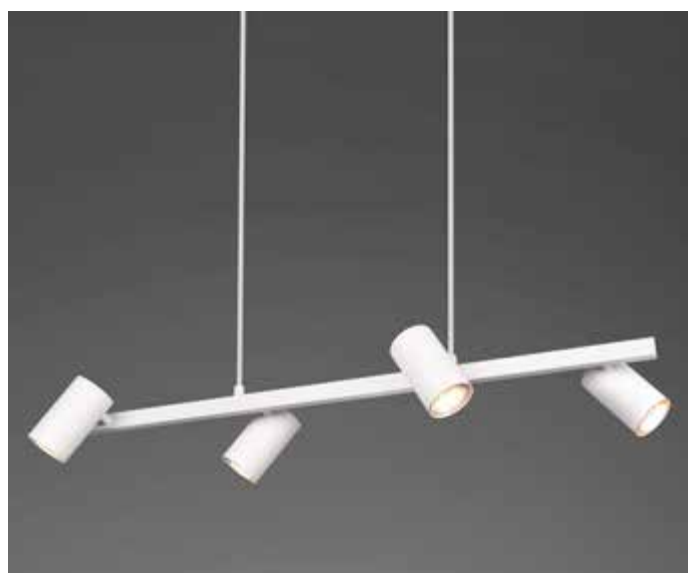

Pendelleuchte · Pendant
 ↔ 80 x 18 cm, ↓ 150 cm
 excl. 4 x GU10, max. 35 W



302400407
302400431
302400432



Pendelleuchte · Pendant
 ↔ 115 x 20 cm, ↓ 150 cm
 excl. 6 x GU10, max. 35 W



302400607
302400631
302400632



MARLEY

Metall, Altmessing oder Schwarz-Gold · metal, old brass or black-gold ·
 métal, laiton fumé ou noir et or · metaal, oud brons of zwart-goud ·
 metal, bronce viejo o negro-oro · metallo, ottone invecchiato o oro nero ·
 metal, bronz antic sau negru-auriu · metalli, antiikkimessinki tai musta-kulta ·
 metal, patyna lub czarno złoty

Empfohlen:
 recommended: LED GU10, 4,5 W
 345 lm, 3.000 K



956-55



04 | Altmessing ·
 old brass

80 | Schwarz-Gold ·
 black-gold

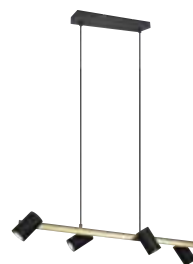

Pendelleuchte · Pendant
 ↔ 80 x 18 cm, ↓ 150 cm
 excl. 4 x GU10, max. 35 W



302400404
 302400480



Pendelleuchte · Pendant
 ↔ 115 x 20 cm, ↓ 150 cm
 excl. 6 x GU10, max. 35 W



302400604
 302400680



MARLEY

Metall, Holz · metal, wood ·
 Métal, bois · Metaal, hout · Metal, madera ·
 Metallo, di legno · Metal, lemn · Metalli, puu ·
 Metal, drewno



07 | Nickel matt / Holz ·
 nickel mat / wood



31 | Weiß matt / Holz ·
 white mat / wood



32 | Schwarz matt / Holz ·
 black mat / wood

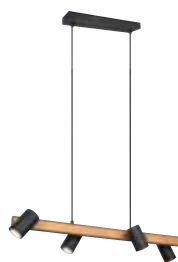
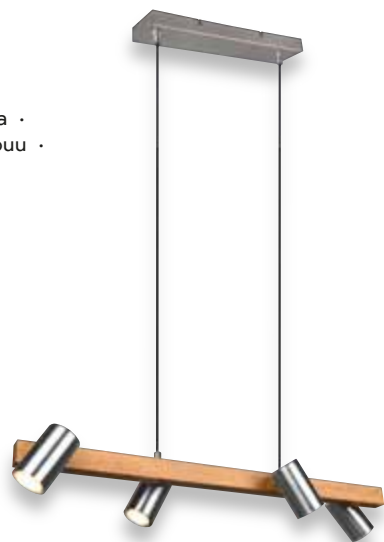

Pendelleuchte · Pendant
 ↔ 80 x 18 cm, ↓ 150 cm
 excl. 4 x GU10, max. 35 W



312490407
 312490431
 312490432



Pendelleuchte · Pendant
 ↔ 115 x 20 cm, ↓ 150 cm
 excl. 6 x GU10, max. 35 W



312490607
 312490631
 312490632



STANLEY

Nickel matt, Glas Weiß oder Schwarz matt, Glas rauchfarbig · nickel mat, glass white or black mat, glass smoke ·
 nickel mat, verre blanc ou noir mat, verre fumé · nikkell mat, glas wit of mat zwart, glas rookkleur ·
 níquel mate, vidrio blanco o estera negra, vidrio humo ·
 nichel opaco, vetro bianco o nero opaco, vetro fumé ·
 nichel mat, sticla alb sau negru mat, sticla fumuriu ·
 afstandsbiedening, lasi schakelaar tai mattamusta, lasi savu ·
 nikiel mat, szkło biały lub czarny mat, szkło przydymiony



07 | Nickel matt / Glas Weiß ·
nickel mat / glass white



32 | Schwarz matt / Glas rauchfarbig ·
black mat / glass smoke



Pendelleuchte · Pendant
 ↔ 55 x 19 cm, ↓ 150 cm
 excl. 2 x E27, max. 40 W



319500207
319500232



Pendelleuchte · Pendant
 ↔ 95 x 19 cm, ↓ 150 cm
 excl. 3 x E27, max. 40 W



319500307
319500332





CLAYTON

Metall schwarz matt, Glas chrom bedampft · metal black mat, chrome plated glass ·
 métal noir mat, verre plaqué chrome · metaal mat zwart, chroom opgedampt glas ·
 metal estera negra, vidrio cromado · metallo nero opaco, vetro verniciato cromo ·
 metal negru mat, sticla cromata · metalli mattamusta, kromipäällystetty lasi ·
 metal czarny mat, szkło chromowane

Empfohlen:
 recommended: Filament LED E27, 4 W
 470 lm, 2.700 K



987-400



Pendelleuchte · Pendant
 Ø 20 cm, ↓ 150 cm
 excl. 1 x E27, max. 28 W



310300132



Pendelleuchte · Pendant
 Ø 45 cm, ↓ 150 cm
 excl. 3 x E27, max. 28 W



310390332



Pendelleuchte · Pendant
 ↔ 120 cm, ↓ 150 cm
 excl. 5 x E27, max. 28 W



310300532





MELA

Metall, Weiß matt oder Schwarz matt, Glas · metal, white mat or black mat, glass ·
 métal, blanc mat ou noir mat, verre · metaal, wit mat of mat zwart, glas ·
 metal, estera blanca o estera negra, vidrio · metallo, bianco opaco o nero opaco, vetro ·
 metal, alb mat sau negru mat, sticla · metalli, mattavalkoinen tai mattamusta, lasi ·
 metal, biały mat lub czarny mat, szkło

Empfohlen:
 recommended: Filament LED E14, 4 W
 470 lm, 2.700 K



983-400



31 | Weiß matt · white mat

32 | Schwarz matt · black mat



Pendelleuchte · Pendant
 Ø 33 cm, ↓ 150 cm
 excl. 5 x E14, max. 25 W



313100531
313100532

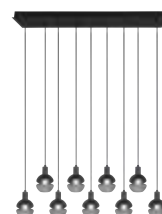

Pendelleuchte · Pendant
 ↔ 102 x 22 cm, ↓ 150 cm
 excl. 9 x E14, max. 25 W



313100931
313100932





CANDELA

Aluminium gebürstet/Chrom oder Messing matt/Messing poliert · brushed aluminium/chrome or brass mat/polished brass ·
 aluminium balayé/chrome ou laiton mat/laiton polis · geborsteld aluminium/chroom of messing mat/gepolijst messing ·
 aluminio pulido/cromo o bronce mate/bronce · alluminio spazzolato/cromo o ottone satinato/ottone lucido ·
 aluminiu lucios/crom sau bronz mat/bronz · harjattu alumiini/kromi tai mattamessinki/messinki ·
 aluminium szczotkowane/chrom lub msiądz mat/mosiądz polerowany

Empfohlen:
 recommended: Filament LED E14, 4 W
 400 lm, 2.700 K



989-479



03 | Messing poliert · polished brass



05 | Aluminium gebürstet · brushed aluminium



Pendelleuchte · Pendant
 Ø 56 cm, ↓ 150 cm
 excl. 4 x E14, max. 40 W



102000403
 102000405



ONTARIO

Glas goldfarbig · glass gold · Verre Or · Glas Goud ·
Vidrio Oro · Vetro Oro · Sticla Aur · Lasi Kultaa ·
Szkło Złota



Pendelleuchte · Pendant
↓ 155 cm, Ø 51 cm
excl. 1 x E27, max. 60 W



315200179



MINSK

Metall, Acryl · metal, acryl ·
 metale, acryl · metaal, acryl · metal, acrílico ·
 metallo, acrílico · metal, acrílico · metalli, akryyli · metal, akryl

Empfohlen:
 recommended: Filament LED E14, 4 W
 470 lm, 2.700 K



989-400

Pendelleuchte · Pendant
 Ø 50 cm, ↑ max. 150 cm
 excl. 7 x E14, max. 28 W



308600706



LUCERNA

Chrom, Acryl · chrome, acryl ·
chrome, acryl · chroom, acryl · cromo, acrílico · cromo, acrilico ·
crom, acrilic · kromi, akryyli · chrom, akryl

Empfohlen:
recommended: Filament LED E14, 4 W
470 lm, 3.000 K



990-400



Lüster · Chandelier
Ø 52 cm, ↑ 150 cm
excl. 5 x E14, max. 40 W



101600506



Lüster · Chandelier
Ø 68,5 cm, ↑ 150 cm
excl. 8 x E14, max. 40 W



101600806



ROMINO II

Metall, Schwarz matt, innen goldfarbig · metal, black mat, gold colored inside ·
 métal, noir mat, or · metaal, mat zwart, binnenkant goudkleur · metal, estera negra, interior en color dorado ·
 metallo, nero opaco, interno colore oro · metal, negru mat, interior culoare aurie ·
 metalli, mattamusta, sisäosa kullanvärinen · metal, czarny mat, wewnątrz złoty

Empfohlen:

recommended: Filament LED E27, 7 W
 806 lm, 2.700 K



985-6810



Pendelleuchte · Pendant
 Ø 50 cm, ↓ 150 cm
 excl. 1 x E27, max. 60 W



308000132



LORELEY

Chrom, Acryl, Stoffschirm · chrome, acryl, fabric shade ·
 chrome, acryl, abat-jour tissu · chroom, acryl, Stoffen kap ·
 cromo, acrílico, Pantalla de tela · cromo, acrílico, paralume in tessuto ·
 crom, acrílic, abajur textil · kromi, akryyli, kangas varjostin ·
 chrom, akryl, Klosz z materiału

Empfohlen:
 recommended: Filament LED E14, 4 W
 470 lm, 2.700 K



989-400



Pendelleuchte · Pendant
 Ø 50 cm, ↓ 150 cm
 excl. 3 x E14, max. 40 W



309300302



CHIRON

Aluminium, Messing matt, Schwarz matt · aluminium, brass mat, black mat ·
 aluminium, laiton mat, noir mat · aluminium, messing mat, mat zwart ·
 aluminio, bronce mate, estera negra · alluminio, ottone satinato, nero opaco ·
 aluminiu, bronz mat, negru mat · alumiini, mattamessinki, mattamusta ·
 aluminium, mosiądz mat, czarny mat



Pendelleuchte · Pendant
 Ø 20 cm, ↑ 150 cm
 excl. 1 x E27, max. 40 W



310800108



Pendelleuchte · Pendant
 Ø 45 cm, ↑ 150 cm
 excl. 1 x E27, max. 40 W



310890108



Pendelleuchte · Pendant
 ↔ 90 x 20 cm, ↑ 150 cm
 excl. 3 x E27, max. 40 W



310800308



CHIRAZ

Metall, Schwarz matt, goldfarbig · metal, black mat, gold ·
 métal, noir mat, or · metaal, mat zwart, goud · metal, estera negra, oro ·
 metallo, nero opaco, oro · metal, negru mat, aur · metalli, mattamusta, kultaa ·
 metal, czarny mat, złota

Empfohlen:
 recommended: Filament LED E14, 4 W
 470 lm, 2.700 K



983-400



Pendelleuchte · Pendant
 ↔ 63 x 20 cm, ↓ 150 cm
 excl. 3 x E14, max. 25 W



310500332



Pendelleuchte · Pendant
 ↔ 90,5 x 32,5 cm, ↓ 150 cm
 excl. 6 x E14, max. 25 W



310500632



CORTEZ

Metall, weiß matt, Stoffschirm · metal, white mat, fabric shade ·
 metale, blanc mat, abat-jour tissu · metaal, wit mat, Stoffen kap ·
 metal, estera blanca, Pantalla de tela · metallo, bianco opaco, paralume in tessuto ·
 metal, alb mat, abajur textil · metalli, mattavalkoinen, kangas varjostin ·
 metal, biały mat, Klosz z materiału · metal, beyaz mat, Kumaş şapka

Empfohlen:

recommended: LED E14, 3,5 W
 320 lm, 3.000 K



989-40



Pendelleuchte · Pendant
 Ø 52 cm, ↓ 150 cm
 excl. 3 x E14, max. 28 W



110600331



Pendelleuchte · Pendant
 Ø 70 cm, ↓ 150 cm
 excl. 5 x E14, max. 28 W



110600531



LIVIA

Metall Schwarz matt, goldfarbig · metal black mat, gold ·
 metale noir mat, or · metaal mat zwart, goud · metal estera negra, oro ·
 metallo nero opaco, oro · metal negru mat, aur · metalli musta matto, kultaa ·
 metal czarny mat, zlota

Empfohlen:
 recommended: Filament LED E14, 4 W
 470 lm, 3.000 K



990-400



Pendelleuchte · Pendant
 Ø 46,8 cm, ↓ 150 cm
 excl. 3 x E14, max. 28 W



101700332



Pendelleuchte · Pendant
 Ø 57,5 cm, ↓ 150 cm
 excl. 5 x E14, max. 28 W



101700532



FILO

Metall Schwarz matt, Glas Weiß · metal black mat, glass white ·
 metale noir mat, verre blanc · metaal mat zwart, glas wit · metal estera negra, vidrio blanco ·
 metallo nero opaco, vetro bianco · metal negro mat, sticla alb · metalli mattamusta, lasi valkoinen ·
 metal czarny mat, szkło biały

Empfohlen:

recommended: LED E27, 10 W
 806 lm, 3.000 K



988-10



Pendelleuchte · Pendant

↓ 150 cm, Ø 40 cm
 excl. 1 x E27, max. 60 W



313900132



FLETCHER

Metall, schwarz matt · metal, black mat ·
 metale, noir mat · metaal, mat zwart · metal, estera negra ·
 metallo, nero opaco · metal, negru mat · metalli, mattamusta · metal, czarny mat

Empfohlen:
 recommended: Filament LED E14, 4 W
 470 lm, 2.700 K



983-400



Pendelleuchte · Pendant
 ↔ 105 x 15 cm, ↓ 150 cm
 excl. 4 x E14, max. 40 W



313300432



ZUCCA

Chrom, Acryl · chrome, acryl ·
 chrome, acryl · chroom, acryl · cromo, acrílico ·
 cromo, acrílico · crom, acrílico · kromi, akryyli · chrom, akryl



00 | Transparent · transparent



06 | Chrom · chrome

Empfohlen:
 recommended: Filament LED E27, 7 W
 806 lm, 2.700 K



985-6810

Pendelleuchte · Pendant

Ø 40 cm, ↓ 150 cm
 excl. 1 x E27, max. 60 W



304100100
 304100106



SANNA

Metall · metal ·
metale · metaal · metal · metallo · metal · metalli · metal

01 | Weiß · white



02 | Schwarz · black



Empfohlen:
recommended: Filament LED E27, 7 W
806 lm, 3.000 K



987-600

Empfohlen:
recommended: Filament LED E27, 6 W
600 lm, 2.700 K



987-679



Pendelleuchte · Pendant
Ø 25 cm, ↓ 150 cm
excl. 1 x E27, max. 60 W



300900101
300900102



ONYX

Metall, Anthrazit, innen goldfarbig · metal, anthracite, gold colored inside ·
 metale, antracite, Or · metaal, antraciet, Binnenkant goudkleur ·
 metal, antracita, Interior en color dorado ·
 metallo, antracite, interno colore oro ·
 metal, antracit, interior culoare aurie ·
 metalli, antrasiitti, sisäosa kullanvärinen ·
 metal, antracyt, wewnątrz złoty

Empfohlen:
 recommended: Filament LED E27, 4 W
 470 lm, 2.700 K



987-400



Pendelleuchte · Pendant
 Ø 15 cm, ↓ 150 cm
 excl. 1 x E27, max. 42 W



301300142



Pendelleuchte · Pendant
 Ø 35 cm, ↓ 150 cm
 excl. 3 x E27, max. 42 W



301300342



Pendelleuchte · Pendant
 ↔ 90 x 15 cm, ↓ 150 cm
 excl. 4 x E27, max. 42 W



301300442





JASMIN

Metall · metal ·
metale · metaal · metal · metallo ·
metal · metalli · metal

Empfohlen:
recommended: Filament LED E14, 4 W
470 lm, 2.700 K



989-400



04 | Altmessing · old brass



62 | kupferfarbig antik · copper-coloured antique

Pendelleuchte · Pendant
Ø 19 cm, ↓ 150 cm
excl. 1 x E14, max. 40 W



303700104
303700162



CORD

Kupfer antik, Stoffkabel · antique copper, fabric sheathed cable ·
 cuivre ancien, câble gainé de tissu · antiek koper, kabel met
 stofmantel · cobre antiguo, cable forrado de tela · rame antico,
 cavo rivestito in tessuto · cupru antic, țesătură din fibră de sticlă ·
 antiikki kupari, kangaspäällysteinen kaapeli · antyczne miedzi,
 kabel z osłoną z tkaniny

Empfohlen · recommended:
 Filament LED E27, 4 W, 360 lm, 2.700 K



901-479



902-479



903-479



904-479



Pendelleuchte · Pendant
 ↓ 150 cm, ↔ max. 180 cm
 excl. 5 x E27, max. 60 W



310100562



LEVISTO

Nickel matt oder Messing matt, Glas alabasterfarbig ·
 nickel mat or brass mat, alabaster-coloured glass ·
 nickel mat ou laiton mat, verre couleur albâtre · nikkell mat of
 messing mat, albastkleurig glas · níquel mate o bronze mate, vidrio
 de color alabastro · nichel opaco o ottone satinato, vetro colore
 alabastro · nichel mat sau bronz mat, sticla culoare alabastru ·
 harjattu teräs tai mattamessinki, lasi alabasteri väri · nikiel mat lub
 mosiądz mat, szkło alabaster kolor



incl.
 LED E14, 5 W
 400 lm, 3.000 K

983-60

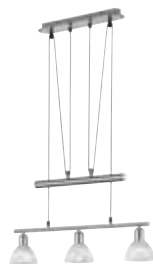

Pendelleuchte · Pendant
 ↔ 60,5 cm, ↓ 95 - 160 cm
 incl. 3 x LED E14, 5 W
 3 x 400 lm, 3.000 K



371010307
371010308

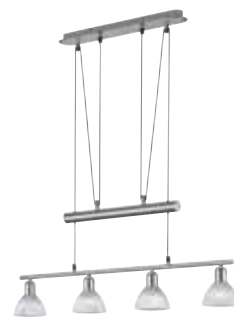

Pendelleuchte · Pendant
 ↔ 80 cm, ↓ 95 - 160 cm
 incl. 4 x LED E14, 5 W
 4 x 400 lm, 3.000 K



371010407
371010408

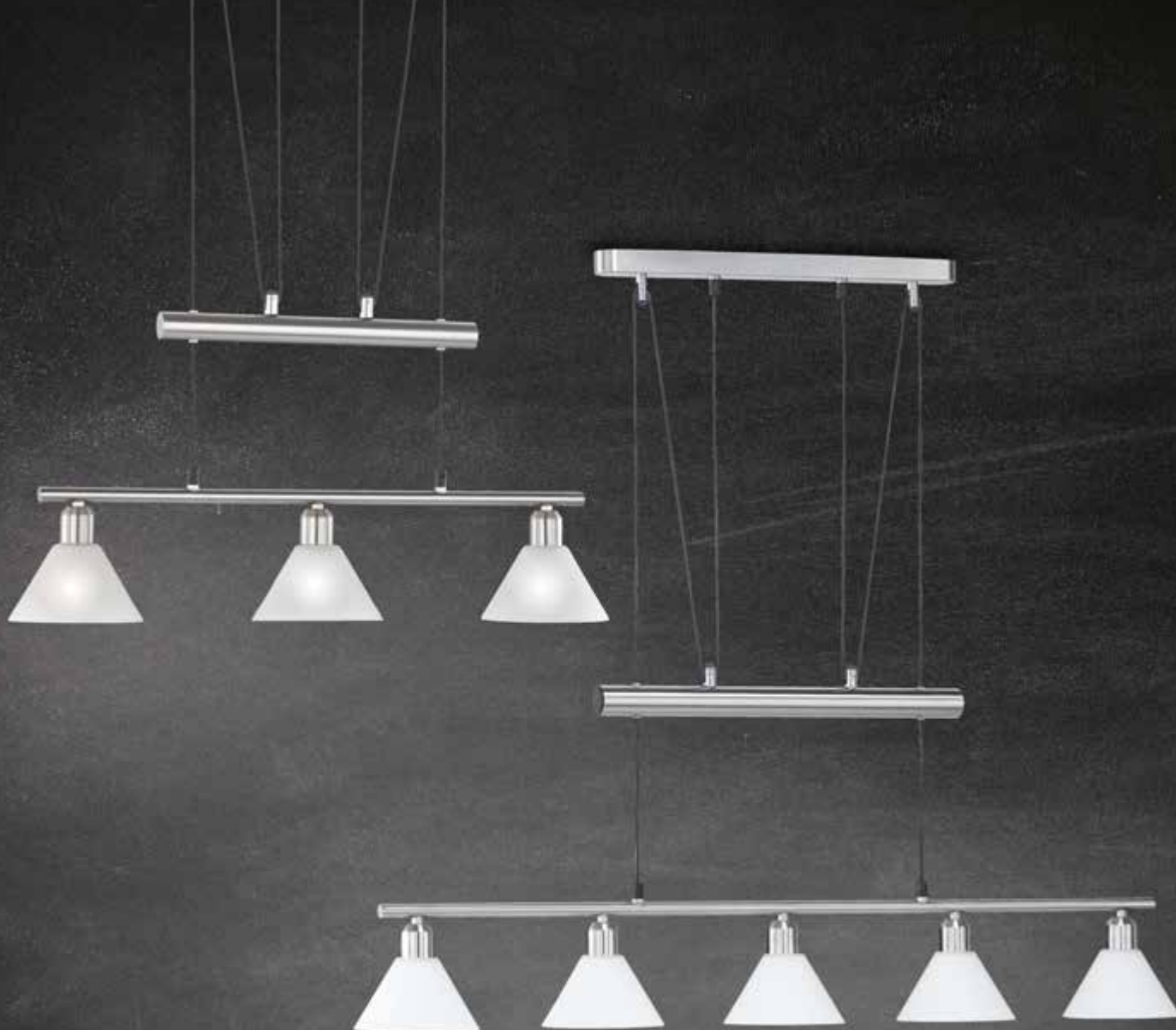

STAMINA

Nickel matt, Glas matt · nickel mat, mat glass ·
nickel mat, verre mat · nikkell mat, mat glas ·
níquel mate, vidrio mate · nichel opaco, vetro
sabbaiato · nichel mat, sticla mata · harjattu
teräs, mattalasi · nikiel mat, szkło matowane

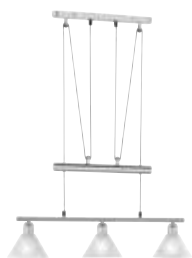

Pendelleuchte · Pendant
↔ 66 x 14 cm, ↓ 80 - 180 cm
excl. 3 x E14, max. 40 W



3751031-07

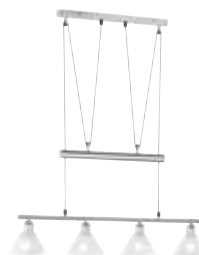

Pendelleuchte · Pendant
↔ 80 x 14 cm, ↓ 80 - 180 cm
excl. 4 x E14, max. 40 W



3751041-07

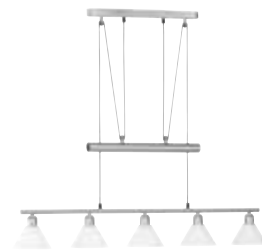

Pendelleuchte · Pendant
↔ 102 x 14 cm, ↓ 80 - 180 cm
excl. 5 x E14, max. 40 W



3751051-07

Empfohlen:
recommended: LED E14, 3,5 W
320 lm, 3.000 K



983-40

PAPER

Papier, Weiß · paper, white ·
papier, blanc · papier, wit · papel, blanco ·
carta, bianco · hartie, alb · paperi, valkoinen · papier, biały



Pendelleuchte · Pendant

Ø 40 cm
excl. 1 x E27, max. 60 W
VE / moq: 25



3490400-00



260



↓ 73,5 cm
excl. 1 x E27, max. 60 W
VE / moq: 25



3590010-01

DIEGO

Kunststoff, Weiß, Glas · plastic, white, glass ·
Plastique, Blanc, Verre · Kunststof, Wit, Glas ·
Plástico, Blanco, Vidrio · Plastica, Bianco, Vetro ·
Plastic, Alb, Sticla · Muovi, Valkoinen, Lasi ·
Plastik, Biały, Szkło

Empfohlen:
recommended: LED E27, 5 W
400 lm, 3.000 K



986-60



Pendelleuchte · Pendant

Ø 30 cm, ↓ 125 cm
excl. 1 x E27, max. 40 W



301400101





VIOLA

Glas alabasterfarbig · alabaster-coloured glass ·
 verre couleur albâtre · albastkleurig glas · vidrio de color alabastro ·
 vetro colore alabastro · sticla culoare alabastru · lasi alabasteri väri ·
 szkło alabaster kolor

Empfohlen:

recommended: LED E27, 10 W
 806 lm, 3.000 K



988-110

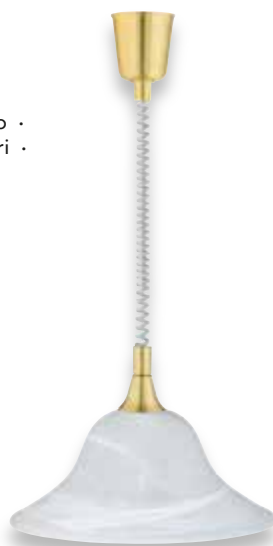

Pendelleuchte · Pendant

Ø 38,5 cm, ↓ 70 - 130 cm
 excl. 1 x E27, max. 40 W



301700107 | Nickel matt · nickel mat

301700108 | Messing matt · brass mat





Wand- & Deckenleuchten

Wall- & Ceiling lamps

Plafonniers & appliques

Wandlampen & plafonnières

Apliques y plafones

Applique e plafoniere

Plafoniere si aplice

Seinä- & katto

Sufitowe i ścienne



2.300 K



3.000 K



4.000 K



DIP SWITCH

Lichtfarben direkt an der Leuchte einstellbar · Colours directly adjustable at the lamp ·
 Les couleurs de la lumière peuvent être réglées directement sur le luminaire ·
 Lichtkleuren direct instelbaar op de lamp · Tonalidades de luz ajustables directamente en la lámpara ·
 Colori della luce regolabili direttamente sulla lampada · Colori ale luminii reglabile direct de la bec ·
 Valon väri asetettävissa suoraan valaisimesta · Barwy światła można ustawić bezpośrednio na oprawie





ZODIAC

Metall, Nickel matt oder Schwarz matt, Coffee · metal, nickel mat or black mat, coffee ·
 métal, nickel mat ou noir mat, café · metaal, nikkel mat of mat zwart, koffie ·
 metal, níquel mate o estera negra, café · metallo, nichel opaco o nero opaco, caffè ·
 metal, nichel mat sau negru mat, cafea · metalli, afstandsbediening tai mattamusta, kahvi ·
 metal, nikiel mat lub czarny mat, kawa

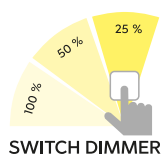

SWITCH DIMMER

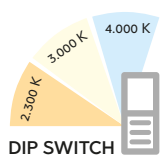

DIP SWITCH

Deckenleuchte · Ceiling lamp

Ø 50 cm, ↓ 10 cm
 incl. SMD-LED, 42 W
 5.100 lm, 2.300 + 3.000 + 4.000 K



644810107 | Nickel matt · nickel mat

644810132 | Schwarz matt · black mat



DIP SWITCH

Lichtfarben direkt an der Leuchte einstellbar · Colours directly adjustable at the lamp ·
 Les couleurs de la lumière peuvent être réglées directement sur le luminaire ·
 Lichtkleuren direct instelbaar op de lamp · Tonalidades de luz ajustables directamente en la lámpara ·
 Colori della luce regolabili direttamente sulla lampada · Culori ale luminii reglabile direct de la bec ·
 Valon väri asetettävissa suoraan valaisimesta · Barwy światła można ustawić bezpośrednio na oprawie

CAYA

Aluminium gebürstet oder Messing matt, Schwarz matt · brushed aluminium or brass mat, black mat ·
 Aluminium balayé ou Laiton mat, Noir mat · Geborsteld aluminium of Messing mat, Mat zwart ·
 Alluminio pulido o Bronce mate, Estera negra · Alluminio spazzolato o Ottone satinato, Nero opaco ·
 Aluminiu lucios sau Bronz mat, Negru mat · Harjattu alumiini tai Mattamessinki, mattamusta ·
 Aluminium szczotkowane lub Mosiądz mat, Czarny mat

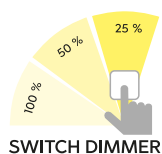

SWITCH DIMMER

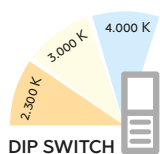

DIP SWITCH



05 | Aluminium gebürstet / Schwarz matt ·
 brushed aluminium / black mat

08 | Messing matt / Schwarz matt ·
 brass mat / black mat

Deckenleuchte · Ceiling lamp
 Ø 50 cm, ↓ 9 cm
 incl. SMD-LED, 58 W
 6.800 lm, 2.300 + 3.000 + 4.000 K



641910205
 641910208

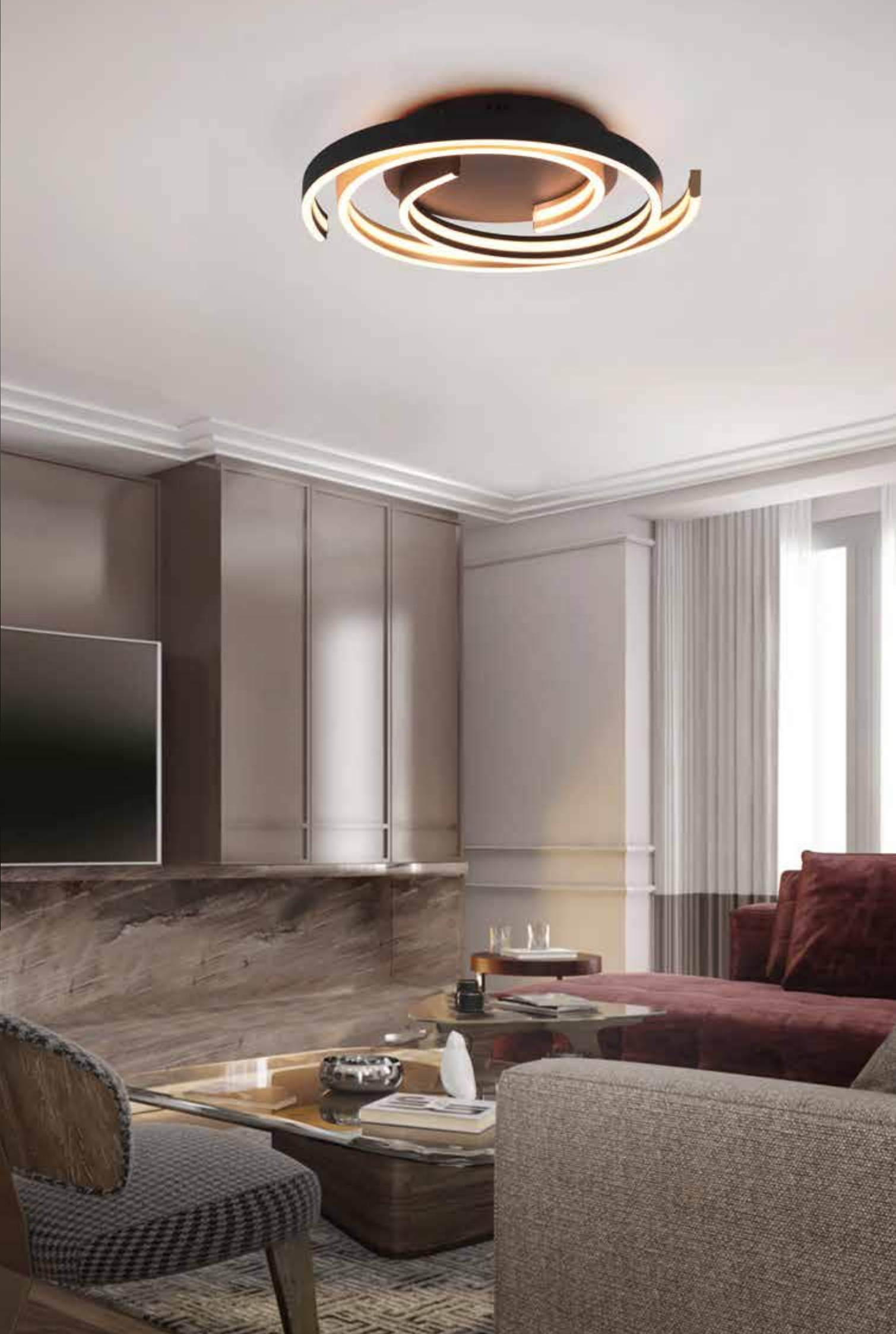

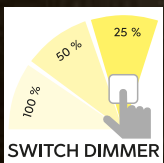

LUGO

Metall, Schwarz matt, goldfarbig · metal, black mat, gold ·
 Métal, Noir mat, Or · Metaal, Mat zwart, Goud · Metal, Estera negra, Oro · Metallo, Nero opaco, Oro ·
 Metal, Negru mat, Aur · Metalli, mattamusta, Kultaa · Metal, Czarny mat, Złota



Wandleuchte · Wall lamp
 ↔ 29 x 29 cm, ↗ 6,5 cm
 incl. SMD-LED, 12 W
 1.450 lm, 3.000 K



242910180



Deckenleuchte · Ceiling lamp
 ↔ 52,5 x 54 cm, ↓ 10 cm
 incl. SMD-LED, 28 W
 3.400 lm, 3.000 K



642910280



Deckenleuchte · Ceiling lamp
 ↔ 74 x 74 cm, ↓ 13 cm
 incl. SMD-LED, 50 W
 6.150 lm, 3.000 K



642910380





Deckenleuchte · Ceiling lamp
 ↔ 59 x 43 cm, ↑ 8,5 cm
 incl. SMD-LED, 29 W
 2.650 lm, 3.000 K



673810206
 673810232



Deckenleuchte · Ceiling lamp
 ↔ 85 x 60 cm, ↑ 8,5 cm
 incl. SMD-LED, 36 W
 3.250 lm, 3.000 K



673890206
 673890232

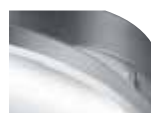

06 | Chrom · chrome



32 | Schwarz matt · black mat



GRANADA

Chrom, Weiß matt oder Schwarz matt, goldfarbig · chrome white mat, or black mat, gold ·
 chrome blanc mat, ou noir mat, or · chroom wit mat, of mat zwart, goud ·
 cromo estera blanca, o estera negra, oro · cromo bianco opaco,
 o nero opaco, oro · crom alb mat, sau negru mat, aur ·
 kromi mattavalkoinen, tai mattamusta, kultaa ·
 chrom biały mat, lub czarny mat, złota

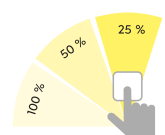

SWITCH DIMMER



Deckenleuchte · Ceiling lamp

↔ 71,5 x 63,5 cm, ↑ 10,5 cm

incl. SMD-LED, 36 W

4.300 lm, 3.000 K



673810306

673810332

07



32



65

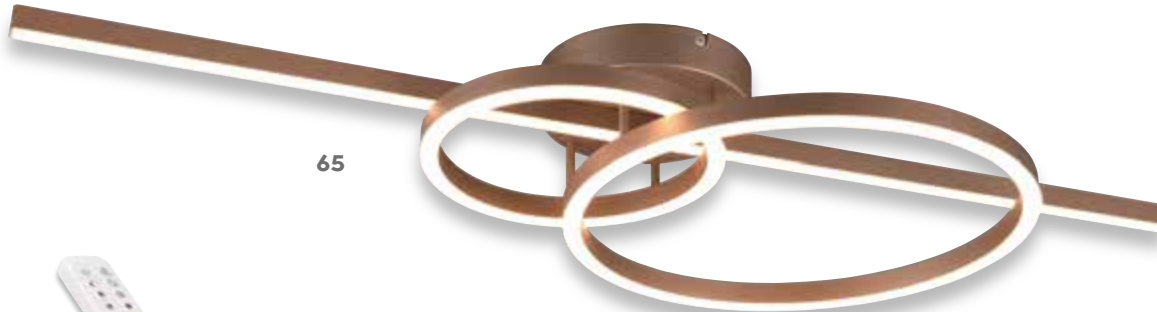

MONTILLA

Metall, Acryl · metal, acryl ·
metale, acryl · metaal, acryl · metal, acrílico ·
metallo, acrilico · metal, acrylic · metalli, akryyli · metal, akryl



Lichtfarbe stufenlos einstellbar ·
Light color infinitely variable



Integrierter Dimmer ·
Integrated dimmer



Memory Funktion ·
Memory function

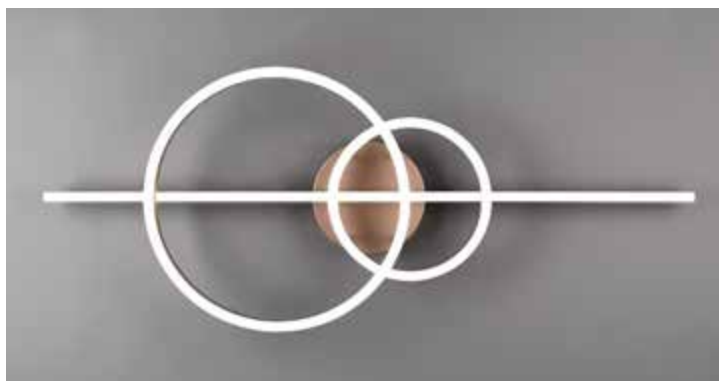



Kistalleffekt ·
crystal effect

Deckenleuchte · Ceiling lamp

↔ 100 x 40 cm, ↓ 12,5 cm
incl. SMD-LED, 54 W
6.300 lm, 2.700 – 6.000 K



- 643010306 | Chrom · chrome
- 643010307 | Nickel matt · nickel mat
- 643010332 | Schwarz matt · black mat
- 643010365 | Coffee · coffee

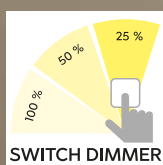

SWITCH DIMMER



Deckenleuchte · Ceiling lamp
 Ø 62,5 cm, ↑ 6 cm
 incl. SMD-LED, 30 W
 3.800 lm, 4.000 K



642110331



Deckenleuchte · Ceiling lamp
 ↔ 95,5 x 40 cm, ↑ 6,5 cm
 incl. SMD-LED, 37 W
 4.800 lm, 4.000 K



642110431



Deckenleuchte · Ceiling lamp
 Ø 62,5 cm, ↑ 6 cm
 incl. SMD-LED, 30 W
 3.600 lm, 3.000 K



642110332



Deckenleuchte · Ceiling lamp
 ↔ 95,5 x 40 cm, ↑ 6,5 cm
 incl. SMD-LED, 37 W
 4.600 lm, 3.000 K



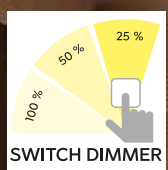

642110432



GROOVY

Metall, Kristallglas · metal, crystalglass ·
 métal, cristalverre · metaal, kristalglas · metal, cristalvidrio ·
 metallo, cristallovetro · metal, cristalsticla · metalli, kristallilasi · metal, kryształszkło

31 | Weiß matt · white mat

 4.000 Kelvin

32 | Schwarz matt · black mat





2.700 K



6.500 K

VIA

Metall · metal ·
metale · metaal · metal · metallo · metal · metalli · metal



Lichtfarbe stufenlos einstellbar ·
Light color infinitely variable



Integrierter Dimmer ·
Integrated dimmer



30 | holzfarbig · wood coloured

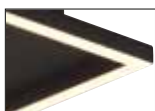

32 | Schwarz matt · black mat



31 | Weiß matt · white mat



80 | Schwarz-Gold · black-gold

Deckenleuchte · Ceiling lamp

↔ 50 x 50 cm, ↑ 7,5 cm
incl. SMD-LED, 36 W
4.200 lm, 2.700 - 6.500 K



620710330
620710331
620710332
620710380





IRVINE

Metall · metal ·
metale · metaal · metal · metallo · metal · metalli · metal

 Lichtfarbe stufenlos einstellbar ·
Light color infinitely variable

 Integrierter Dimmer ·
Integrated dimmer

 Memory Funktion ·
Memory function



07 | Nickel matt · nickel mat

08 | Messing matt · brass mat



31 | Weiß matt · white mat

42 | Anthrazit · anthracite

Deckenleuchte · Ceiling lamp

↔ 105 x 42 cm, ↓ 6,5 cm
incl. SMD-LED, 60 W
7.100 lm, 3.000 - 6.500 K



620010407
620010408
620010431
620010442





SEDONA

Metall, Holznachbildung · metal, wood imitation ·
 metals, imitation bois · metaal, houtimitatie ·
 metal, imitación de madera · metallo, effetto legno ·
 metal, imitație de lemn · metalli, puujäljitelmä ·
 metal, imitacja drewna

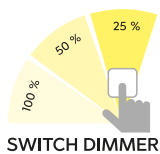

SWITCH DIMMER



Deckenleuchte · Ceiling lamp

Ø 80 cm, ↓ 8 cm
 incl. SMD-LED, 40 W
 4.800 lm, 3.000 K



673210306 | Chrom · chrome

673210332 | Schwarz matt, Holznachbildung ·
 black mat, wood imitation



TUCSON

Metall, Schwarz matt / Holznachbildung · metal, black mat / wood imitation ·
 Métal, Noir mat / imitation bois · Metaal, Mat zwart / houtimitatie · Metal, Estera negra / imitación de madera ·
 Metallo, Nero opaco / effetto legno · Metal, Negru mat / imitație de lemn · Metalli, mattamusta / puujäljitelmä ·
 Metal, Czarny mat / imitacja drewna

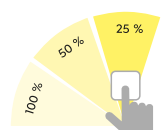

SWITCH DIMMER

Deckenleuchte · Ceiling lamp
 ↔ 104 x 42 cm, ↑ 8,5 cm
 incl. SMD-LED, 35 W
 4.400 lm, 3.000 K



672610332

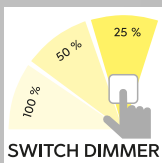
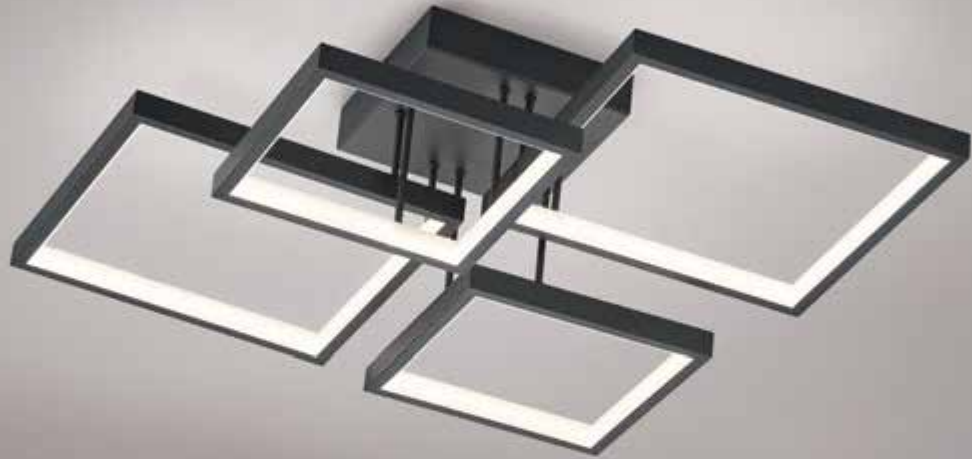

SORRENTO

Metall, schwarz matt · metal, black mat ·
 metale, noir mat · metaal, mat zwart · metal, estera negra ·
 metallo, nero opaco · metal, negru mat · metalli, mattamusta · metal, czarny mat



Deckenleuchte · Ceiling lamp
 ↔ 52,5 x 52,5 cm, ↑ 16 cm
 incl. SMD-LED, 24 W
 2.800 lm, 3.000 K



627710432



Deckenleuchte · Ceiling lamp
 ↔ 120,5 x 48,5 cm, ↑ 6 cm
 incl. SMD-LED, 34 W
 4.500 lm, 3.000 K



627710532

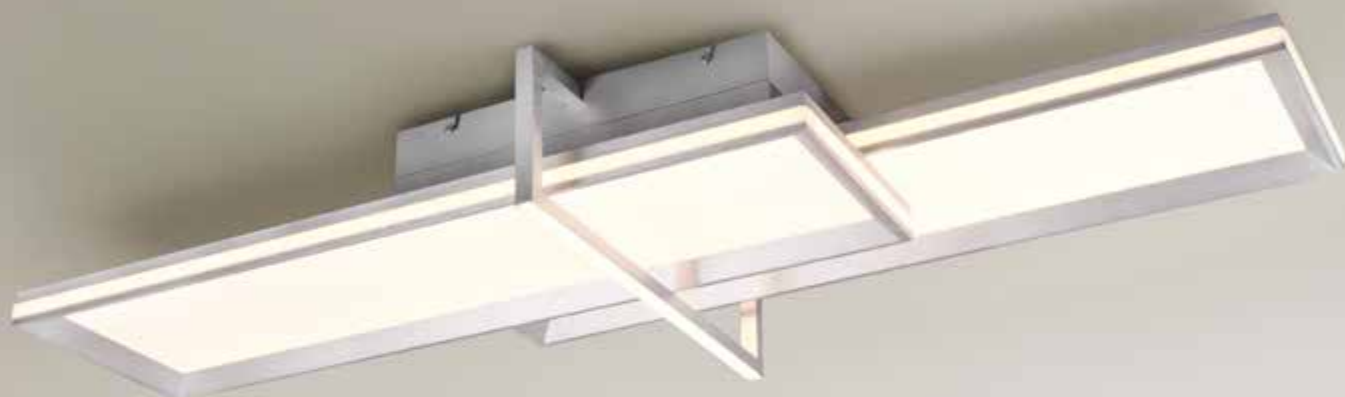

CHARLESTON

Metall, Aluminium gebürstet oder Anthrazit · metal, brushed aluminium or anthracite ·
 metale, aluminium balayé ou antracite · metaal, geborsteld aluminium of antraciet ·
 metal, aluminio pulido o antracita · metallo, alluminio spazzolato o antracite ·
 metal, aluminiu lucios sau antracit · metalli, harjattu alumiini tai antrasiitti ·
 metal, aluminium szczotkowane lub antracyt



Getrennt schaltbar ·
 Separately switchable



Memory Funktion ·
 Memory function



1x



2x



3x

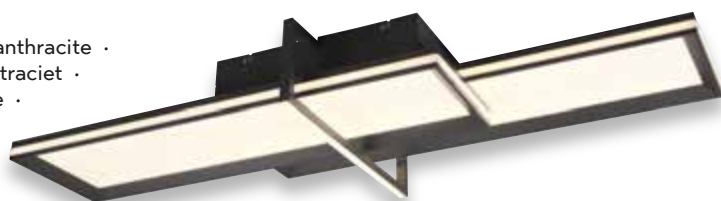

Deckenleuchte · Ceiling lamp

↔ 101 x 38 cm, ↓ 12,5 cm

incl. SMD-LED, 22 W

2.600 lm, 3.000 K

incl. SMD-LED, 13,5 W

1.800 lm, 3.000 K



672110505 | Aluminium gebürstet · brushed aluminium

672110542 | Anthrazit · anthracite

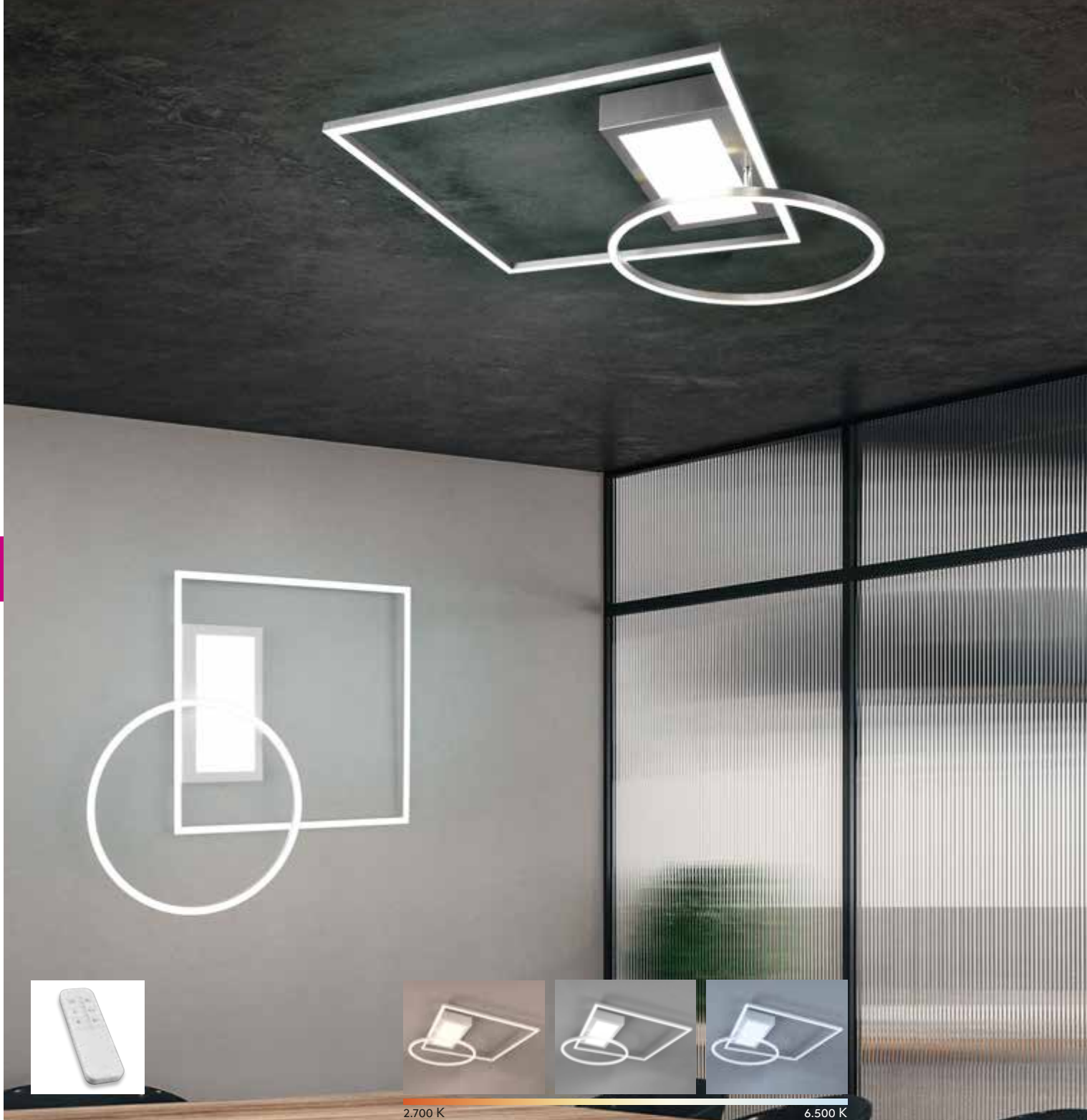

DOWNEY

Metall, Acryl · metal, acryl ·
 metale, acryl · metaal, acryl · metal, acrílico ·
 metallo, acrilico · metal, acrilic · metalli, akryyli · metal, akryl



Lichtfarbe stufenlos einstellbar ·
 Light color infinitely variable



Integrierter Dimmer ·
 Integrated dimmer



Memory Funktion ·
 Memory function

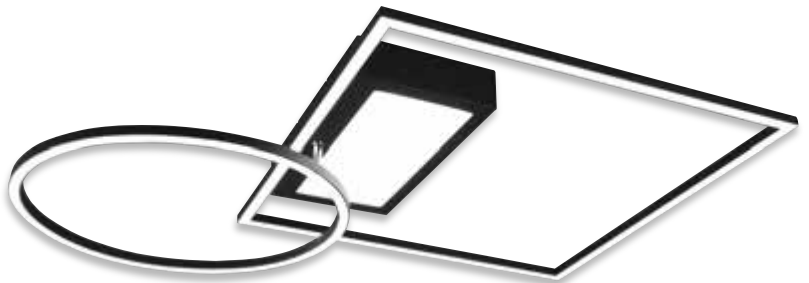

Schwenkbar · tiltable

Deckenleuchte · Ceiling lamp

↔ 64,5 x 86,5 cm, ↑ 89 cm
 incl. SMD-LED, 33 W
 4.600 lm, 2.700 - 6.500 K



620510307 | Nickel matt · nickel mat
 620510331 | Weiß matt · white mat
 620510332 | Schwarz matt · black mat



YAVA

Metall, Acryl · metal, acryl ·
 metale, acryl · metaal, acryl · metal, acrílico ·
 metallo, acrilico · metal, acrylic · metalli, akryyli · metal, akryl

 Lichtfarbe stufenlos einstellbar ·
 Light color infinitely variable

 Integrierter Dimmer ·
 Integrated dimmer



07 | Nickel matt · nickel mat



32 | Schwarz matt · black mat



Deckenleuchte · Ceiling lamp
 Ø 60 cm, ↑ 7 cm
 incl. SMD-LED, 56 W
 6.800 lm, 2.700 - 6.000 K



672310207
 672310232



GALE

Metall, Nickel matt, Weiß matt oder Schwarz matt · metal, nickel mat, white mat or black mat ·
 metale, nikel mat, blanc mat ou noir mat · metaal, nikkell mat, wit mat of mat zwart ·
 metal, níquel mate, estera blanca o estera negra · metallo, nichel opaco,
 bianco opaco o nero opaco · metal, nichel mat, alb mat sau negru mat ·
 metalli, harjattu teräs, mattavalkoinen tai mattamusta ·
 metal, nikiel mat, biały mat lub czarny mat

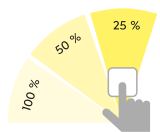

SWITCH DIMMER



07 | Nickel matt ·
nickel mat



31 | Weiß matt ·
white mat



32 | Schwarz matt ·
black mat



Deckenleuchte · Ceiling lamp
 ↔ 60 x 43 cm, ↑ 13,5 cm
 incl. SMD-LED, 38,5 W
 5.000 lm, 3.000 K



673916007
673916031
673916032



Deckenleuchte · Ceiling lamp
 ↔ 80 x 65 cm, ↑ 14,5 cm
 incl. SMD-LED, 50 W
 7.000 lm, 3.000 K



673918007
673918031
673918032



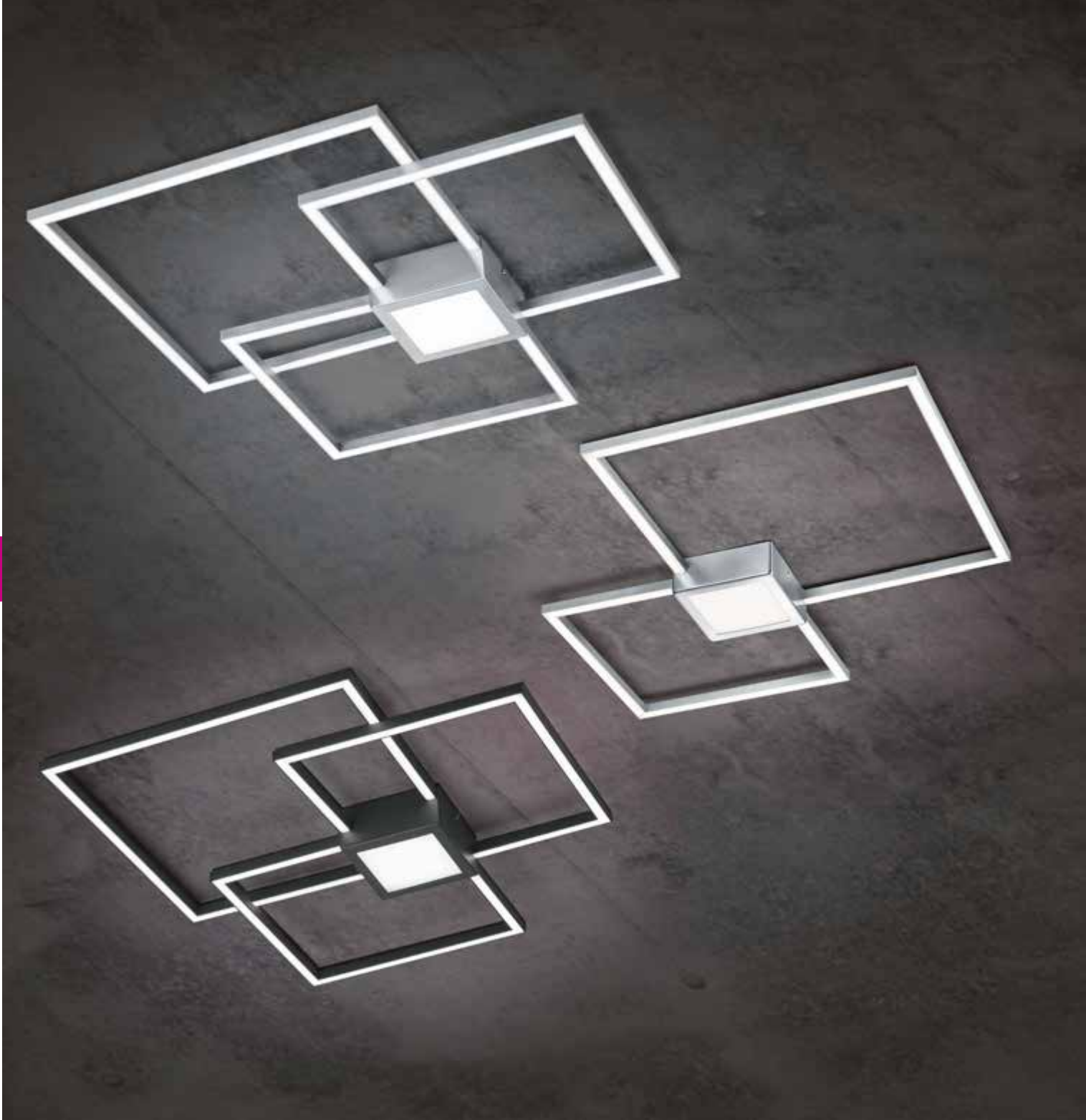

07 | Nickel matt · nickel mat



42 | Anthrazit · anthracite



Deckenleuchte · Ceiling lamp

↔ 65 x 65 cm, ↓ 5 cm
incl. SMD-LED, 28 W
2.600 lm, 3.000 K



676210307
676210342

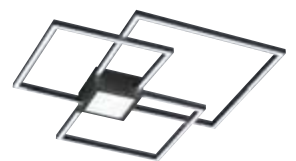

Deckenleuchte · Ceiling lamp

↔ 65,5 x 66,5 cm, ↓ 6,5 cm
incl. SMD-LED, 38 W
4.400 lm, 3.000 K



676210407
676210442



HYDRA

Chrom, Nickel matt, Weiß matt oder Anthrazit · chrome, nickel mat, white mat or anthracite ·
 chrome, nickel mat, blanc mat ou anthracite · chroom, nikkel mat, wit mat of antraciet ·
 cromo, níquel mate, estera blanca o antracita · cromo, nichel opaco,
 bianco opaco o antracite · crom, nichel mat, alb mat sau antracit ·
 kromi, harjattu teräs, mattavalkoinen tai antrasiitti · chrom, nikiel mat,
 biały mat lub antracyt

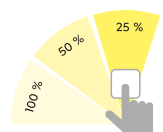

SWITCH DIMMER



31 | Weiß matt · white mat



4.000 Kelvin



Deckenleuchte · Ceiling lamp

↔ 65 x 65 cm, ↑ 5 cm
 incl. SMD-LED, 28 W
 3.200 lm, 4.000 K



676240331

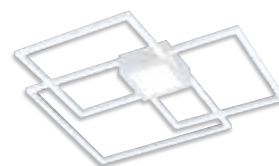

Deckenleuchte · Ceiling lamp

↔ 65,5 x 65 cm, ↑ 6,5 cm
 incl. SMD-LED, 38 W
 4.400 lm, 4.000 K



676240431



GANADO

Metall, Nickel matt oder Schwarz matt · metal, nickel mat or black mat ·
 metale, nickel mat ou noir mat · metaal, nikkell mat of mat zwart · metal, níquel mate o estera negra ·
 metallo, nichel opaco o nero opaco · metal, nichel mat sau negru mat · metalli, harjattu teräs tai mattamusta ·
 metal, nikiel mat lub czarny mat



RGBW Farbwechsler ·
 RGBW Colorchanging



Lichtfarbe stufenlos einstellbar ·
 Light color infinitely variable



Getrennt schaltbar ·
 Separately switchable



indirekte Beleuchtung ·
 indirect lighting

Deckenleuchte · Ceiling lamp

↔ 110 x 21,2 cm, ↑ 7 cm
 incl. SMD-LED, 37 W
 4.300 lm, 2.700 - 6.500 K
 incl. RGB-LED, 8 W



670710507 | Nickel matt · nickel mat

670710532 | Schwarz matt · black mat



WINONA

Metall, Nickel matt oder Schwarz matt · metal, nickel mat or black mat ·
 metale, nikel mat ou noir mat · metaal, nikkell mat of mat zwart ·
 metal, níquel mate o estera negra · metallo, nichel opaco o nero opaco ·
 metal, nichel mat sau negru mat · metalli, harjattu teräs tai mattamusta ·
 metal, nikiel mat lub czarny mat



RGBW Farbwechsler ·
 RGBW Colorchanging



Lichtfarbe stufenlos einstellbar ·
 Light color infinitely variable



Getrennt schaltbar ·
 Separately switchable



indirekte Beleuchtung ·
 indirect lighting



Deckenleuchte · Ceiling lamp

↔ 78 x 62 cm, ↑ 11,5 cm
 incl. SMD-LED, 28 W
 3.200 lm, 2.700 - 6.500 K
 incl. RGB-LED, 10 W



670810607 | Nickel matt · nikel mat
 670810632 | Schwarz matt · black mat





CRYSTEL

Chrom, Glas chrom bedampft, Acryl · chrome, chrome plated glass, acryl ·
 Chrome, Verre plaqué chrome, Acryl · Chroom, Chroom opgedampt glas, Acryl · Cromo, Vidrio cromado, Acrílico ·
 Cromo, Vetro verniciato cromo, Acrilico · Crom, Sticla cromata, Acrilic · Kromi, Kromipäällystetty lasi, Akryyli ·
 Chrom, Szkło chromowane, Akryl

Empfohlen:
 recommended: Filament LED E14, 4 W
 470 lm, 2.700 K



983-400



Deckenleuchte · Ceiling lamp
 Ø 34 cm, ↓ 17,5 cm
 excl. 3 x E14, max. 28 W



616700306



Deckenleuchte · Ceiling lamp
 Ø 50 cm, ↓ 23,5 cm
 excl. 5 x E14, max. 28 W



616700506

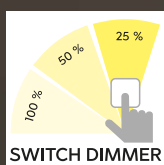

BULLET

Metall, Glas · metal, glass ·
 metale, verre · metaal, glas · metal, vidrio ·
 metallo, vetro · metal, sticla · metalli, lasi · metal, szkło



06 | Chrom, Glas chrom bedampft ·
 chrome, chrome plated glass



07 | Nickel matt, Glas weiß matt ·
 nickel mat, white mat glass



32 | Schwarz matt, Glas weiß matt ·
 black mat, white mat glass

Deckenleuchte · Ceiling lamp
 Ø 96 cm, ↑ 15,8 cm
 incl. 21 x SMD-LED, 1,5 W
 21 x 170 lm, 3.000 K



641412106
 641412107
 641412132





PEACOCK

Metall, schwarz matt · metal, black mat ·
 metale, noir mat · metaal, mat zwart · metal, estera negra · metallo, nero opaco ·
 metal, negru mat · metalli, mattamusta · metal, czarny mat

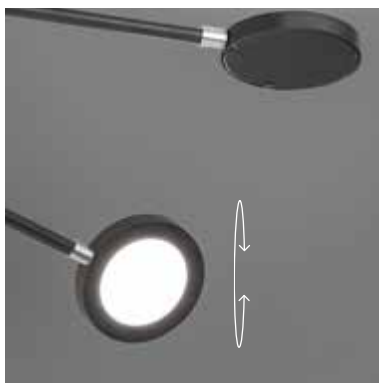
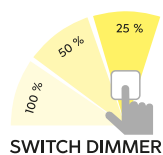

Deckenleuchte · Ceiling lamp

↔ 115 x 97,5 cm, ↓ 10,5 cm
 incl. 15 x SMD-LED, 2,6 W
 15 x 270 lm, 3.000 K





679511532



BODRUM

Chrom · chrome · chrome · chroom · cromo · cromo · crom · kromi · chrom · krom

 Lichtfarbe stufenlos einstellbar · Light color infinitely variable

 Memory Funktion · Memory function



3.000 K 6.500 K

Deckenleuchte · Ceiling lamp
 Ø 100 cm, ↑ 8,5 cm
 incl. 12 x SMD-LED, 2,2 W
 12 x 250 lm, 3.000 - 6.500 K
 incl. 1 x SMD-LED, 5 W
 550 lm, 3.000 - 6.500 K



673311306

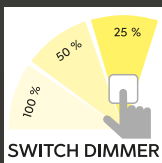

TIRIAC

Metall · metal ·
metale · metaal · metal · metallo · metal · metalli · metal



07 | Nickel matt · nickel mat



31 | Weiß matt · white mat

Deckenleuchte · Ceiling lamp

↔ 100 cm, ↑ 12 cm
incl. 3 x SMD, 9 W
3 x 950 lm, 3.000 K



671610307
671610331



OXFORD

Metall, weiß matt · metal, white mat ·
 metale, blanc mat · metaal, wit mat · metal, estera blanca · metallo, bianco opaco ·
 metal, alb mat · metalli, mattavalkoinen · metal, biały mat



4.000 Kelvin

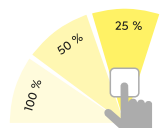

SWITCH DIMMER

Deckenleuchte · Ceiling lamp

↔ 102 x 78 cm, ↑ 5 cm
 incl. SMD-LED, 27 W
 3.600 lm, 4.000 K



674410331



Deckenleuchte · Ceiling lamp

↔ max. 245 cm, ↓ 6,5 cm
incl. SMD-LED, 25 W
3.000 lm, 3.000 K



674610507 | Nickel matt · nickel mat
674610532 | Schwarz matt · black mat





INDIRA

Metall, Nickel matt oder Schwarz matt, Acryl · metal, nickel mat or black mat, acryl ·
 metale, nickel mat ou noir mat, acryl · metaal, nikkell mat of mat zwart, acryl · metal, níquel mate o estera negra, acrílico ·
 metallo, nichel opaco o nero opaco, acrílico · metal, nichel mat sau negru mat, acrílic ·
 metalli, harjattu teräs tai mattamusta, akryyli · metal, nikiel mat lub czarny mat, akryl

Gibt Licht nach oben und unten · up and down lighting ·
 point lumineux en haut et en bas · lichtpunt boven en onder ·
 luz de arriba y abajo · luce su e giù · sus și în jos lumina ·
 ylös ja alas valoa · w górę iw dół światło

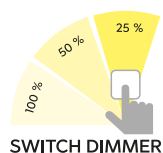

SWITCH DIMMER



Deckenleuchte · Ceiling lamp

↔ max. 345 cm, ↓ 6,5 cm
 incl. SMD-LED, 28 W
 3.500 lm, 3.000 K



674610707

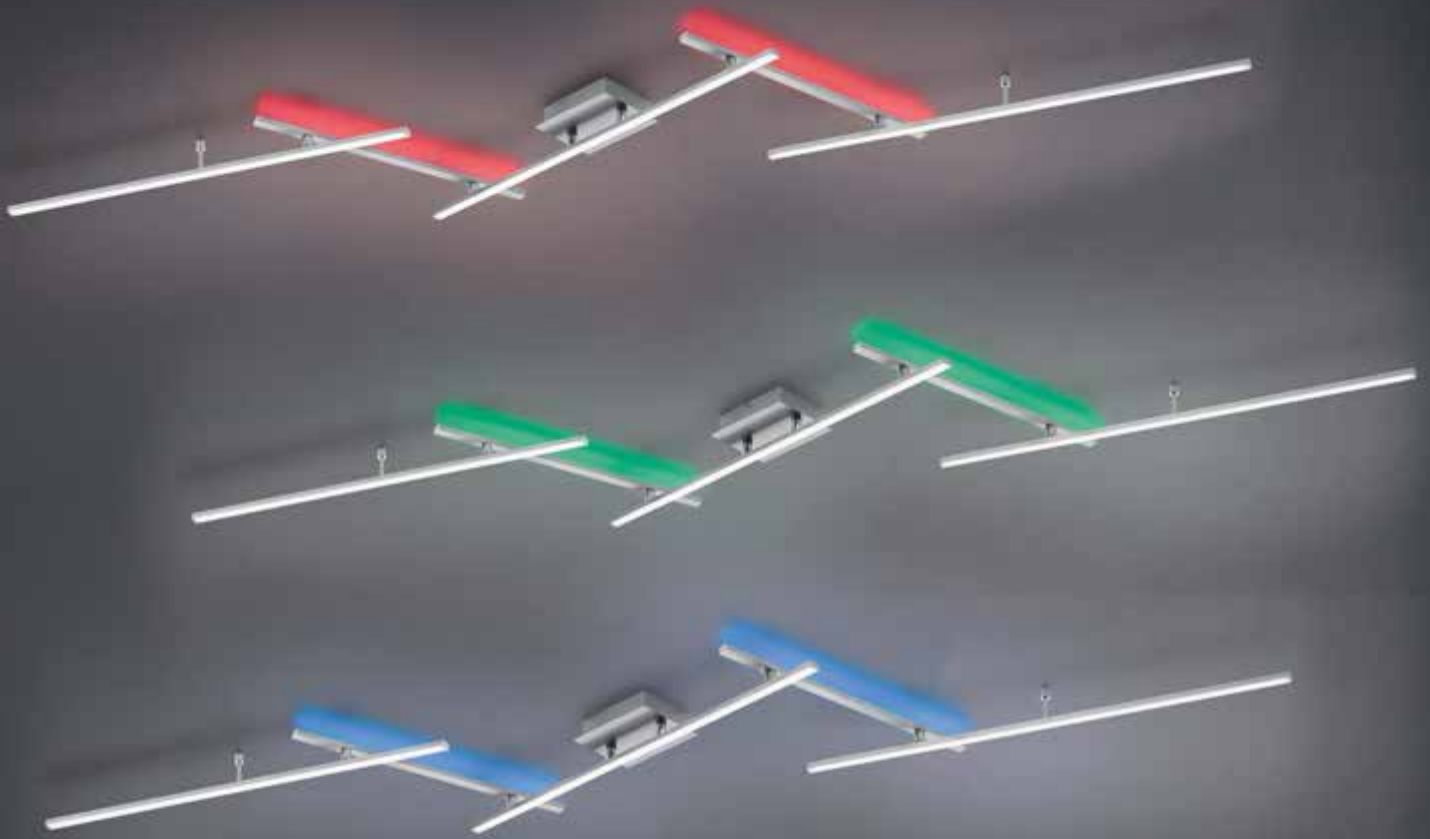

Gibt Licht nach oben und unten, getrennt schaltbar · up and down lighting, separately switchable ·
 point lumineux en haut et en bas, interrupteurs séparés · lichtpunt boven en onder, gescheiden schakelbaar ·
 luz de arriba y abajo, interruptores separados · luce su e giù, interruttori separati · sus și în jos lumina, intreruptoare separate ·
 ylös ja alas valoa, erikseen kytkettävissä · w górę i w dół światło, oddzielny przełącznik





ARVIN

Metall, Nickel matt oder Schwarz matt · metal, nickel mat or black mat ·
 metale, nickel mat ou noir mat · metaal, nikkell mat of mat zwart · metal, níquel mate o estera negra ·
 metallo, nichel opaco o nero opaco · metal, nichel mat sau negru mat · metalli, harjattu teräs tai mattamusta ·
 metal, nikiel mat lub czarny mat



RGBW Farbwechsler ·
 RGBW Colorchanging



Lichtfarbe stufenlos einstellbar ·
 Light color infinitely variable



Getrennt schaltbar ·
 Separately switchable



07 | Nickel matt · nickel mat



32 | Schwarz matt · black mat

Deckenleuchte · Ceiling lamp

↔ max. 245 x 50 cm, ↓ 8,5 cm

incl. SMD-LED, 22 W

2.600 lm, 2.700 - 6.500 K

incl. RGB-LED, 8 W



628410507

628410532



KAGAWA

Metall Weiß matt, Acryl · metal white mat, acryl ·
 metale blanc mat, acryl · metaal wit mat, acryl ·
 metal estera blanca, acrílico · metallo bianco opaco, acrilico ·
 metal alb mat, acrilic · metalli valkoinen matto, akryyli · metal biały mat, akryl



Lichtfarbe stufenlos einstellbar ·
 Light color infinitely variable



Memory Funktion ·
 Memory function



Nachtlicht ·
 Night light



Deckenleuchte · Ceiling lamp
 Ø 50 cm, ↓ 6 cm
 incl. SMD-LED, 40 W
 5.000 lm, 2.700 - 6.000 K



625815031



AKITA

Metall Weiß matt, Acryl · metal white mat, acryl ·
 metale blanc mat, acryl · metaal wit mat, acryl ·
 metal estera blanca, acrílico · metallo bianco opaco, acrilico ·
 metal alb mat, acrilic · metalli valkoinen matto, akryyli · metal biały mat, akryl



Lichtfarbe stufenlos einstellbar ·
 Light color infinitely variable



Memory Funktion ·
 Memory function



3.000 K

6.500 K

Deckenleuchte · Ceiling lamp

↔ 48 x 48 cm, ↑ 5,5 cm
 incl. SMD-LED, 56 W
 6.550 lm, 3.000 - 6.500 K



647110131



MITA

Metall Weiß matt, Acryl · metal white mat, acryl ·
 metale blanc mat, acryl · metaal wit mat, acryl ·
 metal estera blanca, acrílico · metallo bianco opaco, acrilico ·
 metal alb mat, acrylic · metalli valkoinen matto, akryyli · metal biały mat, akryl



Lichtfarbe stufenlos einstellbar ·
 Light color infinitely variable



Integrierter Dimmer ·
 Integrated dimmer



2.700 K

6.000 K

Deckenleuchte · Ceiling lamp

Ø 51 cm, ↑ 7 cm
 incl. SMD-LED, 74 W
 9.000 lm, 2.700 - 6.000 K



629210331

Deckenleuchte · Ceiling lamp

↔ 51,5 x 51,5 cm, ↑ 7 cm
 incl. SMD-LED, 76 W
 9.250 lm, 2.700 - 6.000 K



629219331



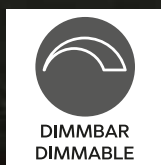
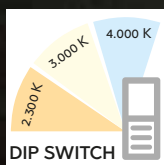

Lichtfarben direkt an der Leuchte einstellbar ·
 Colours directly adjustable at the lamp ·
 Les couleurs de la lumière peuvent être réglées directement sur le luminaire ·
 Lichtkleuren direct instelbaar op de lamp ·
 Tonalidades de luz ajustables directamente en la lámpara ·
 Colori della luce regolabili direttamente sulla lampada ·
 Culori ale luminii reglabile direct de la bec ·
 Valon väri asetettävissa suoraan valaisimesta ·
 Barwy światła można ustawić bezpośrednio na oprawie



2.300 K

3.000 K

4.000 K



WACO

Metall, Acryl · metal, acryl ·
 metale, acryl · metaal, acryl · metal, acrílico ·
 metallo, acrilico · metal, acrilic · metalli, akryyli · metal, akryl



31 | Weiß matt · white mat

32 | Schwarz matt · black mat

87 | titanfarbig · titan



Deckenleuchte · Ceiling lamp
 Ø 31 cm, ↓ 6,5 cm
 incl. SMD-LED, 28 W
 3.200 lm, 2.300 + 3.000 + 4.000 K

Deckenleuchte · Ceiling lamp
 Ø 49,5 cm, ↓ 6,5 cm
 incl. SMD-LED, 52,5 W
 6.200 lm, 2.300 + 3.000 + 4.000 K

Deckenleuchte · Ceiling lamp
 Ø 75 cm, ↓ 7 cm
 incl. SMD-LED, 100 W
 12.400 lm, 2.300 + 3.000 + 4.000 K



627413031
 627413032
 627413087

627415031
 627415032
 627415087

627417531
 627417532
 627417587



Getrennt schaltbar ·
Separately switchable



Lichtfarbe einstellbar ·
Adjustable light color



1x



2x



3x



2.300 K



3.000 K



4.000 K

DOHA

Metall, Acryl · metal, acryl ·
metale, acryl · metaal, acryl · metal, acrílico ·
metallo, acrilico · metal, acrylic · metalli, akryyli ·
metal, akryl

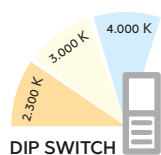

DIP SWITCH



08 | Messing matt · brass mat



31 | Weiß matt · white mat



32 | Schwarz matt · black mat



65 | Coffee · coffee

Deckenleuchte · Ceiling lamp
Ø 45 cm, ↑ 5,5 cm
incl. SMD-LED, 29 W
3.260 lm, 2.300 + 3.000 + 4.000 K



641310208
641310231
641310232
641310265





MORGAN

Metall, Acryl · metal, acryl ·
metale, acryl · metaal, acryl · metal, acrílico ·
metallo, acrilico · metal, acrylic · metalli, akryyli · metal, akryl



Lichtfarbe stufenlos einstellbar ·
Light color infinitely variable



Integrierter Dimmer ·
Integrated dimmer

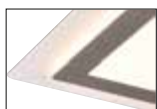

07 | Weiß matt / Nickel ·
white mat / nickel

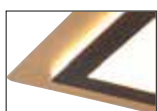

80 | Schwarz matt / goldfarbig ·
black mat / gold

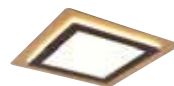

Deckenleuchte · Ceiling lamp

↔ 45 x 45 cm, ↑ 4,2 cm
incl. SMD-LED, 46 W
6.000 lm, 2.700 - 6.500 K



641510207
641510280



Deckenleuchte · Ceiling lamp

Ø 45 cm, ↑ 4,2 cm
incl. SMD-LED, 42 W
5.600 lm, 2.700 - 6.500 K



641519207
641519280



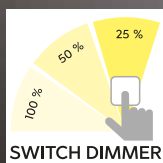

GIRONA

Metall, Acryl · metal, acryl ·
 metale, acryl · metaal, acryl · metal, acrílico ·
 metallo, acrilico · metal, acrilic · metalli, akryyli · metal, akryl



31 | Weiß matt · white mat

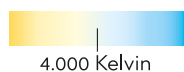

4.000 Kelvin



32 | Schwarz matt · black mat



Deckenleuchte · Ceiling lamp

Ø 45 cm, ↓ 11 cm
 incl. SMD-LED, 27 W
 3.200 lm, 3.000 K
(31 = 3.200 lm, 4.000 K)



671210131
671210132



2.700 K

6.500 K



Deckenleuchte · Ceiling lamp
Ø 60 cm, ↓ 12 cm
incl. SMD-LED, 48 W
5.600 lm, 2.700 - 6.000 K



671290131
671290132



Deckenleuchte · Ceiling lamp
 Ø 30 cm, ↑ 4,2 cm
 incl. SMD-LED, 15 W
 1.700 lm, 3.000 K



674093032



Deckenleuchte · Ceiling lamp
 Ø 45 cm, ↑ 4,2 cm
 incl. SMD-LED, 26 W
 3.000 lm, 3.000 K



674094532



Deckenleuchte · Ceiling lamp
 Ø 62 cm, ↑ 4,2 cm
 incl. SMD-LED, 31 W
 3.600 lm, 3.000 K



674096232



Deckenleuchte · Ceiling lamp
 ↔ 30 x 30 cm, ↑ 4,2 cm
 incl. SMD-LED, 15 W
 1.700 lm, 3.000 K



674013032



PHOENIX

Metall, Schwarz matt, Acryl · metal, black mat, acryl ·
 métal, noir mat, acryl · metaal, mat zwart, acryl · metal, estera negra, acrílico ·
 metallo, nero opaco, acrilico · metal, negru mat, acrilic · metalli, mattamusta, akryyli ·
 metal, czarny mat, akryl



Dimmbar ·
Dimmable



Deckenleuchte · Ceiling lamp
 ↔ 45 x 45 cm, ↓ 4,2 cm
 incl. SMD-LED, 26 W
 3.600 lm, 3.000 K



674014532



Deckenleuchte · Ceiling lamp
 ↔ 62 x 62 cm, ↓ 4,2 cm
 incl. SMD-LED, 31 W
 3.600 lm, 3.000 K



674016232



Deckenleuchte · Ceiling lamp
 ↔ 120 x 30 cm, ↓ 4,2 cm
 incl. SMD-LED, 31 W
 3.600 lm, 3.000 K



674011232



Deckenleuchte · Ceiling lamp
 Ø 30 cm, ↑ 4,2 cm
 incl. SMD-LED, 15 W
 1.700 lm, 3.000 K



674093007



Deckenleuchte · Ceiling lamp
 Ø 45 cm, ↑ 4,2 cm
 incl. SMD-LED, 26 W
 3.000 lm, 3.000 K



674094507



Deckenleuchte · Ceiling lamp
 Ø 62 cm, ↑ 4,2 cm
 incl. SMD-LED, 31 W
 3.600 lm, 3.000 K



674096207



Deckenleuchte · Ceiling lamp
 ↔ 30 x 30 cm, ↑ 4,2 cm
 incl. SMD-LED, 15 W
 1.700 lm, 3.000 K



674013007

PHOENIX

Metall, Nickel matt, Acryl · metal, nickel mat, acryl ·
 métal, nickel mat, acryl · metaal, nikkel mat, acryl · metal, níquel mate, acrílico ·
 metallo, nichel opaco, acrílico · metal, nichel mat, acrilic · metalli, harjattu teräs, akryyli ·
 metal, nikiel mat, akryl



Dimmbar ·
Dimmable



Deckenleuchte · Ceiling lamp
 ↔ 45 x 45 cm, ↓ 4,2 cm
 incl. SMD-LED, 26 W
 3.000 lm, 3.000 K



674014507



Deckenleuchte · Ceiling lamp
 ↔ 62 x 62 cm, ↓ 4,2 cm
 incl. SMD-LED, 31 W
 3.600 lm, 3.000 K



674016207



Deckenleuchte · Ceiling lamp
 ↔ 120 x 30 cm, ↓ 4,2 cm
 incl. SMD-LED, 31 W
 3.600 lm, 3.000 K



674011207



LUGANO

Stoffschild, Acryl · fabric shade, acryl ·
abat-jour tissu, acryl · Stoffen kap, acryl · Pantalla de tela, acrílico ·
paralume in tessuto, acrilico · abajur textil, acrilic · kangas varjostin, akryyli ·
Klosz z materiału, akryl



01 | Weiß · white

11 | Grau · grey



Deckenleuchte · Ceiling lamp
Ø 30 cm, ↑ 9 cm
incl. SMD-LED, 11 W
1.200 lm, 3.000 K

621911201
621911211



Deckenleuchte · Ceiling lamp
Ø 40 cm, ↑ 10,5 cm
incl. SMD-LED, 22 W
2.500 lm, 3.000 K



621912401
621912411

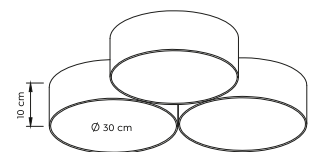

Deckenleuchte · Ceiling lamp
↔ 64,5 x 64,5 cm, ↑ 14 cm
incl. SMD-LED, 38 W
4.200 lm, 3.000 K



621910317
mehrfarbig · multicolor



Lichtfarbe stufenlos einstellbar ·
Light color infinitely variable



Integrierter Dimmer ·
Integrated dimmer



Memory Funktion ·
Memory function



Deckenleuchte · Ceiling lamp
Ø 60 cm, ↑ 10 cm
incl. SMD-LED, 42 W
4.900 lm, 3.000 - 5.000 K



621914001
621914011



Deckenleuchte · Ceiling lamp
Ø 75 cm, ↑ 10 cm
incl. SMD-LED, 60 W
5.000 lm, 3.000 - 5.000 K



621915501
621915511

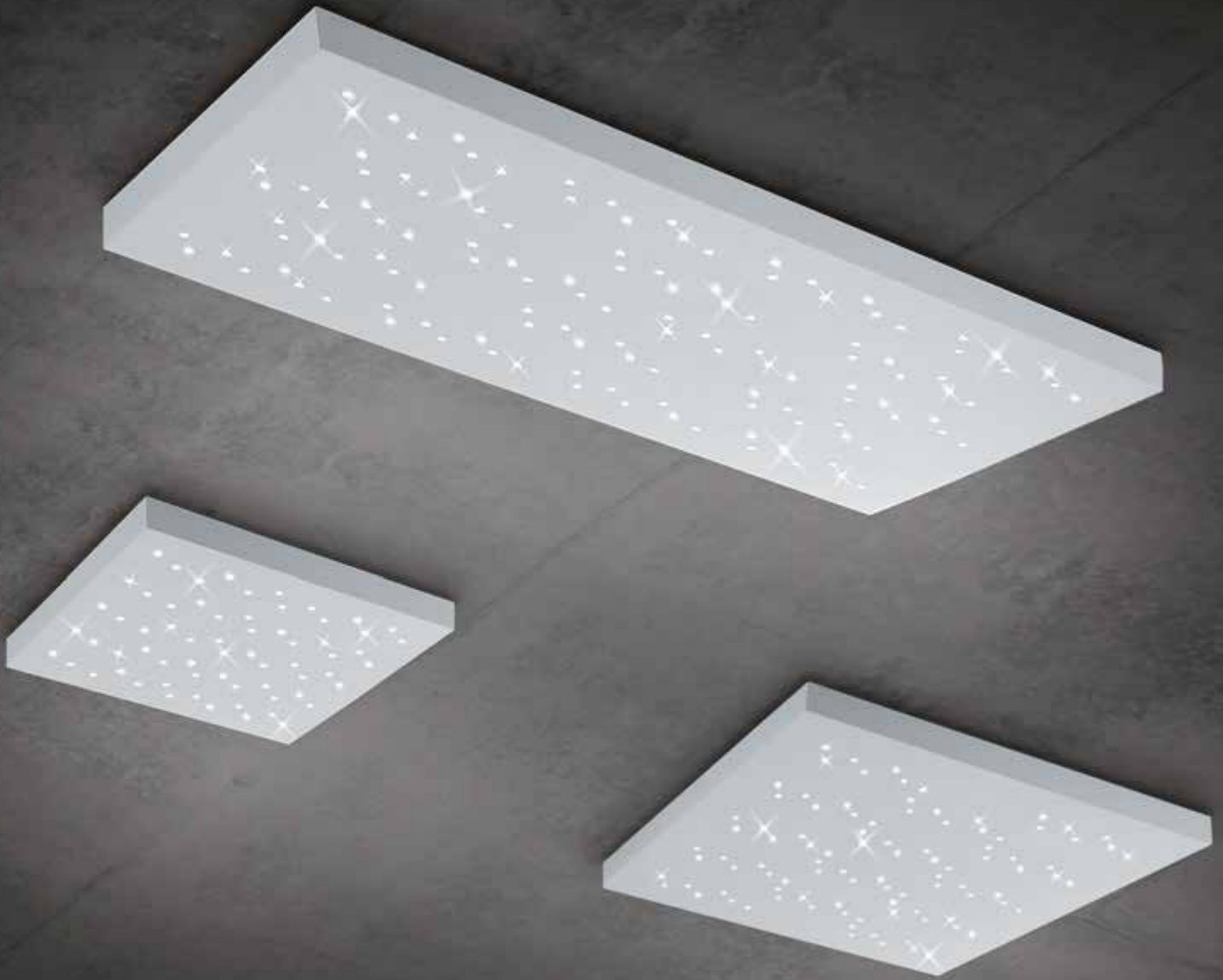

TITUS

Metall, Weiß matt · metal, white mat ·
 metale, blanc mat · metaal, wit mat · metal, estera blanca ·
 metallo, bianco opaco · metal, alb mat · metalli, valkoinen matto ·
 metal, biały mat



Lichtfarbe stufenlos einstellbar ·
 Light color infinitely variable



Integrierter Dimmer ·
 Integrated dimmer



Deckenleuchte · Ceiling lamp
 ↔ 50 x 50 cm, ↑ 4,5 cm
 incl. SMD-LED, 22 W
 2.800 lm, 3.000 - 6.000 K



676615031



Deckenleuchte · Ceiling lamp
 ↔ 75 x 75 cm, ↑ 4,5 cm
 incl. SMD-LED, 36 W
 3.300 lm, 3.000 - 6.000 K



676617531



Deckenleuchte · Ceiling lamp
 ↔ 110 x 60 cm, ↑ 4,5 cm
 incl. SMD-LED, 48 W
 6.000 lm, 3.000 - 6.000 K



676611031

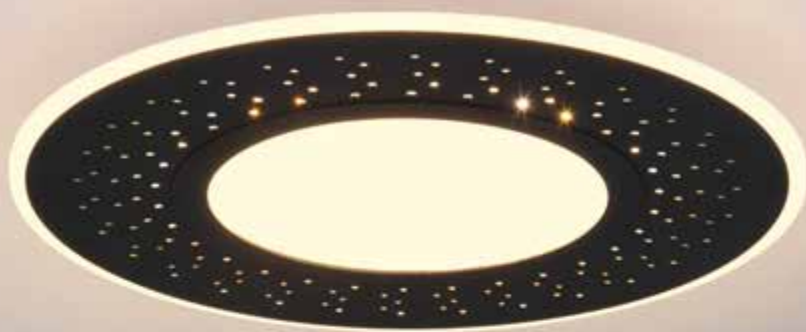

Getrennt schaltbar ·
Separately switchable



VERUS

Metall, Acryl · metal, acryl ·
metale, acryl · metaal, acryl · metal, acrílico ·
metallo, acrilico · metal, acrylic · metalli, akryyli · metal, akryl



Lichtfarbe stufenlos einstellbar ·
Light color infinitely variable



Integrierter Dimmer ·
Integrated dimmer



07 | Nickel matt · nickel mat



32 | Schwarz matt · black mat



Deckenleuchte · Ceiling lamp

Ø 50 cm, ↑ 5,2 cm
incl. SMD-LED, 44 W
5.300 lm, 3.000 K
incl. SMD-LED, 20 W
2.000 lm, 2.700 - 6.500 K



626910307
626910332



Deckenleuchte · Ceiling lamp

Ø 70 cm, ↑ 5,8 cm
incl. SMD-LED, 70 W
8.400 lm, 3.000 K
incl. SMD-LED, 25 W
2.500 lm, 2.700 - 6.500 K



626919307
626919332



3.000 K



5.500 K

OSAKA

Chrom, Acryl, Starlight-Effekt · chrome, acryl, starlight effect ·
 chrome, acryl, effet étoile · chrom, acryl, sterlicht effect · cromo, acrílico, efecto de la luz · cromo, acrilico, effetto di stelle ·
 crom, acrilic, efect lumina stelelor · kromi, akryyli, starlight vaikutus · chrom, akryl, efekt starlight



Deckenleuchte · Ceiling lamp
 Ø 21 cm, ↑ 5 cm
 incl. SMD-LED, max. 12 W
 max. 1.160 lm, 3.000 K



678711206



Deckenleuchte · Ceiling lamp
 Ø 42 cm, ↑ 7 cm
 incl. SMD-LED, max. 27 W
 max. 3.100 lm, 3.000 - 5.500 K



678713006



Deckenleuchte · Ceiling lamp
 Ø 65 cm, ↑ 10 cm
 incl. SMD-LED, max. 91,5 W
 max. 11.000 lm, 3.000 - 5.500 K



678710006



MIKO

Chrom, Acryl, Starlight-Effekt · chrome, acryl, starlight effect ·
 chrome, acryl, effet étoile · chroom, acryl, sterlicht effect · cromo, acrílico, efecto de la luz ·
 cromo, acrílico, effetto di stelle · crom, acrilic, efect lumina stelelor · kromi, akryyli, starlight vaikutus ·
 chrom, akryl, efekst starlight · krom, akrilik, starlight etkisi



Lichtfarbe stufenlos einstellbar ·
 Light color infinitely variable



Integrierter Dimmer ·
 Integrated dimmer



Memory Funktion ·
 Memory function



3.000 K

5.500 K

Deckenleuchte · Ceiling lamp

Ø 85 cm, ↑ 12,5 cm
 incl. SMD-LED, 90 W
 10.800 lm, 3.000 - 5.500 K



675610106



SEIKO

Acryl, Starlight-Effekt · acryl, starlight effect ·
 acryl, effet étoile · acryl, sterlicht effect ·
 acrílico, efecto de la luz · acrílico, effetto di stelle ·
 acrílic, efect lumina stelelor · akryyli, starlight vaikutus ·
 akryl, efekt starlight



Lichtfarbe stufenlos einstellbar ·
 Light color infinitely variable



Integrierter Dimmer ·
 Integrated dimmer



Memory Funktion ·
 Memory function



Deckenleuchte · Ceiling lamp
 Ø 42,5 cm, ↑ 6 cm
 incl. SMD-LED, 21,5 W
 2.400 lm, 3.000-5.500 K



678513001



TOKYO

Acryl · acryl ·
acryl · acryl · acrílico · acrilico · acrilic · akryyli · akryl



Lichtfarbe stufenlos einstellbar ·
Light color infinitely variable



Memory Funktion ·
Memory function



Deckenleuchte · Ceiling lamp
Ø 60 cm, ↑ 6,5 cm
incl. SMD-LED, 43 W
4.000 lm, 3.000 - 5.500 K



628915001

SHOGUN

Acryl, Starlight-Effekt · acryl, starlight effect ·
acryl, effet étoile · acryl, sterlicht effect ·
acrílico, efecto de la luz · acrilico, effetto di stelle ·
acrilic, efect lumina stelelor · akryyli, starlight vaikutus ·
akryl, efekt starlight



Lichtfarbe stufenlos einstellbar ·
Light color infinitely variable



Integrierter Dimmer ·
Integrated dimmer



Memory Funktion ·
Memory function

Deckenleuchte · Ceiling lamp

Ø 42,5 cm, ↓ 6 cm
incl. SMD-LED, 21,5 W
2.400 lm, 3.000-5.500 K



628513001

328



SAMURAI

Acryl, Starlight-Effekt · acryl, starlight effect ·
acryl, effet étoile · acryl, sterlicht effect ·
acrílico, efecto de la luz · acrilico, effetto di stelle ·
acrilic, efect lumina stelelor · akryyli, starlight vaikutus ·
akryl, efekt starlight



Lichtfarbe stufenlos einstellbar ·
Light color infinitely variable



Integrierter Dimmer ·
Integrated dimmer



Memory Funktion ·
Memory function

Deckenleuchte · Ceiling lamp

↔ 42,5 x 42,5 cm, ↓ 6 cm
incl. SMD-LED, 21,5 W
2.400 lm, 3.000-5.500 K



628613001





NAGANO

Acryl, Starlight-Effekt · acryl, starlight effect ·
 acryl, effet étoile · acryl, sterlicht effect · acrílico, efecto de la luz ·
 acrilico, effetto di stelle · acrilic, efect lumina stelelor · akryyli, starlight vaikutus · akryl, efekt starlight



Lichtfarbe stufenlos einstellbar ·
 Light color infinitely variable



Integrierter Dimmer ·
 Integrated dimmer



Memory Funktion ·
 Memory function



3.000 K

5.500 K

Deckenleuchte · Ceiling lamp
 Ø 80 cm, ↑ 10,8 cm
 incl. SMD-LED, max. 72 W
 max. 8.500 lm, 3.000 - 5.500 K



677718000



LUNAR

Kunststoff · plastic ·
plastique · kunststof · plástico · plastica · plastic · muovi · plastik · plastik

Mondphasen individuell einstellbar · Phases of the moon individually adjustable ·
Phases de lune réglables · Maanstanden apart instelbaar ·
Fases lunares ajustables individualmente · Fasi lunari regolabili individualmente ·
Fazele lunii reglabile individual · Kuun vaiheet erikseen säädettävissä ·
Cykl księżyca indywidualnie regulowany



Musterschutz ·
Registered model



Integrierter Dimmer ·
Integrated dimmer



Deckenleuchte · Ceiling lamp
Ø 40 cm, ↑ 10 cm
incl. SMD-LED, 22 W
2.460 lm, 3.000 K



627514000



Deckenleuchte · Ceiling lamp
Ø 60 cm, ↑ 12 cm
incl. SMD-LED, 40 W
3.500 lm, 3.000 K





627516000



NORIAKI

Chrom, Acryl, Starlight-Effekt · chrome, acryl, starlight effect ·
 chrome, acryl, effet étoile · chroom, acryl, sterlicht effect ·
 cromo, acrílico, efecto de la luz · cromo, acrilico, effetto di stelle ·
 crom, acrilic, efect lumina stelelor · kromi, akryyli, starlight vaikutus ·
 chrom, akryl, efekt starlight

 Lichtfarbe stufenlos einstellbar ·
 Light color infinitely variable

 Integrierter Dimmer ·
 Integrated dimmer

 Memory Funktion ·
 Memory function

 Getrennt schaltbar ·
 Separately switchable



3.000 K

5.500 K



Deckenleuchte · Ceiling lamp
 Ø 59,5 cm, ↑ 10 cm
 incl. SMD-LED, 40 W
 4.750 lm, 3.000-5.500 K



679210106



GONZALO

Kunststoff, Weiß oder titanfarbig · plastic, white or titan ·
 plastique, blanc ou titane · kunststof, wit of titaan · plástico, blanco o titán ·
 plastica, bianco o titano · plastic, alb sau titaniu · muovi, valkoinen tai titaani ·
 plastik, biały lub tytanowy



Dimmbar ·
Dimmable



Deckenleuchte · Ceiling lamp
 Ø 29 cm, ↓ 8 cm
 incl. SMD-LED, 9 W
 900 lm, 3.000 K



626510987



Deckenleuchte · Ceiling lamp
 Ø 34 cm, ↓ 9 cm
 incl. SMD-LED, 12 W
 1.050 lm, 3.000 K



626511287



Deckenleuchte · Ceiling lamp
 Ø 42 cm, ↓ 10 cm
 incl. SMD-LED, 25 W
 2.300 lm, 3.000 K



626512587



CESAR

Chrom, Acryl mit Kristalleffekt · chrome, broken glass optic ·
 chrome, optique verre pilé · chroom, Gebroken glas optiek · cromo, Efecto cristal roto ·
 cromo, effetto ottico vetro rotto · crom, aspect de sticla sparta · kromi, lasi efekti optiikka · chrom, Optyczne rozbite szkło

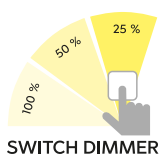

SWITCH DIMMER



Deckenleuchte · Ceiling lamp
 Ø 26 cm, ↑ 3 cm
 incl. SMD-LED, 13 W
 1.500 lm, 3.000 K



656411506



Deckenleuchte · Ceiling lamp
 Ø 40 cm, ↑ 3 cm
 incl. SMD-LED, 22 W
 2.700 lm, 3.000 K



656412406



Deckenleuchte · Ceiling lamp
 ↔ 30 x 30 cm, ↑ 3 cm
 incl. SMD-LED, 16 W
 1.900 lm, 3.000 K



656511806



Deckenleuchte · Ceiling lamp
 ↔ 40 x 40 cm, ↑ 3 cm
 incl. SMD-LED, 22 W
 2.700 lm, 3.000 K



656512006



FERNANDO

Metall, Weiß matt oder Schwarz matt · metal, white mat or black mat ·
 metals, blanc mat ou noir mat · metaal, wit mat of mat zwart ·
 metal, estera blanca o estera negra · metallo, bianco opaco o nero opaco ·
 metal, alb mat sau negru mat · metalli, valkoinen matto tai musta matto ·
 metal, biały mat lub czarny mat

Empfohlen:

recommended: LED GU10, 5 W
 400 lm, 3.000 K



956-5936



31 | Weiß matt · white mat



32 | Schwarz matt · black mat



Deckenleuchte · Ceiling lamp

↔ 23 x 20 cm, ↑ 15 cm
 excl. 3 x GU10, max. 35 W

604900331
604900332



Deckenleuchte · Ceiling lamp

↔ 37 x 30 cm, ↑ 15 cm
 excl. 6 x GU10, max. 35 W



604900631
604900632





31 | Weiß matt · white mat



32 | Schwarz matt · black mat



34 | Schwarz-Weiß · black-white



80 | Schwarz-Gold · black-gold



COOKIE

Metall, Weiß matt oder Schwarz matt · metal, white mat or black mat ·
 metale, blanc mat ou noir mat · metaal, wit mat of mat zwart · metal, estera blanca o estera negra · metallo, bianco opaco o nero opaco ·
 metal, alb mat sau negru mat · metalli, valkoinen matto tai musta matto · metal, biały mat lub czarny mat



Deckenleuchte · Ceiling lamp
 Ø 9,6 cm, ↓ 12,5 cm
 excl. 1 x GU10, max. 35 W



612900131
 612900132
 612900134
 612900180



Deckenleuchte · Ceiling lamp
 ↔ 17,8 x 9,6 cm, ↓ 12,5 cm
 excl. 2 x GU10, max. 35 W



612900231
 612900232



Deckenleuchte · Ceiling lamp
 ↔ 17,8 x 17,8 cm, ↓ 12,5 cm
 excl. 4 x GU10, max. 35 W



612900431
 612900432

Empfohlen:

recommended: LED GU10, 5 W
 400 lm, 3.000 K



956-5936



31 | Weiß matt · white mat



32 | Schwarz matt · black mat



34 | Schwarz-Weiß · black-white



80 | Schwarz-Gold · black-gold

BISCUIT

Metall, Weiß matt oder Schwarz matt · metal, white mat or black mat ·
 metale, blanc mat ou noir mat · metaal, wit mat of mat zwart · metal, estera blanca o estera negra · metallo, bianco opaco o nero opaco ·
 metal, alb mat sau negru mat · metalli, valkoinen matto tai musta matto · metal, biały mat lub czarny mat



Deckenleuchte · Ceiling lamp
 ↔ 9,6 x 9,6 cm, ↓ 12,5 cm
 excl. 1 x GU10, max. 35 W



613000131
 613000132
 613000134
 613000180



Deckenleuchte · Ceiling lamp
 ↔ 17,8 x 9,6 cm, ↓ 12,5 cm
 excl. 2 x GU10, max. 35 W



613000231
 613000232



Deckenleuchte · Ceiling lamp
 ↔ 17,8 x 17,8 cm, ↓ 12,5 cm
 excl. 4 x GU10, max. 35 W



613000431
 613000432

Empfohlen:

recommended: LED GU10, 5 W
 400 lm, 3.000 K



956-5936



QUINTA

rostfarbig, Glas alabasterfarbig · rusty, alabaster-coloured glass ·
 rouille, verre couleur albâtre · roestkleur, albastkleurig glas · óxido, vidrio de color alabastro ·
 ruggine, vetro colore alabastro · ruginiu, sticla culoare alabastru · rustiikki, lasi alabasteri väri · miedź, szkło alabaster kolor



Deckenleuchte · Ceiling lamp
 Ø 33 cm, ↓ 20 cm
 excl. 2 x E27, max. 42 W



608100224



Deckenleuchte · Ceiling lamp
 Ø 42 cm, ↓ 32 cm
 excl. 3 x E27, max. 60 W



608100324



Empfohlen:
recommended: Filament-LED E27, 4 W
470 lm, 2.700 K



987-400

JOHANN

Metall, Schwarz matt, Grau antik oder Kupfer antik · metal, black mat, antique grey or antique copper ·
métal, noir mat, gris ancien ou cuivre ancien · metaal, mat zwart, antiek grijs of antiek koper · metal, estera negra, gris antiguo
o cobre antiguo · metallo, nero opaco, grigio antico o rame antico · metal, negru mat, antic gri sau cupru antic ·
metalli, mattamusta, antiikki harmaa tai antiikki kupari · metal, czarny mat, starodawny szary lub antyczne miedzi



32 | Schwarz matt ·
black mat



61 | Grau antik ·
antique grey



62 | Kupfer antik ·
antique copper



Deckenleuchte · Ceiling lamp
Ø 30 cm, ↑ 18 cm
excl. 1 x E27, max. 60 W



606903032



Deckenleuchte · Ceiling lamp
Ø 40 cm, ↑ 17 cm
excl. 1 x E27, max. 60 W



606900132
606900161
606900162



Deckenleuchte · Ceiling lamp
Ø 50 cm, ↑ 18 cm
excl. 1 x E27, max. 60 W



606905032



PALI

Holz, Glas satiniert · wood, satinated glass ·
 bois, Verre satiné · hout, Gesatineerd glas · maderas, Vidrio satinado ·
 di legno, Vetro satinato · lemn, Sticla satinata · puu, Satinoitu lasi ·
 drewno, Szkło satynowe



30 | Holz naturbelassen · wood natural finish



56 | Holz dunkel · old wood



Wandleuchte · Wall lamp
 ↓ 25 x 25 cm, ↗ 9 cm
 excl. 1 x E27, max. 40 W



212600130
 212600156



Wandleuchte · Wall lamp
 ↓ 45 x 14 cm, ↗ 10,5 cm
 excl. 2 x E27, max. 40 W



212600230
 212600256



Deckenleuchte · Ceiling lamp
 Ø 32 cm, ↓ 9 cm
 excl. 2 x E27, max. 25 W



612600230
 612600256



LANA

Glas Weiß matt oder alabasterfarbig · glass white mat or alabaster · coloured · verre blanc mat ou couleur albâtre · glas wit mat of albastkleurig · vidrio estera blanca o Color alabastro · vetro bianco opaco o color alabastro · sticla alb mat sau Colorat în alabastru · lasi mattavalkoinen tai alabasterin värinen · szkło biały mat lub kolor alabastrowy



07



01

344

Deckenleuchte · Ceiling lamp Deckenleuchte · Ceiling lamp
Ø 25 cm, ↑ 9 cm Ø 25 cm, ↑ 9 cm
excl. 1 x E27, max. 40 W excl. 1 x E27, max. 40 W



6196011-01



6196011-07

PRIMO

Metall, Glas · metal, glass ·
metale, verre · metaal, glas · metal, vidrio · metallo, vetro ·
metal, sticla · metalli, lasi · metal, szkło



01 | Weiß · white



07 | Nickel matt · nickel mat



Deckenleuchte · Ceiling lamp
Ø 30 cm, ↑ 7,5 cm
excl. 1 x E27, max. 60 W



6101011-01
6101011-07





ADRIAN

Glas alabasterfarbig · alabaster-coloured glass ·
 verre couleur albâtre · albastkleurig glas · vidrio de color alabastro ·
 vetro colore alabastro · sticla culoare alabastru · lasi alabasteri väri ·
 szkło alabaster kolor



Deckenleuchte · Ceiling lamp
 Ø 30 cm, ↓ 9 cm
 excl. 1 x E27, max. 40 W



6105011-01



Deckenleuchte · Ceiling lamp
 Ø 40 cm, ↓ 10 cm
 excl. 2 x E27, max. 40 W



6105021-01

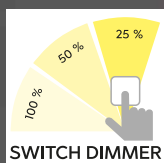

SWITCH DIMMER

RAVEN

Schiefer, Schwarz · Shale, black ·
 Ardoise, noir · Leisteen, zwart · Pizarra, negro ·
 Ardesia, nero · Ardezie, negru · Savi, musta · łupek, czarny



Wandleuchte · Wall lamp
 Ø 20 cm, ↗ 3,6 cm
 incl. SMD-LED, 9 W
 1.000 lm, 3.000 K



224290102



Wandleuchte · Wall lamp
 ↔ 25 x 12 cm, ↗ 3,6 cm
 incl. SMD-LED, 9 W
 1.000 lm, 3.000 K



224210102

CONCHA

rostfarbig, Weiß matt oder Anthrazit · rusty, white mat or anthracite ·
 rouille, blanc mat ou antracite · roestkleur, wit mat of antraciet · óxido, estera blanca o antracita ·
 ruggine, bianco opaco o antracite · ruginiu, alb mat sau antracit · rustiikki, mattavalkoinen tai antrasiitti ·
 miedź, biały mat lub antracyt

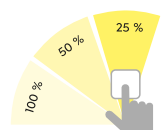

SWITCH DIMMER



24 | rostfarbig · rusty

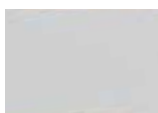

31 | Weiß matt · white mat

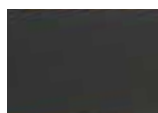

42 | Anthrazit · anthracite



Wandleuchte · Wall lamp
 ↔ 28 x 8 cm, √ 4,5 cm
 incl. 2 x SMD-LED, 6 W
 2 x 600 lm, 3.000 K



225172924
 225172931
 225172942



Wandleuchte · Wall lamp
 ↔ 47 x 8 cm, √ 4,5 cm
 incl. 2 x SMD-LED, 9 W
 2 x 1.000 lm, 3.000 K



225174724
 225174731
 225174742

MIGUEL

Metall, Weiß matt oder Schwarz matt · metal, white mat or black mat · metale, blanc mat ou noir mat · metaal, wit mat of mat zwart · metal, estera blanca o estera negra · metallo, bianco opaco o nero opaco · metal, alb mat sau negru mat · metalli, valkoinen matto tai musta matto · metal, biały mat lub czarny mat

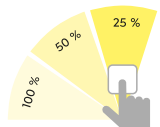

SWITCH DIMMER



348

Wandleuchte · Wall lamp

↔ 20,5 x 16,5 cm, ↗ 8,3 cm
incl. SMD-LED, 2 x 6 W
2 x 600 lm, 3.000 K



224910231 | Weiß matt · white mat

224910232 | Schwarz matt · black mat



LOUIS

Metall · metal · metale · metaal · metallo · metal · metalli · metal · metal

05



31



Wandleuchte · Wall lamp

↑ 10 x 10 cm, ↗ 10 cm
incl. 1 x OSRAM-LED, 4,3 W
430 lm, 3.000 K



223310105 | Aluminium gebürstet · brushed aluminium

223310131 | Weiß matt · white mat

223310132 | Schwarz matt · black mat



LACAPO

Metall · metal ·
metale · metaal · metallo · metal · metalli · metal



Wandleuchte · Wall lamp
↔ 10,5 cm, ↑ 6 cm, ↗ 15 cm
incl. SMD-LED, 4,3 W
430 lm, 3.000 K



223410131 | Weiß matt · white mat
223410132 | Schwarz matt · black mat

WALES

Nickel matt · nickel mat ·
nickel mat · nikkel mat · níquel mate ·
nichel opaco · nichel mat · harjattu teräs · nikiel mat



350

Wandleuchte · Wall lamp

↔ 9 cm, ↑ 9 cm, ↗ 5,8 cm
incl. 2 x SMD-LED, 3,1 W
2 x 310 lm, 3.000 K



225510207



PLATON

Aluminium gebürstet, Acryl · brushed aluminium, acryl ·
aluminium balayé, acryl · geborsteld aluminium, acryl ·
aluminio pulido, acrílico · alluminio spazzolato, acrilico ·
aluminium lucios, acrilic · harjattu alumiini, akryyli ·
aluminium szczotkowane, akryl



Wandleuchte · Wall lamp

↔ 13 x 18 cm, ↗ 9 cm
incl. 1 x SMD-LED, 4,3 W
430 lm, 3.000 K



274670105



Wandleuchte · Wall lamp

↔ 30 x 18 cm, ↗ 11 cm
incl. 2 x SMD-LED, 4,3 W
2 x 430 lm, 3.000 K



274670205





ADRIANO

Aluminium gebürstet oder Weiß · brushed aluminium or white ·
 aluminium balayé ou blanc · geborsteld aluminium of wit ·
 aluminio pulido o blanco · alluminio spazzolato o bianco ·
 aluminiu lucios sau alb · harjattu alumiini tai valkoinen ·
 aluminium szczotkowane lub biały



01 | Weiß · white



05 | Aluminium gebürstet · brushed aluminium

Wandleuchte · Wall lamp
 ↔ 30 x 6 cm, √ 8 cm
 incl. 2 x SMD-LED, 3,1 W
 2 x 310 lm, 3.000 K



220810201
 220810205



Wandleuchte · Wall lamp

↔ 12 x 12 cm, ↗ 10 cm
incl. SMD-LED, 4,3 W
430 lm, 3.000 K



224810132
224810167



352

ARINO

Metall, Holz · metal, wood ·
metale, bois · metaal, hout · metal, madera ·
metallo, di legno · metal, lemn · metalli, puu ·
metal, drewno

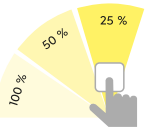

SWITCH DIMMER



32 | Schwarz matt · black matt

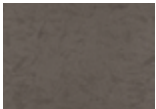

67 | Nickel antik · nickel antique



Wandleuchte · Wall lamp

↔ 35,2 x 12 cm, ↗ 10 cm
incl. SMD-LED, 13,5 W
1.500 lm, 3.000 K



224819132
224819167



CLEO

Metall, goldfarbig · metal, gold ·
metale, or · metaal, goud · metal, oro · metallo, oro ·
metal, aur · metalli, kultaa · metal, złota



Up and down Beleuchtung ·
Up and down lighting

Empfohlen:

recommended: LED GU10, 4,5 W
345 lm, 3.000 K



956-55



Wandleuchte · Wall lamp
↓ 15 x 8 cm, ↗ 8 cm
excl. 2 x GU10, max. 35 W



206500279



Wandleuchte · Wall lamp
↓ 16,5 x 6 cm, ↗ 10 cm
excl. 2 x GU10, max. 35 W



206400279



CHIROS

Metall, goldfarbig, Glas satiniert · metal, gold, satinated glass ·
 metale, or, verre satiné · metaal, goud, gesatineerd glas · metal, oro, vidrio satinado ·
 metallo, oro, vetro satinato · metal, aur, sticla satinata · metalli, kultaa, satinoitu lasi ·
 metal, złota, szkło satynowe



Wandleuchte · Wall lamp
 Ø 22 cm, ʘ 6,5 cm
 incl. 1 x SMD-LED, 8 W
 800 lm, 3.000 K



224110179



Deckenleuchte · Ceiling lamp
 Ø 32 cm, ʘ 6 cm
 incl. 1 x SMD-LED, 12 W, 1.280 lm
 incl. 1 x SMD-LED, 3,5 W, 350 lm
 3.000 K

624110279



MARRIOT

Nickel matt oder goldfarbig, Stoffschirm · nickel mat or gold, fabric shade ·
 nickel mat ou or, abat-jour tissu · nikkel mat of goud, Stoffen kap · níquel mate o oro, Pantalla de tela ·
 nichel opaco o oro, paralume in tessuto · nichel mat sau aur, abajur textil ·
 harjattu teräs tai kultaa, kangas varjostin · nikiel mat lub złota, Klosz z materiału

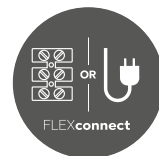

Seite/page 580



07 | Nickel matt · nickel mat



79 | goldfarbig · gold



Getrennt schaltbar ·
 Separately switchable

Wandleuchte · Wall lamp
 † 30,8 x 14 cm, ∅ 17,6 cm
 incl. 1 x SMD-LED, 3,1 W
 310 lm, 3.000 K
 excl. 1 x E14, max. 40 W



271470207
 271470279

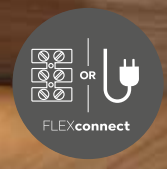
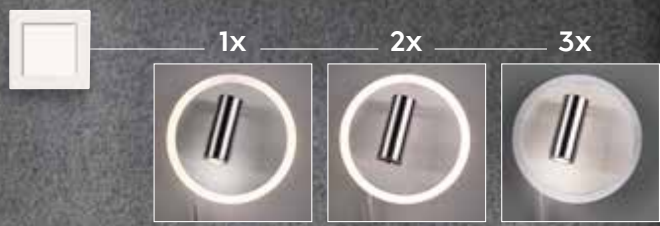

Seite/page 580

JORDAN

Nickel matt, Weiß matt oder Schwarz matt, Acryl · nickel mat, white mat or black mat, acryl ·
 nickel mat, blanc mat ou noir mat, acryl · nikkel mat, wit mat of mat zwart, acryl ·
 níquel mate, estera blanca o estera negra, acrílico · nichel opaco, bianco opaco o nero opaco, acrílico ·
 nichel mat, alb mat sau negru mat, acrilic · harjattu teräs, mattavalkoinen tai mattamusta, akryyli ·
 nikiel mat, biały mat lub czarny mat, akryl

Getrennt schaltbar · Separately switchable



07 | Nickel matt · nickel mat



31 | Weiß matt · white mat



32 | Schwarz matt · black mat

Wandleuchte · Wall lamp
 Ø 15 cm, 12 cm
 incl. 1 x SMD-LED, 5 W
 550 lm, 3.000 K
 incl. 1 x SMD-LED, 2 W
 200 lm, 3.000 K



229210207
 229210231
 229210232



MARIO

Metall, Weiß matt oder Schwarz matt · metal, white mat or black mat ·
 metale, blanc mat ou noir mat · metaal, wit mat of mat zwart ·
 metal, estera blanca o estera negra · metallo, bianco opaco o nero
 opaco · metal, alb mat sau negru mat · metalli, valkoinen matto
 tai musta matto · metal, biały mat lub czarny mat



Getrennt schaltbar ·
 Separately switchable



31 | Weiß matt · white mat



32 | Schwarz matt · black mat

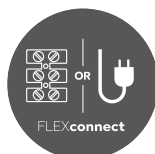

Seite/page 580



Wandleuchte · Wall lamp

Ø 16 cm, ⚓ 10,5 cm
 incl. 1 x SMD-LED, 6 W
 600 lm, 3.000 K
 incl. 1 x SMD-LED, 2,3 W
 200 lm, 3.000 K





222370231
222370232



ELEMENT

Metall, Weiß matt oder Schwarz matt · metal, white mat or black mat ·
 metallo, bianco opaco o nero opaco · metal, alb mat sau negru mat ·
 metalli, valkoinen matto tai musta matto · metal, biały mat lub czarny mat

 USB Anschluss mit Ladefunktion ·
 Recharging USB connection

 Getrennt schaltbar ·
 Separately switchable

 indirekte Beleuchtung ·
 indirect lighting

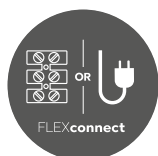

Seite/page 580



Wandleuchte · Wall lamp

↓ 20 x 16 cm, ∅ 14 cm
 incl. 1 x SMD-LED, 3 W
 220 lm, 3.000 K
 incl. 2 x SMD, 1,5 W
 2 x 150 lm, 3.000 K



222570231 | Weiß matt · white mat

222570232 | Schwarz matt · black mat



CUADRO

Altmessing oder Nickel matt · old brass or nickel mat ·
 laiton fumé ou nickel mat · oud brons of nikkel mat · bronce viejo o níquel mate ·
 ottone invecchiato o nichel opaco · bronz antic sau nichel mat ·
 antiikkimessinki tai harjattu teräs · patyna lub nikiel mat

Wandleuchte · Wall lamp

↔ 48 x 10,5 cm, ∅ 10 cm
 incl. 1 x SMD-LED, 8 W
 900 lm, 3.000 K



225210104 | Altmessing · old brass
 225210107 | Nickel matt · nickel mat

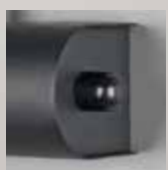

CURTIS

Altmessing, Nickel matt, Messing matt oder Schwarz matt · old brass, nickel mat, brass mat or black mat ·
 Laiton fumé, Nickel mat, Laiton mat ou Noir mat · Oud brons, Nikkel mat, Messing mat of Mat zwart ·
 Bronce viejo, Níquel mate, Bronce mate o Estera negra · Ottone invecchiato, Nichel opaco, Ottone satinato o Nero opaco ·
 Bronz antic, Nichel mat, Bronz mat sau Negru mat · Antiikkimessinki, Harjattu teräs, Mattamessinki tai mattamusta ·
 Patyna, Nikiel mat, Mosiądz mat lub Czarny mat

 Integrierter Dimmer ·
 Integrated dimmer

04 | Altmessing ·
 old brass



07 | Nickel matt ·
 nickel mat





08 | Messing matt ·
 brass mat



32 | Schwarz matt ·
 black mat



Wandleuchte · Wall lamp
 ↔ 18 cm, ↗ max. 35 cm
 incl. SMD-LED, 4 W
 430 lm, 3.000 K

 
 279770104
 279770107
 279770108
 279770132

BALDO

Metall, schwarz matt · metal, black mat ·
metale, noir mat · metaal, mat zwart · metal, estera negra ·
metallo, nero opaco · metal, negru mat ·
metalli, mattamusta · metal, czarny mat

Empfohlen:

recommended: Filament LED E27, 7 W
806 lm, 2.700 K



987-6810



362

Wandleuchte · Wall lamp

↔ 28 cm, ↑ 28,3 cm, ↗ max. 150 cm,
excl. 1 x E27, max. 40 W



200600132

LINE

Metall, schwarz matt · metal, black mat ·
metale, noir mat · metaal, mat zwart · metal, estera negra ·
metallo, nero opaco · metal, negru mat ·
metalli, mattamusta · metal, czarny mat

Empfohlen:

recommended: Filament LED E27, 7 W
806 lm, 3.000 K



988-600



Wandleuchte · Wall lamp

↔ 5,5 cm, ↑ 25 cm, ↗ max. 150 cm
excl. 1 x E27, max. 10 W



200200132



BOLDER

Metall, schwarz matt · metal, black mat ·
 metale, noir mat · metaal, mat zwart · metal, estera negra ·
 metallo, nero opaco · metal, negru mat · metalli, mattamusta ·
 metal, czarny mat

Empfohlen:
 recommended: Filament LED E27, 8 W
 806 lm, 2.700 K



985-6810

Wandleuchte · Wall lamp
 ↔ 35 cm, ↓ 29 cm, ↗ max. 150 cm
 excl. 1 x E27, max. 40 W



200300132

CAMPO

rostfarbig, Scavo glas · rusty, scavo glass ·
rouille, verre scavo · roestkleur, scavo glas ·
óxido, vidrio scavo · ruggine, vetro scavo ·
ruginiu, sticla scavo · rustiikki, scavo-lasi ·
miedz, szkło scavo

Empfohlen:

recommended: Filament LED E14, 4 W
470 lm, 2.700 K



989-400

364

Wandleuchte · Wall lamp

↑ 44 cm, ↔ 12 cm, ↗ 16 cm
excl. 1 x E14, max. 40 W



200970124



DIVO

Chrom, Glas · chrome, glass ·
chrome, verre · chroom, glas · cromo, vidrio ·
cromo, vetro · crom, sticla · kromi, lasi · chrom, szkło

Empfohlen:

recommended: LED E14, 3,5 W
320 lm, 3.000 K



989-40



Wandleuchte · Wall lamp

↔ 20 x 20 cm, ↗ 7,5 cm
excl. 1 x E14, max. 40 W



2522011-06

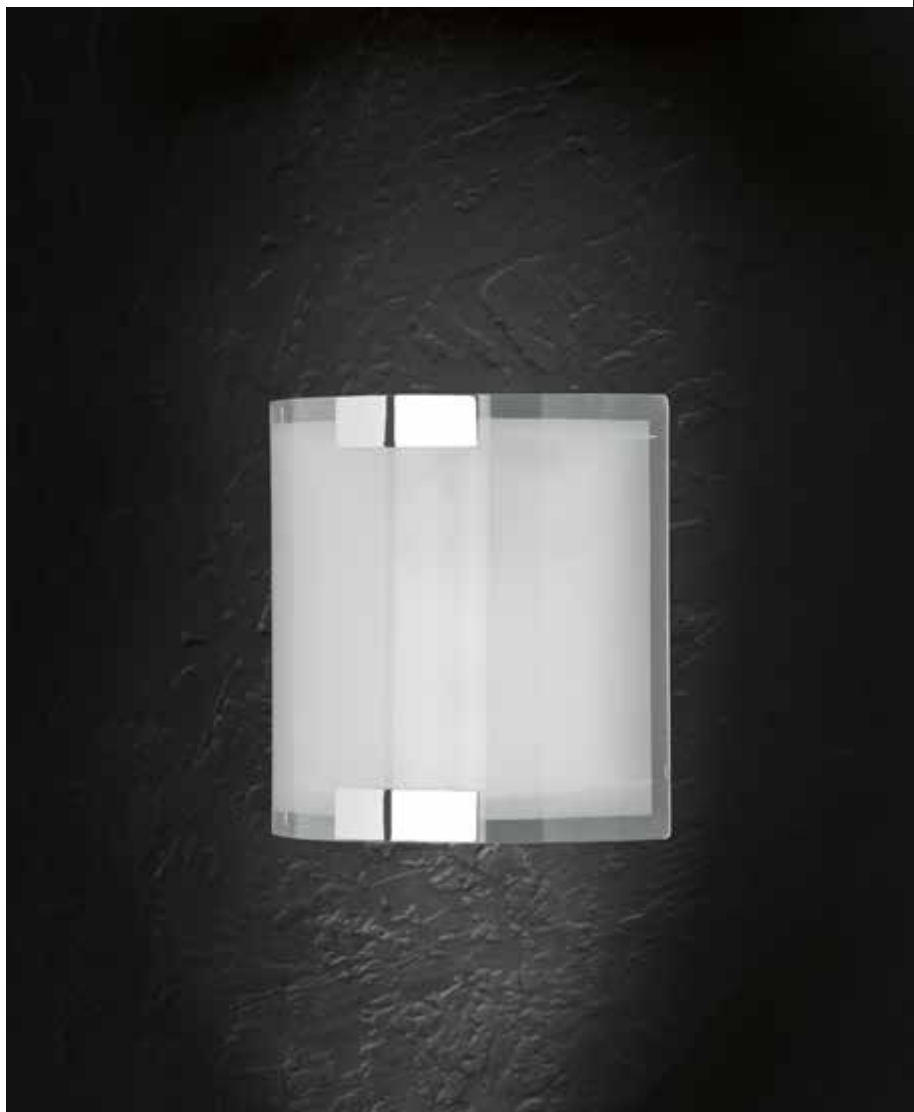



PURA

Metall, Glas · metal, glass ·
 metale, verre · metaal, glas · metal, vidrio ·
 metallo, vetro · metal, sticla · metalli, lasi · metal, szkło

Empfohlen:
 recommended: Filament LED E27, 7 W
 806 lm, 2.700 K



987-6810



04 | Altmessing · old brass



07 | Nickel matt · nickel mat



Wandleuchte · Wall lamp
 ↑ 20 cm, ↔ 20 cm, ∠ 7,5 cm
 excl. 1 x E27, max. 40 W



212700104
212700107



Wandleuchte · Wall lamp
 ↑ 40 cm, ↔ 20 cm, ∠ 7,5 cm
 excl. 2 x E27, max. 25 W



212700204
212700207

LILLY

Empfohlen:

recommended: Filament LED E27, 7 W
680 lm, 2.700 K



988-710



Deckenleuchte · Ceiling lamp

Ø 30 cm, ↓ 6 cm
excl. 1 x E27, max. 40 W



603300101

Überstreichbare Gipsleuchten ·

Gypsum lights that can be painted · Lampes en gypse à peindre · overschilderbare gipslampen · Lámparas de yeso que pueden pintarse · Le lampade in gesso possono essere verniciate · Lāmpi de ipsos, ce pot fi vopsite · Maalattava kipsivalaisin · Oświetlenie gipsowe, które można pomalować

ZAZOU

Empfohlen:

recommended: LED GU10, 5 W
400 lm, 3.000 K



955-50



Wandleuchte · Wall lamp

↓ 16,5 cm, ↔ 7,5 cm, ↗ 7 cm
excl. 2 x GU10, max. 10 W



201100201





ROMA

Überstreichbare Gipsleuchte · Gypsum lights that can be painted ·
 Lampes en gypse à peindre · overschilderbare gipslampen ·
 Lámparas de yeso que pueden pintarse · Le lampade in gesso possono essere verniciate ·
 Lāmpi de ipsos, ce pot fi vopsite · Maalattava kipsivalaisin ·
 Oświetlenie gipsowe, które można pomalować

Empfohlen:
 recommended: LED E14, 4,9 W
 470 lm, 3.000 K



983-60



Wandleuchte · Wall lamp
 ↔ 24,5 x 9,5 cm, ∅ 12 cm
 excl. 1 x E14, max. 28 W



201000101



WANDA

Metall, Kunststoff · metal, plastic ·
 metale, plastique · metaal, kunststof ·
 metal, plástico · metallo, plastica ·
 metal, plastic · metalli, muovi ·
 metal, plastik

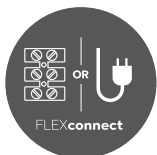

Seite/page 580



Wandleuchte · Wall lamp
 ↓ 23,5 cm, ↔ 8,5 cm, ↗ 22 cm
 excl. 1 x GU10, max. 10 W



202670107 | Nickel matt · nickel mat
 202670108 | Messing matt · brass mat
 202670131 | Weiß matt · white mat
 202670132 | Schwarz matt · black mat



Empfohlen:
recommended: LED GU10, 3 W
250 lm, 3.000 K



956-30

Klemmspot · clamp spot
↓ 20 cm, ↔ 7 cm, ↗ 22 cm
excl. 1 x GU10, max. 10 W



202620131 | Weiß matt · white mat
202620132 | Schwarz matt · black mat

LEVISTO

Glas alabasterfarbig · alabaster-coloured glass ·
verre couleur albâtre · albastkleurig glas ·
vidrio de color alabastro · vetro colore alabastro ·
sticla culoare alabastru · lasi alabasteri väri ·
szkło alabaster kolor

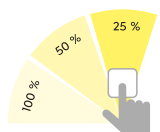

SWITCH DIMMER

Empfohlen:

recommended: LED E14, 4,9 W
470 lm, 3.000 K



983-66

370

Steckerleuchte · Plug light

↑ 40 cm, ↔ 4,7 cm, ∇ max. 22 cm
incl. 1 x LED E14, 28 W
470 lm, 3.000 K



891010107



LIGARA

Kunststoff · plastic ·
plastique · kunststof · plástico ·
plastica · plastic · muovi · plastik

Empfohlen:

recommended: LED E14, 3,5 W
320 lm, 3.000 K



983-40

Steckerleuchte · Plug light

↑ 28 cm, ↔ 6,9 cm, ∇ max. 20 cm
excl. 1 x E14, max. 40 W



8911211-07





ECCO

Nickel matt · nickel mat ·
 nickel mat · nikkell mat · níquel mate ·
 nichel opaco · nichel mat · harjattu teräs · nikiel mat

Unterbauleuchte · cabinet lighting

↔ 12,4 x 11,5 cm, ↓ 4,3 cm
 incl. 3 x SMD-LED, 3 W
 3 x 200 lm, 3.000 K



273370307 Set: 3 St./3 pc.





ARAGON

Kunststoff, Weiß oder titanfarbig · plastic, white or titan ·
 plastique, blanc ou titane · kunststof, wit of titaan · plástico, blanco o titán ·
 plastica, bianco o titano · plastic, alb sau titaniu · muovi, valkoinen tai titaani ·
 plastik, biały lub tytanowy



01 | Weiß · white



87 | titanfarbig · titanium-coloured



Unterbauleuchte · cabinet lighting

↔ 40 x 4 cm, ↓ 2 cm
 incl. 3 x SMD-LED, 1 W
 3 x 80 lm, 3.000 K



273170301
273170387



Unterbauleuchte · cabinet lighting

↔ 55 x 4 cm, ↓ 2 cm
 incl. 4 x SMD-LED, 1 W
 4 x 90 lm, 3.000 K



273170401
273170487



incl.

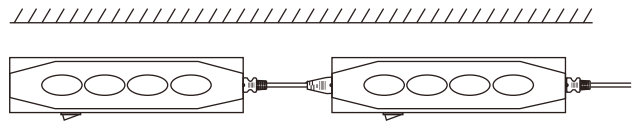
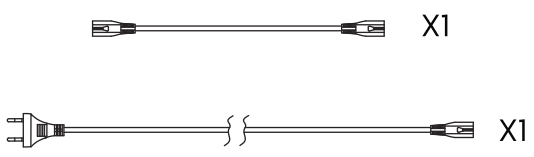



RAMON

Kunststoff · plastic ·
 plastique · kunststof · plástico ·
 plastica · plastic · muovi · plastik



Unterbauleuchte · cabinet lighting
 ↔ 28 x 2,5 cm, ↓ 4 cm
 incl. 1 x SMD-LED, 3,5 W
 400 lm, 3.000 K



273070401



Unterbauleuchte · cabinet lighting
 ↔ 51 x 2,5 cm, ↓ 4 cm
 incl. 1 x SMD-LED, 6,5 W
 700 lm, 3.000 K



273070701



Unterbauleuchte · cabinet lighting
 ↔ 84 x 2,5 cm, ↓ 4 cm
 incl. 1 x SMD-LED, 12 W
 1.400 lm, 3.000 K



273071301



Unterbauleuchte · cabinet lighting
 ↔ 114 x 2,5 cm, ↓ 4 cm
 incl. 1 x SMD-LED, 16,5 W
 1.850 lm, 3.000 K



273071801



ALINO

Kunststoff, Weiß oder titanfarbig · plastic, white or titan ·
 plastique, blanc ou titane · kunststof, wit of titaan · plástico, blanco o titán ·
 plastica, bianco o titano · plastic, alb sau titaniu · muovi, valkoinen tai titaani ·
 plastik, biały lub tytanowy



01 | Weiß · white



87 | titanfarbig · titanium-coloured



Unterbauleuchte · cabinet lighting

↔ 34 x 7 cm, ↓ 2 cm
 incl. SMD-LED, 4 W
 350 lm, 3.000 K



272970401
272970487



Unterbauleuchte · cabinet lighting

↔ 55 x 7 cm, ↓ 2 cm
 incl. SMD-LED, 7 W
 600 lm, 3.000 K



272970701
272970787





Tisch- & Stehleuchten

Table- & floor lamps
Lampes de table & lampadaires
Tafel- & vloerlampen
Sobremesas y lámparas de pie
Lampade da tavolo e piantane
Veioze si lampadare
Pöytä- & lattia
Stółowe i podłogowe



31 | Weiß matt / Schirm Grau · white mat / shade grey



41 | Schwarz matt / Schirm Taupe · black mat / shade taupe

MANSUR

Metall, Stoffschirm · metal, fabric shade ·
metale, abat-jour tissu · metaal, Stoffen kap · metal, Pantalla de tela ·
metallo, paralume in tessuto · metal, abajur textil ·
metalli, kangas varjostin · metal, Klosz z materiału

Stehleuchte · Floor lamp
↑ 210 cm, Ø cm, ↗ 200 cm
excl. 1 x E27, max. 40 W



419200131
419200141



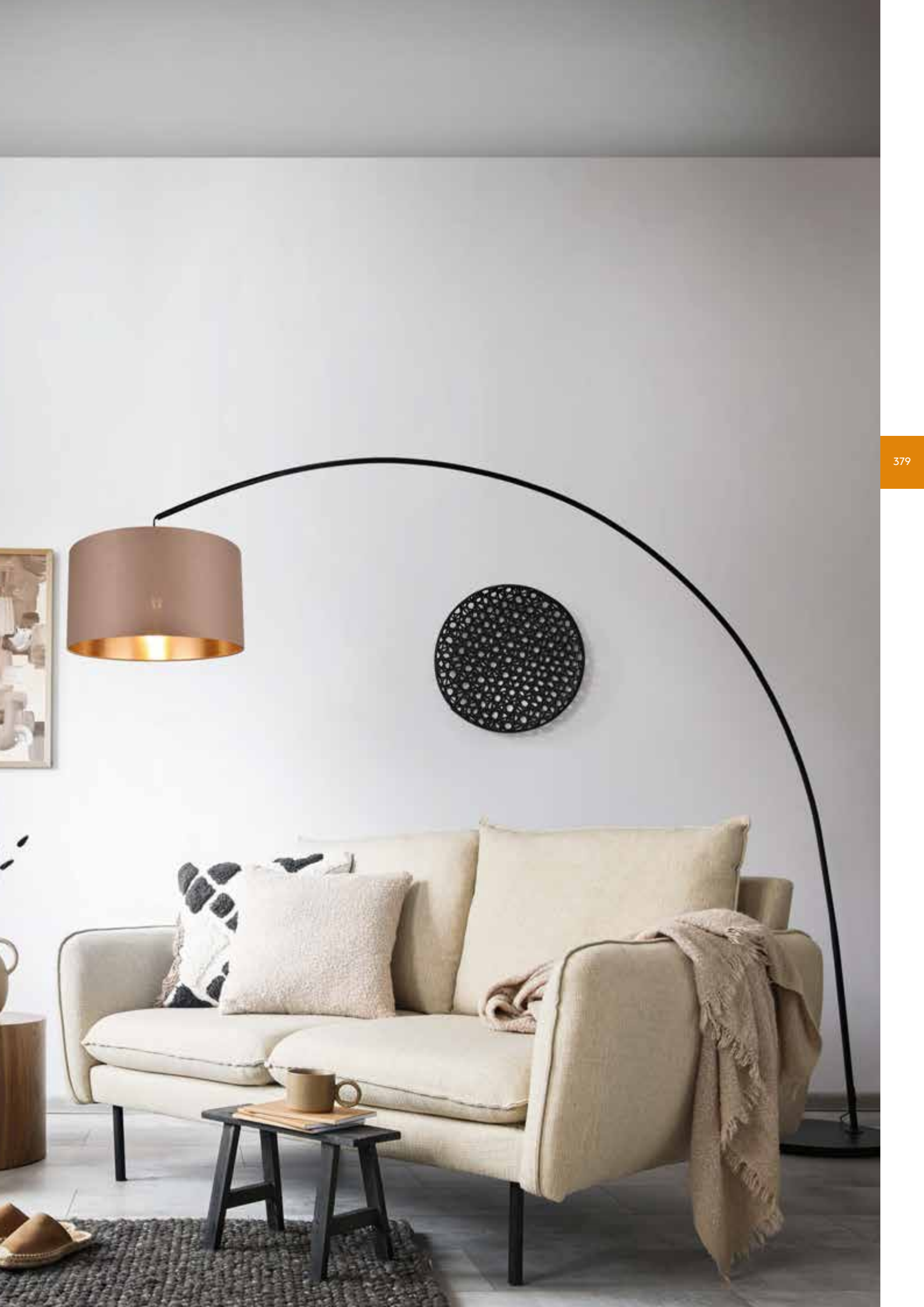



CLARK

Metall, Schwarz matt, Stoffschirm mehrfarbig · metal, black mat, fabric shade multicolor ·
 metale, noir mat, abat-jour tissu multicolore · metaal, mat zwart, Stoffen kap multicolor ·
 metal, estera negra, Pantalla de tela multicolor · metallo, nero opaco, paralume in
 tessuto multicolore · metal, negru mat, abajur textil multicolor · metalli, mattamusta,
 kangas varjostin monivärinen · metal, czarny mat, Klosz z materiału multi-kolor



Stehleuchte · Floor lamp
 ↓ 198 cm, ↔ 35 cm, ↗ 170 cm
 excl. 3 x E27, max. 60 W



401700317



TRACY

Metall, Schwarz matt, Stoffschirm · metal, black mat, fabric shade ·
 metale, noir mat, abat-jour tissu · metaal, mat zwart, Stoffen kap · metal, estera negra, Pantalla de tela ·
 metallo, nero opaco, paralume in tessuto · metal, negru mat, abajur textil · metalli, mattamusta, kangas varjostin ·
 metal, czarny mat, Klosz z materiału



Stehleuchte · Floor lamp
 † 175 cm, Ø 40 cm, √ max. 105 cm
 excl. 1 x E27, max. 60 W



462100132

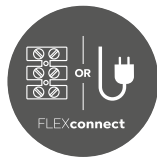

Seite/page 580



CASSIO

Metall, Stoff · metal, fabric ·
metale, tissu · metaal, textiel · metal, tela ·
metallo, tessuto · metal, textil · metalli, tekstiili · metal, tkanina



07 | Nickel matt · nickel mat



08 | Messing matt · brass mat



32 | Schwarz matt · black mat



Wandleuchte · Wall lamp
↑ 27,9 cm, Ø 23 cm, √ 25,9 cm
excl. 1 x E27, max. 40 W



214470107
214470108
214470132



Tischleuchte · Table lamp
↑ 48 cm, Ø 28 cm
excl. 1 x E27, max. 60 W



514400107
514400108
514400132



Stehleuchte · Floor lamp
↑ 153,3 cm, Ø 50 cm
excl. 1 x E27, max. 60 W



414400107
414400108
414400132



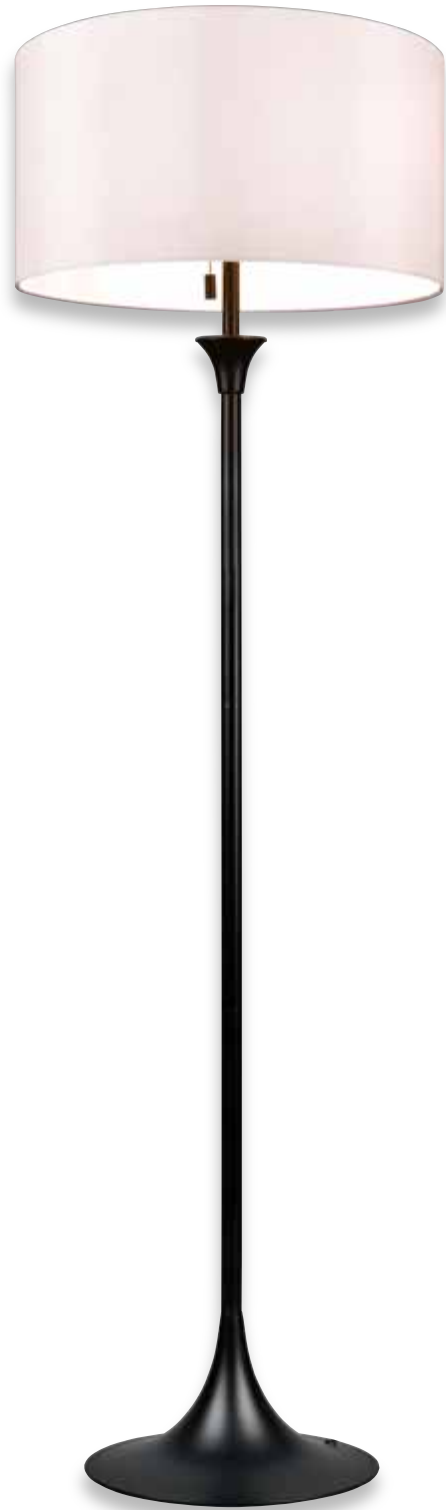

SABIA

Nickel matt oder Schwarz matt, Stoff · nickel mat or black mat, fabric ·
 nickel mat ou noir mat, tissu · nikkell mat of mat zwart, textiel ·
 níquel mate o estera negra, tela · nichel opaco o nero opaco, tessuto ·
 nichel mat sau negru mat, textil · harjattu teräs tai mattamusta, tekstiili ·
 nikiel mat lub czarny mat, tkanina



Tischleuchte · Table lamp
 ↑ 37 cm, Ø 20 cm
 excl. 1 x E27, max. 40 W



515790107
 515790132



Tischleuchte · Table lamp
 ↑ 62,5 cm, Ø 40 cm
 excl. 1 x E27, max. 60 W



515700107
 515700132



Stehleuchte · Floor lamp
 ↑ 155 cm, Ø 45,7 cm
 excl. 3 x E27, max. 40 W



415700307
 415700332





HOTEL

Metall, Stoffschirm · metal, fabric shade ·
 metale, abat-jour tissu · metaal, Stoffen kap ·
 metal, Pantalla de tela · metallo, paralume in tessuto ·
 metal, abajur textil · metalli, kangas varjostin ·
 metal, Klosz z materiału

Stehleuchte · Floor lamp
 ↑ 170 cm, Ø 40 cm, √ 35 cm
 excl. 1 x E27, max. 60 W
 excl. 1 x E14, max. 18 W



403900201
 403900208
 403900211



01 | Nickel matt, Schirm Weiß ·
 nickel mat, shade white



08 | Messing matt, Schirm Creme-Weiß ·
 brass mat, shade cream white



11 | Nickel matt, Schirm Grau ·
 nickel mat, shade grey



MOTEL

Metall, Stoffschild · metal, fabric shade ·
 metale, abat-jour tissu · metaal, Stoffen kap · metal, Pantalla de tela · metallo, paralume in tessuto ·
 metal, abajur textil · metalli, kangas varjostin · metal, Klosz z materiału



07 | Nickel matt, Schirm Schwarz/Weiß ·
 nickel mat, shade black/white



08 | Messing matt, Schirm Schwarz/goldfarbig ·
 brass mat, shade black/gold

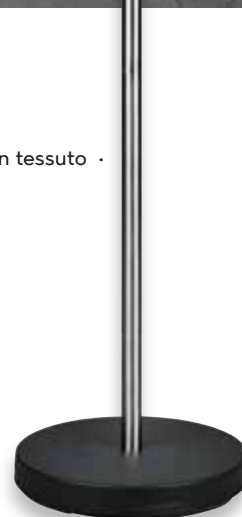

Stehleuchte · Floor lamp
 ↓ 164 cm, Ø 40 cm, ↗ 54 cm
 excl. 1 x E27, max. 60 W
 excl. 1 x E14, max. 10 W



416900207
 416900208



CLAAS

Metall, Stoff · metal, fabric ·
metale, tissu · metaal, textiel · metal, tela ·
metallo, tessuto · metal, textil · metalli, tekstiili ·
metal, tkanina



USB Anschluss mit Ladefunktion ·
Recharging USB connection

07 | Nickel matt · nickel mat

32 | Schwarz matt · black mat



Stehleuchte · Floor lamp
↑ 160 cm, ↔ 40 cm, ↗ 40 cm
excl. 1 x E27, max. 60 W



400400107
400400132



PARIS II

Nickel matt oder Messing matt · nickel mat or brass mat ·
 nickel mat ou laiton mat · nikkel mat of messing mat ·
 níquel mate o bronze mate · nichel opaco o ottone satinato ·
 nichel mat sau bronz mat · harjattu teräs tai mattamessinki ·
 nikiel mat lub mosiądz mat

07 | Nickel matt · nickel mat

08 | Messing matt · brass mat



Tischleuchte · Table lamp
 † 58 cm, Ø 35 cm
 excl. 1 x E27, max. 60 W



500200107
500200108



Stehleuchte · Floor lamp
 † 160 cm, Ø 50 cm
 excl. 1 x E27, max. 60 W



400200107
400200108

1x

2x

3x



Getrennt schaltbar · Separately switchable
 Interrupteurs séparés · Gescheiden schakelbaar ·
 Interruptores separados · Interruttori separati ·
 Intrerupatoare separate · Erikseen kytkettävissä ·
 Oddzieleny przełącznik

390



NANDOR

Metall, Stoff · metal, fabric ·
 metale, tissu · metaal, textiel · metal, tela ·
 metallo, tessuto · metal, textil · metalli, tekstiili · metal, tkanina



07 | Nickel matt · nickel mat



79 | goldfarbig · gold



Tischleuchte · Table lamp

↑ 62 cm, Ø 30 cm
 incl. 2 x SMD, 3 W
 2 x 300 lm, 3.000 K
 excl. 1 x E27, max. 40 W



575310307
 575310379



Stehleuchte · Floor lamp

↑ 160,5 cm, Ø 40 cm
 incl. 2 x SMD, 7 W
 2 x 700 lm, 3.000 K
 excl. 1 x E27, max. 60 W



475310307
 475310379

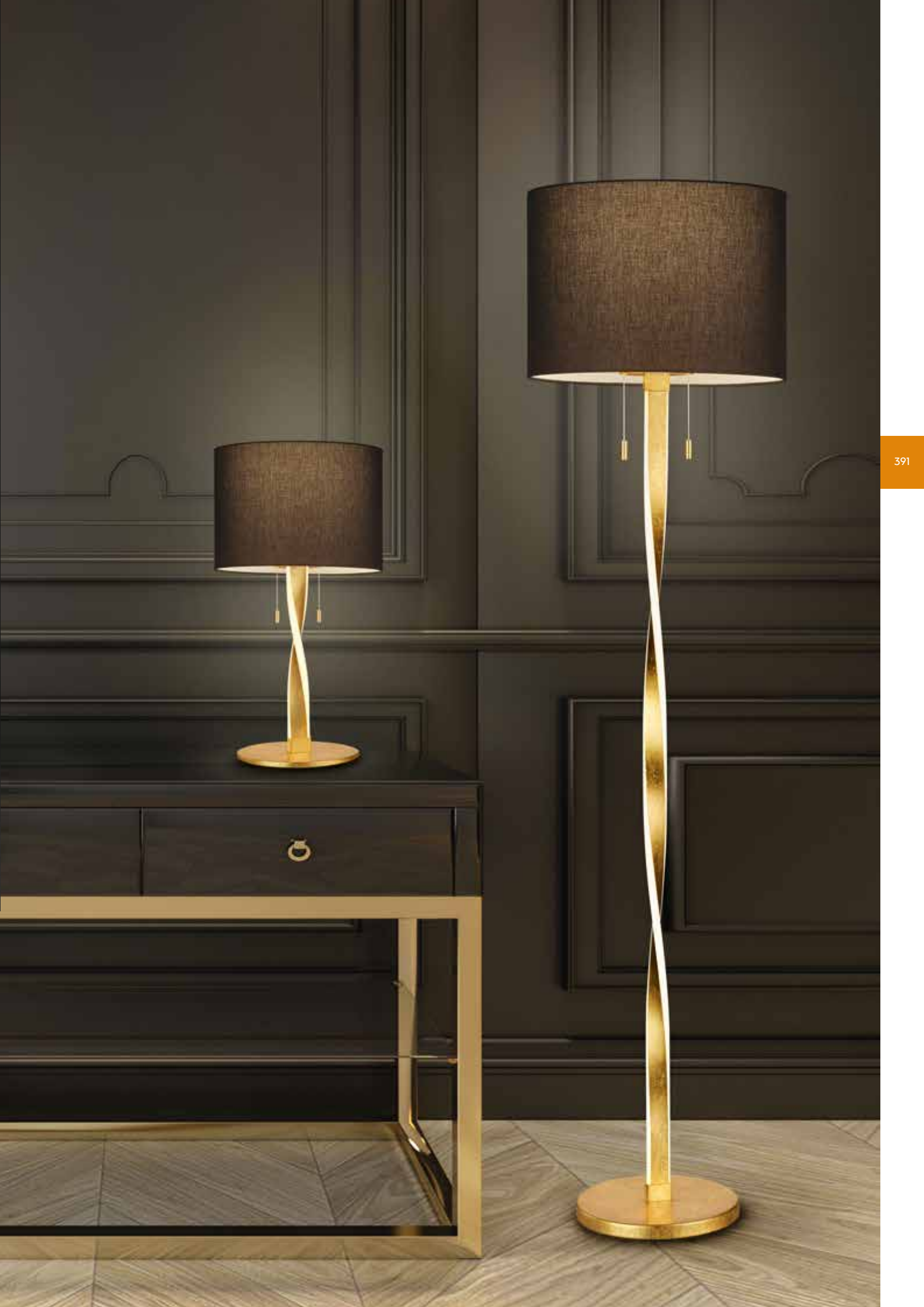

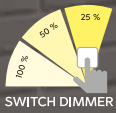

TEXEL

Metall Schwarz matt/goldfarbig · metal black mat/gold ·
 metallo nero opaco/oro · metal negro mat/aur · metalli musta matto/kultaa ·
 metal czarny mat/złota



Tischleuchte · Table lamp
 ↓ 47,5 cm, Ø 16 cm
 incl. 1 x SMD-LED, 6,8 W
 650 lm, 3.000 K



574410179



Stehleuchte · Floor lamp
 ↓ 142,5 cm, Ø 25 cm
 incl. 1 x SMD-LED, 15 W
 1.450 lm, 3.000 K



474410179



LIÈGE

Holz, Metall, Schwarz matt/goldfarbig · wood, metal, black mat/gold ·
 bois, metale, noir mat/or · hout, metaal, mat zwart/goud ·
 madera, metal, estera negra/oro · di legno, metallo, nero opaco/oro ·
 lemn, metal, negru mat/aur · puu, metalli, mattamusta/kultaa ·
 drewno, metal, czarny mat/złota

Empfohlen:

recommended: Filament LED E27, 7 W
 806 lm, 2.700 K



987-6810



Stehleuchte · Floor lamp

↑ 120 - 160 cm, ↔ 80 cm
 excl. 1 x E27, max. 60 W



407800132



LANCE

Metall, Chrom oder Schwarz, Glas rauchfarbig oder mehrfarbig ·
 metal, chrome or black, glass smoke or multicolor ·
 metals, chrome ou noir, verre fumé ou multicolore ·
 metaal, chrom of zwart, glas rookkleur of multicolor ·
 metal, cromo o negro, vidrio humo o multicolor ·
 metallo, cromo o nero, vetro fume' o multicolore ·
 metal, crom sau negru, sticla fumuriu sau multicolor ·
 metalli, kromi tai musta, lasi savu tai monivärinen ·
 metal, chrom lub czarny, szkło przydymiony lub multi-kolor

Stehleuchte · Floor lamp

↑ 156 cm, Ø 60 cm
 excl. 3 x E14, max. 28 W



403400317 | mehrfarbig · multicolor

403400354 | rauchfarbig · smoke



Chrom, Glas rauchfarbig ·
 chrome, glass smoke



Schwarz matt, Glas multicolor ·
 black mat, glass multicolor





SOLA

Chrom, Marmor, Acryl · chrome, marble, acryl ·
 chrome, marbre, acryl · chroom, marmer, acryl ·
 cromo, mármol, acrílico · cromo, marmo, acrilico ·
 crom, marmura, acrilic · kromi, marmori, akryyli ·
 chrom, marmur, akryl

Stehleuchte · Floor lamp
 ↑ 176 - 200 cm, ↗ 180 cm, Ø 40 cm
 excl. 1 x E27, max. 75 W



4200011-06



ARGENTINA

Nickel matt oder Messing matt, Marmor · nickel mat or brass mat, marble ·
 nickel mat ou laiton mat, marbre · nikkel mat of messing mat, marmar · níquel mate o bronze mate, mármol ·
 nichel opaco o ottone satinato, marmo · nichel mat sau bronz mat, marmura · afstandsbediening tai geïntegreerde dimmer, marmori ·
 nikiel mat lub mosiądz mat, marmur

Stehleuchte · Floor lamp
 ↑ 200 cm, Ø 38 cm, √ 172,5 cm
 excl. 1 x E27, max. 60 W



411700107
 411700108





BANGKOK

Metall, Schwarz matt, Marmor · metal, black mat, marble ·
 métal, noir mat, marbre · metaal, mat zwart, marmer · metal, estera negra, mármol ·
 metallo, nero opaco, marmo · metal, negru mat, marmura · metalli, mattamusta, marmori ·
 metal, czarny mat, marmur



Integrierter Dimmer ·
 Integrated dimmer

Stehleuchte · Floor lamp

↑ 180 cm, ↔ 22 x 23 cm, ↗ 127,5 cm
 incl. SMD-LED, 18 W
 2.200 lm, 3.000 K



426511832



SHANGHAI

Metall · metal ·
metale · metaal · metallo ·
metal · metalli · metal



Integrierter Dimmer ·
Integrated dimmer

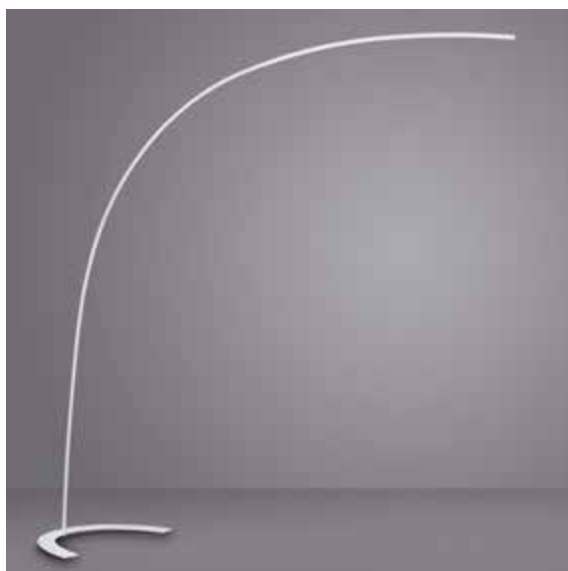

Stehleuchte · Floor lamp
↓ 210 cm, ↔ 65 cm, ↗ 200 cm
incl. SMD-LED, 18 W
2.000 lm, 3.000 K



427511801
427511802



3.000 K

4.500 K

6.500 K



Dimmen und Lichtfarbe einstellen ·
 Dimming and adjusting light color ·
 Varier et choisir la couleur de la lumière ·
 Dimmen en lichtkleur instellen ·
 Atenuación y ajuste del color de la luz ·
 Variare e scegliere il colore della luce ·
 Variati lumina si ajustati culoarea luminii ·
 Himmennys ja värilämpötilan säätö vakiokytkimellä ·
 ściemniać i jasność ustawić



QUEBEC

Nickel matt oder Messing matt · nickel mat or brass mat ·
 nickel mat ou laiton mat · nikkel mat of messing mat ·
 níquel mate o bronze mate · nichel opaco o ottone satinato ·
 nichel mat sau bronz mat · harjattu teräs tai mattamessinki ·
 nikiel mat lub mosiądz mat



Lichtfarbe einstellbar ·
 Adjustable light color



Integrierter Dimmer ·
 Integrated dimmer



Memory Funktion ·
 Memory function



07 | Nickel matt · nickel mat



08 | Messing matt · brass mat

Stehleuchte · Floor lamp

↓ 180 cm, ↗ 35 cm
 incl. SMD-LED, 35 W
 4.200 lm, 3.000 + 4.500 + 6.500 K
 incl. SMD-LED, 5,5 W
 600 lm, 3.000 + 4.500 + 6.500 K



422710307

422710308



BRANTFORD

Metall · metal ·
metale · metaal · metal · metallo · metal · metalli · metal

 Lichtfarbe einstellbar ·
Adjustable light color

 Sensordimmer ·
Sensor dimmer

 Memory Funktion ·
Memory function



04 | Altmessing · old brass



07 | Nickel matt · nickel mat



08 | Messing matt · brass mat



32 | Schwarz matt · black mat

Stehleuchte · Floor lamp
 ↓ 180 cm, ↔ 30 cm, ↗ 41,6 cm
 incl. SMD-LED, 30 W
 3.500 lm, 2.700 + 3.200 + 4.000 K
 incl. SMD-LED, 6,5 W
 650 lm, 2.700 + 3.200 + 4.000 K



425610204
 425610207
 425610208
 425610232





GRANBY

Metall · metal ·
metale · metaal · metal ·
metallo · metal · metalli · metal

 Lichtfarbe einstellbar ·
Adjustable light color

 Sensordimmer ·
Sensor dimmer

 Memory Funktion ·
Memory function

 **04** | Altmessing · old brass

 **07** | Nickel matt · nickel mat

 **08** | Messing matt · brass mat

 **32** | Schwarz matt · black mat

Stehleuchte · Floor lamp
↓ 180 cm, ↔ 29,5 cm, ↗ 46 cm
incl. SMD-LED, 29 W
3.400 lm, 2.700 + 3.200 + 4.000 K
incl. SMD-LED, 6,5 W
650 lm, 2.700 + 3.200 + 4.000 K



424310204
424310207
424310208
424310232



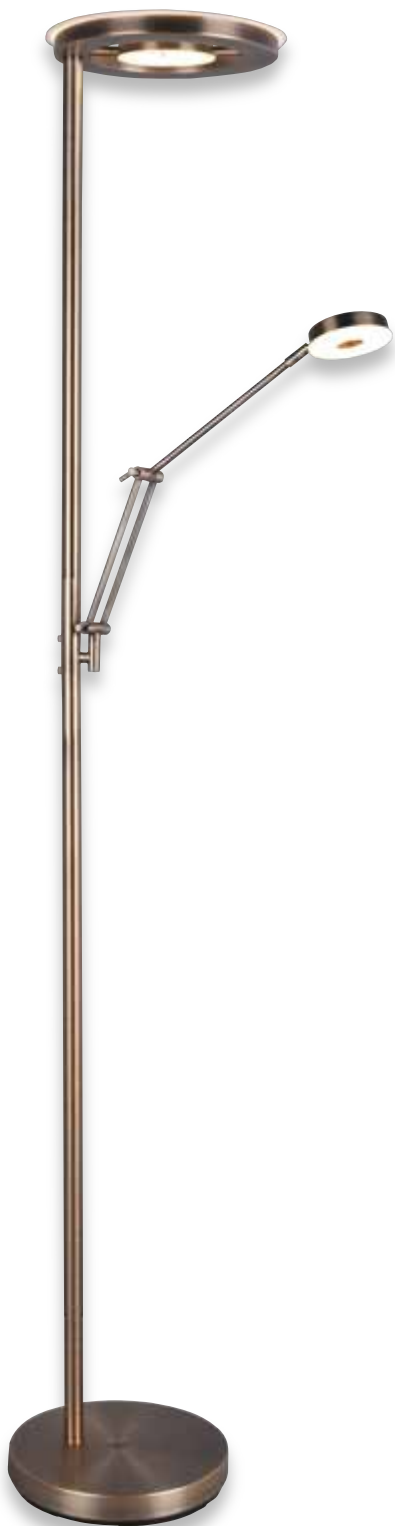

BARRIE

Metall · metal ·
metale · metaal · metal · metallo ·
metal · metalli · metal

 Lichtfarbe einstellbar ·
Adjustable light color

 Sensordimmer ·
Sensor dimmer

 Memory Funktion ·
Memory function

 **04** | Altmessing · old brass

 **07** | Nickel matt · nickel mat

 **32** | Schwarz matt · black mat

Stehleuchte · Floor lamp
↑ 181 cm, Ø 30 cm, ∠ 70 cm
incl. SMD-LED, 32 W, 3.700 lm
incl. SMD-LED, 6 W, 700 lm
2.700 + 4.000 K



424210304
424210307
424210332





CHRIS

Chrom, Acryl mit Kristalleffekt · chrome, broken glass optic ·
 chrome, optique verre pilé · chrom, gebroken glas optiek ·
 cromo, efecto cristal roto · cromo, effetto ottico vetro rotto ·
 crom, aspect de sticla sparta · kromi, lasi efekti optiikka ·
 chrom, optyczne rozbite szkło



Integrierter Dimmer ·
 Integrated dimmer

Deckenleuchte · Ceiling lamp

↓ 180 cm, ↗ 52 cm

incl. 1 x SMD-LED, 18 W, 2.000 lm, 3.000 K

incl. 1 x SMD-LED, 3,8 W, 350 lm, 3.000 K



478310206





SPLIT

Nickel matt · nickel mat ·
nickel mat · nikkell mat · níquel mate ·
nichel opaco · nichel mat · harjattu teräs · nikiel mat



Lichtfarbe stufenlos einstellbar ·
Light color infinitely variable



Integrierter Dimmer ·
Integrated dimmer



Memory Funktion ·
Memory function

Stehleuchte · Floor lamp
↑ 181 cm, ↔ 33 cm, ↗ 43 cm
incl. SMD-LED, 20 W
2.000 lm, 3.000 - 6.500 K
incl. 1 x SMD-LED, 3,5 W
340 lm, 3.000 - 6.500 K



424910207



410

ARIZONA

Nickel matt oder Messing matt · nickel mat or brass mat ·
nickel mat ou laiton mat · nikkell mat of messing mat ·
níquel mate o bronce mate · nichel opaco o ottone satinato ·
nichel mat sau bronz mat · harjattu teräs tai mattamessinki ·
nikiel mat lub mosiądz mat



Sensordimmer ·
Sensor dimmer



07 | Nickel matt · nickel mat



08 | Messing matt · brass mat

Stehleuchte · Floor lamp

↑ 180 cm, Ø 25,5 cm, √ 40 cm

incl. SMD-LED, 20 W, 2.200 lm, 3.000 K

incl. 1 x SMD-LED, 5 W, 500 lm, 3.000 K



426410207

426410208





SANTO II

Metall, Glas alabasterfarbig · metal, alabaster-coloured glass ·
metale, verre couleur albâtre · metaal, albastkleurig glas ·
metal, vidrio de color alabastro · metallo, vetro colore alabastro ·
metal, sticla culoare alabastru · metalli, lasi alabasteri väri ·
metal, szkło alabaster kolor



Integrierter Dimmer ·
Integrated dimmer



07 | Nickel matt · nickel mat



28 | rostfarbig antik · antique rust

Stehleuchte · Floor lamp

↑ 180 cm, Ø 25,5 cm, √ 40 cm

incl. 4 x SMD-LED, 4,8 W, 4 x 450 lm, 3.000 K

incl. 1 x SMD-LED, 4,8 W, 450 lm, 3.000 K



421910207

421910228



BERGAMO

Nickel matt oder Messing matt · nickel mat or brass mat ·
 nickel mat ou laiton mat · nikkell mat of messing mat ·
 níquel mate o bronce mate · nichel opaco o ottone satinato ·
 nichel mat sau bronz mat · harjattu teräs tai mattamessinki ·
 nikiel mat lub mosiądz mat



Sensordimmer ·
 Sensor dimmer



07 | Nickel matt · nickel mat

08 | Messing matt · brass mat



Tischleuchte · Table lamp
 ↓ 50 cm, ↗ 40 cm
 incl. 1 x SMD-LED, 12 W
 1.100 lm, 3.000 K



520910107
520910108



Stehleuchte · Floor lamp
 ↓ 135 cm, ↗ 50 cm
 incl. 1 x SMD-LED, 12 W
 1.100 lm, 3.000 K



420910107
420910108



VERONA

Nickel matt · nickel mat ·
nickel mat · nikkell mat · níquel mate · nichel opaco ·
nichel mat · harjattu teräs · nikiel mat



Sensordimmer · Sensor dimmer
Variateur tactile · Touchdimmer ·
Regulador con sensor · Touchdimmer ·
Variator cu senzor · Kosketushimmennin ·
Czujnik ściemniania ·



Stehleuchte · Floor lamp
↓ 126 cm, ↗ 60 cm
incl. 1 x SMD-LED, 12 W
1.100 lm, 3.000 K



420810107



MONZA

Metall · metal ·
metale · metaal · metal ·
metallo · metal · metalli · metal



Tischleuchte · Table lamp
↓ 57 cm, ↔ 19 cm, ↗ 46 cm
incl. SMD-LED, 12 W
1.400 lm, 2.300 + 3.000 + 4.000 K



523310107
523310108
523310131
523310132





Stehleuchte · Floor lamp
↓ 145 cm, ↔ 25 cm, ↗ 50 cm
incl. SMD-LED, 12 W
1.400 lm, 2.300 + 3.000 + 4.000 K



423310107
423310108
423310131
423310132



 Lichtfarbe einstellbar ·
Adjustable light color

 Sensordimmer ·
Sensor dimmer

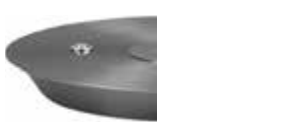

07 | Nickel matt · nickel mat



08 | Messing matt · brass mat



31 | Weiß · white



32 | Schwarz matt · black mat





PAVIA

Metall, Altmessing, Schwarz matt oder Weiß matt · metal, old brass, black mat or white mat · métal, laiton fumé, noir mat ou blanc mat · metaal, oud brons, mat zwart of wit mat · metal, bronce viejo, estera negra o estera blanca · metallo, ottone invecchiato, nero opaco o bianco opaco · metal, bronz antic, negru mat sau alb mat · metalli, antiikkimessinki, mattamusta tai mattavalkoinen · metal, patyna, czarny mat lub biały mat

 Lichtfarbe einstellbar ·
Adjustable light color

 Integrierter Dimmer ·
Integrated dimmer



04 | Altmessing · old brass



31 | Weiß matt · white mat



32 | Schwarz matt · black mat



Tischleuchte · Table lamp
↑ 38,5 cm, ↔ 14 cm, ↗ 43 cm
incl. SMD-LED, 12 W
1.400 lm, 2.300 + 3.000 + 4.000 K



570310104
570310131
570310132



Stehleuchte · Floor lamp
↑ 130,5 cm, ↔ 16 cm, ↗ 48 cm
incl. SMD-LED, 12 W
1.400 lm, 2.300 + 3.000 + 4.000 K



470310104
470310131
470310132



Sensordimmer ·
Sensor dimmer



Seite/page 580

KAZAN

Metall, schwarz matt · metal, black mat ·
 metale, noir mat · metaal, mat zwart · metal, estera negra ·
 metallo, nero opaco · metal, negru mat · metalli, mattamusta ·
 metal, czarny mat



Wandleuchte · Wall lamp

Ø 14 cm, ↗ max. 55 cm
 incl. 1 x SMD, 8 W
 800 lm, 3.000 K



274770132



Stehleuchte · Floor lamp

↓ 121,5 cm, ↔ 24 cm, ↗ max. 61,5 cm
 incl. 1 x SMD, 8 W
 800 lm, 3.000 K



474790132





NARCOS

Nickel matt oder Schwarz matt · nickel mat or black mat ·
 nickel mat ou noir mat · nikkel mat of mat zwart · níquel mate o estera negra ·
 nichel opaco o nero opaco · nichel mat sau negru mat · harjattu teräs tai musta matto · nikiel mat lub czarny mat



4 fach TOUCH ·
 4 level Touch function

Stehleuchte · Floor lamp

↑ 154 cm, ↔ 28 cm
 incl. 3 x SMD-LED, 4,7 W
 3 x 470 lm, 3.000 K



473190307
 473190332



07 | Nickel matt · nickel mat



32 | Schwarz matt · black mat



FILIGRAN

Nickel matt oder Schwarz matt · nickel mat or black mat ·
 nickel mat ou noir mat · nikkel mat of mat zwart · níquel mate o estera negra ·
 nichel opaco o nero opaco · nichel mat sau negru mat · harjattu teräs tai mattamusta · nikiel mat lub czarny mat



Sensordimmer ·
 Sensor dimmer

Stehleuchte · Floor lamp

↓ 162 cm, ↗ 52 cm
 incl. 1 x SMD-LED, 6,5 W
 700 lm, 3.000 K



420490107
 420490132



07 | Nickel matt · nickel mat

32 | Schwarz matt · black mat





DAKOTA

Metall, schwarz matt · metal, black mat ·
 metale, noir mat · metaal, mat zwart · metal, estera negra ·
 metallo, nero opaco · metal, negru mat · metalli, mattamusta · metal, czarny mat

Empfohlen:

recommended: LED G9, 3 W
 300 lm, 3.000 K



929-230



Stehleuchte · Floor lamp

↑ 155 cm, ↔ 23 cm
 excl. 3 x G9, max. 28 W



404600332



EDWARD

Metall, Schwarz matt · metal, black mat ·
 metale, noir mat · metaal, mat zwart ·
 metal, estera negra · metallo, nero opaco ·
 metal, negru mat · metalli, mattamusta ·
 metal, czarny mat

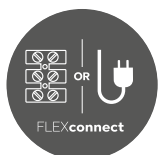

Seite/page 580



Wandleuchte · Wall lamp
 ↑ 25 cm, ↔ 12 cm, ↗ 50 cm
 excl. 1 x E14, max. 40 W



208870132



Stehleuchte · Floor lamp
 ↑ 160 cm, ↔ 38 cm
 excl. 3 x E14, max. 40 W



408800332



Tischleuchte · Table lamp
↓ 45 cm, ↔ 12 cm, ↗ 25 cm
excl. 1 x GU10, max. 5 W



- 512400107
- 512400108
- 512400131
- 512400132



Stehleuchte · Floor lamp
↓ 151 cm, ↔ 23 cm, ↗ 39 cm
excl. 1 x GU10, max. 5 W



- 412400107
- 412400108
- 412400131
- 412400132





MARLEY

Metall · metal ·
metale · metaal · metal · metallo · metal · metalli · metal

Empfohlen:
recommended: LED GU10, 4,5 W
345 lm, 3.000 K



956-55



07 | Nickel matt · nickel mat



08 | Messing matt / Schwarz matt
brass matt / black mat



31 | Weiß matt · white mat



32 | Schwarz matt · black mat



FREDDY

Nickel matt, Glas matt · nickel mat, mat glass ·
 nickel mat, verre mat · nikkell mat, mat glas · níquel mate, vidrio mate ·
 nichel opaco, vetro sabbiato · nichel mat, sticla mata ·
 harjattu teräs, mattalasi · nikiel mat, szkło matowane



incl.
 LED E14, 3,5 W
 320 lm, 3.000 K

983-40



Stehleuchte · Floor lamp
 ↓ 125 cm, ↗ 55 cm
 incl. 2 x LED E14, 4 W
 2 x 320 lm, 3.000 K



424810207



Stehleuchte · Floor lamp
 ↓ 150 cm, ↗ 55 cm
 incl. 1 x LED E14, 4 W
 320 lm, 3.000 K



424810107



ICARO

Metall, Glas matt · metal, mat glass ·
 metale, verre mat · metaal, mat glas · metal, vidrio mate ·
 metallo, vetro sabbiato · metal, sticla mata · metalli, mattalasi · metal, szkło matowane

Stehleuchte · Floor lamp
 ↓ 165 cm, ↗ 54 cm
 excl. 1 x E27, max. 60 W



4035011-04
 4035011-07
 4035011-08

 **04** | Altmessing · old brass

 **07** | Nickel matt · nickel mat

 **08** | Messing matt · brass mat





BALE

Stoff · fabric ·
tissu · textiel · tela ·
tessuto · textil · tekstiili · tkanina

Tischleuchte · Table lamp

↑ 40 cm, Ø 24 cm
excl. 2 x E27, max. 40 W



505200112
505200149
505200177
505200183



12 | Blau ·
blue



49 | Pistaziengrün ·
pistachio green



77 | Ultimate Grau ·
ultimate grey



83 | Illuminate Gelb ·
illuminate yellow



NOLA

Metall, Weiß matt oder Schwarz matt · metal, white mat or black mat ·
 metale, blanc mat ou noir mat · metaal, wit mat of mat zwart ·
 metal, estera blanca o estera negra · metallo, bianco opaco o nero opaco ·
 metal, alb mat sau negru mat · metalli, valkoinen matto tai musta matto ·
 metal, biały mat lub czarny mat



31 | Weiß matt · white mat



32 | Schwarz matt · black mat



Tischleuchte · Table lamp
 ↑ 30,5 cm, Ø 20 cm
 excl. 1 x E14, max. 40 W



506200131
 506200132



Tischleuchte · Table lamp
 ↑ 45 cm, Ø 30 cm
 excl. 1 x E27, max. 40 W



506290131
 506290132



4 fach TOUCH ·
4 level Touch function

CURTIS

Altmessing, Nickel matt oder Messing matt · old brass, nickel mat or brass mat ·
laiton fumé, nickel mat ou laiton mat · oud brons, nikkell mat of messing mat ·
bronce viejo, níquel mate o bronce mate · ottone invecchiato, nichel opaco o
ottone satinato · bronz antic, nichel mat sau bronz mat · antiikkimesinki,
harjattu teräs tai mattamessinki · patyna, nikiel mat lubmosiądz mat



04 | Altmessing · old brass



07 | Nickel matt · nickel mat



08 | Messing matt · brass mat



32 | Schwarz matt · black mat



Tischleuchte · Table lamp
↓ 35 cm, ↔ 18 cm, ↗ max. 15 cm
incl. SMD-LED, 4 W
400 lm, 3.000 K



579790104
579790107
579790108
579790132



Wandleuchte · Wall lamp
↓ 35 cm, ↔ 18 cm, ↗ max. 35 cm
incl. SMD-LED, 4 W
430 lm, 3.000 K



279770104
279770107
279770108
279770132



Integrierter Dimmer ·
Integrated dimmer



DONNA

Metall, Glas alabasterfarbig · metal, alabaster-coloured glass ·
metale, verre couleur albâtre · metaal, albastkleurig glas ·
metal, vidrio de color alabastro · metallo, vetro colore
alabastro · metal, sticla culoare alabastru · metalli, lasi
alabasteri väri · metal, szkło alabaster kolor



4 fach TOUCH ·
4 level Touch function



07 | Nickel matt · nickel mat



08 | Messing matt · brass mat



432

Tischleuchte · Table lamp

↑ 30 cm, Ø 22,5 cm
incl. 1 x SMD-LED, 4,5 W
450 lm, 3.000 K



525790107
525790108

JOOST II

Nickel matt, Glas matt · nickel mat, mat glass ·
nickel mat, verre mat · nikkell mat, mat glas ·
níquel mate, vidrio mate · nichel opaco, vetro sabbiato ·
nichel mat, sticla mata · harjattu teräs, mattalasi ·
nikiel mat, szkło matowane



On/Off Touch Funktion ·
On/Off Touch function

Empfohlen:

recommended: LED E27, 8,5 W
806 lm, 3.000 K



988-10



Tischleuchte · Table lamp

↑ 39 cm, Ø 19 cm
excl. 1 x E27, max. 40 W



592300107



VENTURA

Metall, Glas matt · metal, mat glass ·
 metale, verre mat · metaal, mat glas · metal, vidrio mate ·
 metallo, vetro sabbato · metal, sticla mata · metalli, mattalasi ·
 metal, szkło matowane



4 fach TOUCH ·
 4 level Touch function



03 | Messing poliert · polished brass



07 | Nickel matt · nickel mat



Tischleuchte · Table lamp
 ↑ 29 cm, Ø 15,5 cm
 incl. 1 x SMD-LED, 4 W
 350 lm, 3.000 K



529990103
 529990107

CRISTO

Chrom oder Nickel matt, Glas · chrome or nickel mat, glass · chrome ou nickel mat, verre · chrom of nikkell mat, glas · cromo o níquel mate, vidrio · cromo o nichel opaco, vetro · crom sau nichel mat, sticla · kromi tai harjattu teräs, lasi · chrom lub nikiel mat, szkło



4 fach TOUCH ·
4 level Touch function



00 | Chrome, Transparent ·
chrome, transparent



07 | Nickel matt, Glas weiß ·
nickel mat, glass white



434

Tischleuchte · Table lamp

↑ 14,5 cm, Ø 11 cm
incl. 1 x SMD-LED, 4,3 W
430 lm, 3.000 K



529690100
529690107

EMERALD

Metall, Glas matt · metal, mat glass ·
metale, verre mat · metaal, mat glas · metal, vidrio mate ·
metallo, vetro sabbaiato · metal, sticla mata ·
metalli, mattalasi · metal, szkło matowane



4 fach TOUCH ·
4 level Touch function



06 | Chrom · chrome



07 | Nickel matt · nickel mat

Tischleuchte · Table lamp

↑ 29 cm, Ø 15 cm
incl. 1 x SMD-LED, 4,5 W
450 lm, 3.000 K



525490106
525490107





BERLIN

Metall, Glas matt · metal, mat glass ·
 metale, verre mat · metaal, mat glas ·
 metal, vidrio mate · metallo, vetro sabbato ·
 metal, sticla mata · metalli, matalasi ·
 metal, szkło matowane · metal, mat cam



4 fach TOUCH ·
 4 level Touch function



07



79

Tischleuchte · Table lamp
 ↑ 39 cm, Ø 19,5 cm
 incl. 1 x SMD-LED, 4,5 W
 450 lm, 3.000 K



527590107 | Nickel matt · nickel mat
 527590179 | goldfarbig · gold

ARY II

Metall, Glas matt · metal, mat glass ·
metale, verre mat · metaal, mat glas · metal, vidrio mate ·
metallo, vetro sabbiato · metal, sticla mata ·
metalli, matalasi · metal, szkło matowane



On/Off Touch Funktion ·
On/Off Touch function



07 | Nickel matt · nickel mat



32 | Schwarz matt · black mat

436

Tischleuchte · Table lamp

↓ 15 cm, Ø 9 cm
excl. 1 x E14, max. 40 W



591000107

591000132



TILL II

Metall, Glas matt · metal, mat glass ·
metale, verre mat · metaal, mat glas · metal, vidrio mate ·
metallo, vetro sabbiato · metal, sticla mata ·
metalli, matalasi · metal, szkło matowane



On/Off Touch Funktion ·
On/Off Touch function

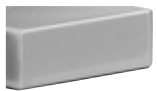

07 | Nickel matt · nickel mat



32 | Schwarz matt · black mat

Tischleuchte · Table lamp

↓ 14,5 cm, ↔ 10 x 15 cm
excl. 1 x E14, max. 40 W



590200107

590200132





DAVI II

Metall, Glas matt · metal, mat glass ·
 metale, verre mat · metaal, mat glas · metal, vidrio mate ·
 metallo, vetro sabbato · metal, sticla mata · metalli, mattalasi ·
 metal, szkło matowane



On/Off Touch Funktion ·
 On/Off Touch function

Empfohlen:
 recommended: LED E14, 4,9 W
 470 lm, 3.000 K



983-66



07 | Nickel matt ·
 nickel mat



32 | Schwarz matt ·
 black mat



Tischleuchte · Table lamp
 ↓ 15 cm, ↔ 12 x 15 cm
 excl. 1 x E14, max. 40 W



590100107
 590100132

LUIS II

Metall, Glas alabasterfarbig · metal, alabaster-coloured glass ·
metale, verre couleur albâtre · metaal, albastkleurig glas ·
metal, vidrio de color alabastro · metallo, vetro colore
alabastro · metal, sticla culoare alabastru · metalli, lasi
alabasteri väri · metal, szkło alabaster kolor



On/Off Touch Funktion ·
On/Off Touch function

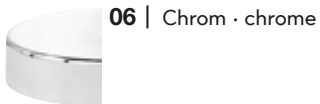

06 | Chrom · chrome

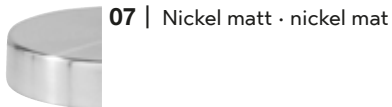

07 | Nickel matt · nickel mat

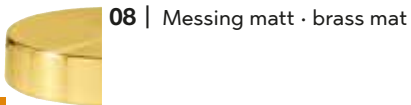

08 | Messing matt · brass mat

438

Tischleuchte · Table lamp

↓ 32 cm, Ø 12
excl. 1 x E14, max. 40 W



Empfohlen:
recommended: LED E14, 4,9 W
470 lm, 3.000 K



983-66

595700106
595700107
595700108



MATS II

Nickel matt, Stoff · nickel mat, fabric ·
nickel mat, tissu · nikkell mat, textiel · níquel mate, tela ·
nichel opaco, tessuto · nichel mat, textil ·
harjattu teräs, tekstiili · nikiel mat, tkanina



On/Off Touch Funktion ·
On/Off Touch function



01 | Weiß · white



42 | Anthrazit · anthacite



15 | Grün · green



19 | Türkis · turquoise

Tischleuchte · Table lamp

↓ 24 cm, Ø 14 cm
excl. 1 x E14, max. 40 W



Empfohlen:
recommended: LED E14, 4,9 W
470 lm, 3.000 K



983-66

599700101
599700115
599700119
599700142





FYNN II

Metall, Glas alabasterfarbig · metal, alabaster-coloured glass ·
 metale, verre couleur albâtre · metaal, albastkleurig glas ·
 metal, vidrio de color alabastro · metallo, vetro colore alabastro ·
 metal, sticla culoare alabastru · metalli, lasi alabasteri väri ·
 metal, szkło alabaster kolor

 On/Off Touch Funktion ·
 On/Off Touch function

Empfohlen:
 recommended: LED E14, 4,9 W
 470 lm, 3.000 K



983-66



Tischleuchte · Table lamp
 † 21 cm, Ø 15 cm
 excl. 1 x E14, max. 40 W



599100106 | Chrom · chrome
 599100107 | Nickel matt · nickel mat
 599100108 | Messing matt · brass mat
 599100118 | Orange · orange
 599100124 | rostfarbig · rusty



AMSTERDAM

Metall, Weiß oder Schwarz · metal, white or black ·
 metale, blanc ou noir · metaal, wit of zwart · metal, blanco o negro ·
 metallo, bianco o nero · metal, alb sau negru · metalli, valkoinen tai musta ·
 metal, biały lub czarny



+



Tischleuchte · Table lamp

↑ max. 90 cm, ↗ max. 90 cm, Ø 18 cm
 incl. 1 x COB-LED, 5 W
 500 lm, 3.000 K



527920101 | Weiß · white

527920102 | Schwarz · black



AVA

Kunststoff · plastic ·
 plastique · kunststof · plástico ·
 plastica · plastic · muovi · plastik



Lichtfarbe einstellbar ·
 Adjustable light color



Sensordimmer ·
 Sensor dimmer



USB Anschluss mit Ladefunktion ·
 Recharging USB connection



Memory Funktion ·
 Memory function



Tischleuchte · Table lamp
 ↑ 40,4 cm, ↔ 17,1 cm, ↗ 30,5 cm
 incl. SMD-LED, 5,2 W
 600 lm, 3.000 + 4.000 + 6.500 K



523090131 | Weiß matt · white mat
 523090132 | Schwarz matt · black mat



VARIO

Metall, Kunststoff, titanfarbig · metal, plastic, titan ·
 métal, plastique, titane · metaal, kunststof, titaan · metal, plástico, titán ·
 metallo, plastica, titano · metal, plastic, titaniu · metalli, muovi, titaani ·
 metal, plastik, tytanowy



Flexibel ·
Flexible



+



Tischleuchte · Table lamp
 ↓ max. 64,5 cm, ↗ max. 50 cm
 incl. SMD-LED, 3,6 W
 480 lm, 3.000 K



522520187



RADO

Metall, Kunststoff · metal, plastic ·
 metale, plastique · metaal, kunststof · metal, plástico ·
 metallo, plastica · metal, plastic · metalli, muovi · metal, plastik



Lichtfarbe einstellbar ·
 Adjustable light color



4 fach TOUCH ·
 4 level Touch function



31 | Weiß matt · white mat



32 | Schwarz matt · black mat



+



Tischleuchte · Table lamp
 ↓ 70 cm, ↗ 38 cm
 incl. 1 x SMD-LED, 5 W
 700 lm, 3.000 + 4.000 + 5.000 K



527690131
 527690132



KIMI

Metall, Holz · metal, wood ·
metale, bois · metaal, hout · metal, madera ·
metallo, di legno · metal, lemn · metalli, puu · metal, drewno

Empfohlen:
recommended: LED E27, 4 W
320 lm, 3.000 K



986-40



Tischleuchte · Table lamp
‡ max. 50 cm, Ø 16 cm, ↗ max. 37,5 cm
excl. 1 x E27, max. 42 W



508300131 | Weiß matt · white mat
508300132 | Schwarz matt · black mat



PERRY

Metall · metal ·
metale · metaal · metal · metallo · metal · metalli · metal

Empfohlen:

recommended: LED E27, 4,9 W
470 lm, 3.000 K



987-60



Tischleuchte · Table lamp

↓ 46 cm, ↔ 16 cm, ↗ 28 cm
excl. 1 x E27, max. 10 W



504900104 | Altmessing · old brass
504900107 | Nickel matt · nickel mat
504900131 | Weiß matt · white mat
504900132 | Schwarz matt · black mat

POLO

Kunststoff · plastic ·
plastique · kunststof · plástico ·
plastica · plastic · muovi · plastik



Lichtfarbe einstellbar ·
Adjustable light color



4 fach TOUCH ·
4 level Touch function



446

Tischleuchte · Table lamp

↑ 41 cm, ↗ 40 cm
incl. 1 x SMD-LED, 5 W
550 lm, 3.000 + 4.000 + 5.000 K



527090111 | Grau · grey

527090131 | Weiß matt · white mat

FLEXO

Metall, Kunststoff · metal, plastic ·
metale, plastique · metaal, kunststof · metal, plástico ·
metallo, plastica · metal, plastic · metalli, muovi ·
metal, plastik



01 | Weiß · white

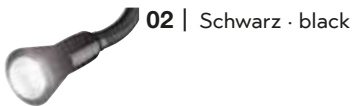

02 | Schwarz · black

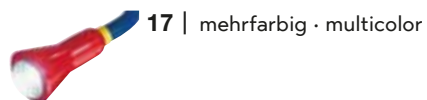

17 | mehrfarbig · multicolor

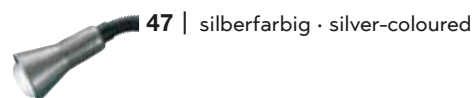

47 | silberfarbig · silver-coloured



Tischleuchte · Table lamp

↑ 30 cm, ↗ 30 cm
excl. 1x E14, max. 18 W



5028010-01

5028010-02

5028010-17

5028010-47



LUPO

Kunststoff · plastic · plastique · kunststof · plástico · plastica · plastic · muovi · plastik

 4 fach TOUCH · 4 level Touch function

 01 | Weiß · white

 02 | Schwarz · black



Tischleuchte · Table lamp
 † 35 cm, Ø 13,5 cm, ∟ 30 cm
 incl. 1 x SMD-LED, 5 W
 550 lm, 3.500 K



527290101
 527290102



PRONTO

Metall, Kunststoff · metal, plastic ·
 metale, plastique · metaal, kunststof · metal, plástico ·
 metallo, plastica · metal, plastic · metalli, muovi ·
 metal, plastik

Tischleuchte · Table lamp
 † 30 cm, Ø 13,1 cm, √ 22 cm
 excl. 1 x E27, max. 18 W



5027011-01
 5027011-17
 5027011-47



01 | Weiß · white



17 | mehrfarbig · multicolor



47 | silberfarbig · silver-coloured



TAJO

Metall · metal ·
metale · metaal · metal ·
metallo · metal · metalli · metal



01 | Weiß · white



47 | silberfarbig · silver-coloured



Tischleuchte · Table lamp
↓ 73,5 cm, Ø 16,8 cm, ↗ 51 cm
excl. 1 x E27, max. 40 W



5029010-01
5029010-47



Spotserien

Spots
Spotterie
Spots
Focos
Faretti
Spoturi
Spotit
Reflektorki



geeignet für Auf- und Einbau · suitable for both mounting and installation ·
 adapté au montage et à l'installation · geschikt voor in en opbouw ·
 apropiadas tanto para montaje como para instalación · ideale sia per montaggio e installazione ·
 adecvate pentru aplicare și încorporare · sopii pinta-ja uppoasennukseen ·
 odpowiednie zarówno do montażu jak i instalacji

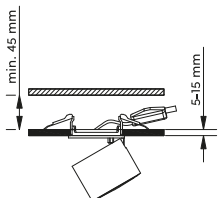

Strahler · Spot
 Ø 8,7 cm, ↑ 10,6 cm
 incl. SMD-LED, 5 W
 450 lm, 3.000 K
 incl. SMD-LED, 1,5 W
 110 lm, 3.000 K



652910131
 652910132

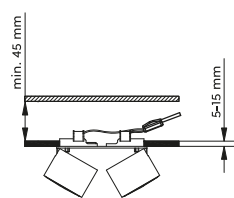

Strahler · Spot
 ↔ 18 x 8,7 cm, ↑ 10,6 cm
 incl. 2 x SMD-LED, 5 W
 2 x 450 lm, 3.000 K
 incl. 2 x SMD-LED, 1,5 W
 2 x 110 lm, 3.000 K



652910231
 652910232

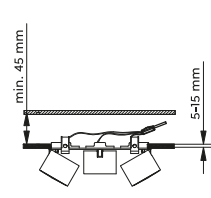

Strahler · Spot
 ↔ 27,3 x 8,7 cm, ↑ 10,6 cm
 incl. 3 x SMD-LED, 5 W
 3 x 450 lm, 3.000 K
 incl. 3 x SMD-LED, 1,5 W
 3 x 110 lm, 3.000 K



652910331
 652910332



31 | Weiß matt · white mat

32 | Schwarz matt · black mat



TAURUS

Metall, Weiß matt oder Schwarz matt · metal, white mat or black mat ·
 metale, blanc mat ou noir mat · metaal, wit mat of mat zwart · metal, estera blanca o estera negra ·
 metallo, bianco opaco o nero opaco · metal, alb mat sau negru mat · metalli, valkoinen matto tai musta matto · metal, biały mat lub czarny mat



Getrennt schaltbar ·
 Separately switchable



1x



2x



3x





geeignet für Auf- und Einbau · suitable for both mounting and installation ·
 adapté au montage et à l'installation · geschikt voor in en opbouw ·
 apropiadas tanto para montaje como para instalación · ideale sia per montaggio e installazione ·
 adecvate pentru aplicare și încorporare · sopii pinta- ja uppoasennukseen ·
 odpowiednie zarówno do montażu jak i instalacji



Empfohlen:
 recommended: LED GU10, 5 W
 400 lm, 3.000 K



956-5936

GUAYANA

Metall · metal ·
metale · metaal · metal ·
metallo · metal · metalli · metal

07 | Nickel matt · nickel mat



31 | Weiß matt · white mat



32 | Schwarz matt · black mat

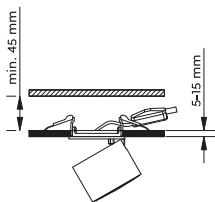

Strahler · Spot
Ø 8,7 cm, ↓ 12 cm
excl. 1 x GU10, max. 35 W



651000107
651000131
651000132

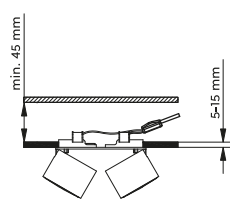

Strahler · Spot
↔ 18 x 8,7 cm, ↓ 12 cm
excl. 2 x GU10, max. 35 W



651000207
651000231
651000232

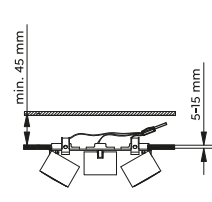

Strahler · Spot
↔ 27,3 x 8,7 cm, ↓ 12 cm
excl. 3 x GU10, max. 35 W



651000307
651000331
651000332



Strahler · Spot

↔ 36 x 7 cm, ↓ 18,5 cm
incl. 2 x SMD-LED, 4,3 W
2 x 430 lm, 3.000 K



821470205



Strahler · Spot

↔ 50 x 7 cm, ↓ 18,5 cm
incl. 3 x SMD-LED, 4,3 W
3 x 430 lm, 3.000 K



821410305



Strahler · Spot

↔ 96,5 x 8 cm, ↓ 18,5 cm
incl. 4 x SMD-LED, 4,3 W
4 x 430 lm, 3.000 K



821410405



Strahler · Spot

↔ max.150 x 8 cm, ↓ 24 cm
incl. 6 x SMD-LED, 4,3 W
6 x 430 lm, 3.000 K



821410605



CLAPTON

Aluminium gebürstet, Chrom, Glas Weiß gewischt · brushed aluminium, chrome, glass white brushed glass ·
 aluminium balayé, chrome, verre blanc balayé · geborsteld aluminium, chroom, wit geborsteld glas · aluminio pulido, cromo, blanco pulido ·
 alluminio spazzolato, cromo, vetro bianco spazzolato · aluminiu lucios, crom, alb lucios · harjattu alumiini, kromi, lasi harjattu valkoinen ·
 aluminium szczotkowane, chrom, szkło białe otarła



Strahler · Spot
 ↓ 20 x 7 cm, ↗ 16 cm
 incl. 1 x SMD-LED, 4,3 W
 430 lm, 3.000 K



821470105



Strahler · Spot
 ↔ 31 x 22 cm, ↓ 18,5 cm
 incl. 4 x SMD-LED, 4,3 W
 4 x 430 lm, 3.000 K



821430405



Strahler · Spot
 ↔ 70 x 50 cm, ↓ 23 cm
 incl. 5 x SMD-LED, 4,3 W
 5 x 430 lm, 3.000 K



621410505





Strahler · Spot
 ↓ 12 x 7,5 cm, ↗ 16 cm
 incl. SMD-LED, 6,5 W
 650 lm, 3.000 K



873170107
 873170131

Strahler · Spotp
 ↔ 28,5 x 9,5 cm, ↗ 16 cm
 incl. 2 x SMD-LED, 6,5 W
 2 x 650 lm, 3.000 K



873170207
 873170231

Strahler · Spot
 ↔ 45 x 7,5 cm, ↓ 16 cm
 incl. 3 x SMD-LED, 6,5 W
 3 x 650 lm, 3.000 K



873110307
 873110331

Strahler · Spot
 ↔ 81,5 x 8 cm, ↓ 20 cm
 incl. 4 x SMD-LED, 6,5 W
 4 x 650 lm, 3.000 K



873110407
 873110431



NARCOS

Nickel matt oder weiß · nickel mat or white ·
 nickel mat ou blanc · nikkel mat of wit · níquel mate o blanco · nichel opaco o bianco ·
 nichel mat sau alb · harjattu teräs tai valkoinen · nikiel mat lub biały



07 | Nickel matt · nickel mat



31 | Weiß matt · white mat

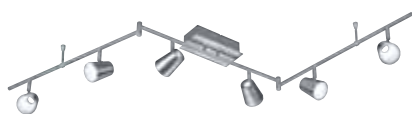

Strahler · Spot
 ↔ 177 x 10 cm, ↓ 23 cm
 incl. 6 x SMD-LED, 6,5 W
 6 x 650 lm, 3.000 K



873110607
 873110631



Tischleuchte · Table lamp
 ↑ 38 cm, ↗ 23 cm
 incl. SMD-LED, 6,9 W
 650 lm, 3.000 K



573190107
 573190131



Stehleuchte · Floor lamp
 ↓ 154 cm, ↔ 28 cm
 incl. 3 x SMD-LED, 4,7 W
 3 x 470 lm, 3.000 K



473190307
 473190331





ARUNI

Metall, Weiß matt oder Schwarz matt, Holz naturbelassen · metal, white mat or black mat, wood natural finish ·
 métal, blanc mat ou noir mat, bois finition naturelle · metaal, wit mat mat zwart, hout natuurlijke afwerking · metal, estera blanca o estera negra,
 madera acabado natural · metallo, bianco opaco o nero opaco, di legno finitura naturale · metal, alb mat sau negru mat, lemn finisaj natural ·
 metalli, mattavalkoinen tai mattamusta, puu luonnollinen viimeistely · metal, biały mat lub czarny mat, drewno naturalne wykończenie



Strahler · Spot
 ↑ 13,5 x 11 cm, ↗ 15 cm
 excl. 1 x GU10, max. 35 W



801170131
 801170132



Strahler · Spot
 ↔ 28 x 9 cm, ↗ 15 cm
 excl. 2 x GU10, max. 35 W



801100231
 801100232



Strahler · Spot
 ↔ 48 x 9 cm, ↗ 15 cm
 excl. 3 x GU10, max. 35 W



801100331
 801100332



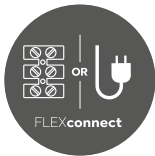
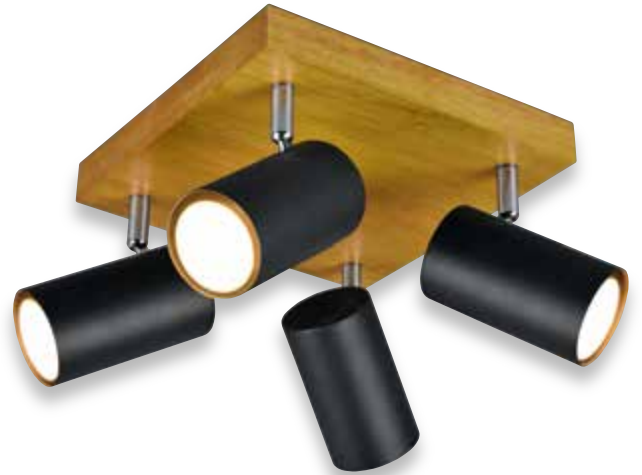
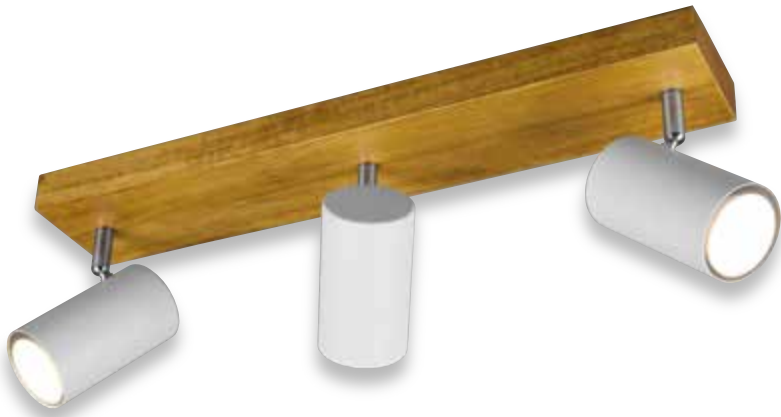

Seite/page 580



Wandleuchte · Wall lamp
 ↔ 12 x 9 cm, ↗ 16 cm
 excl. 1 x GU10, max. 15 W



812400107
 812400131
 812400132



Deckenleuchte · Ceiling lamp
 ↔ 26 x 9 cm, ↓ 16 cm
 excl. 2 x GU10, max. 35 W



812400207
 812400231
 812400232



Deckenleuchte · Ceiling lamp
 ↔ 44 x 9 cm, ↓ 16 cm
 excl. 3 x GU10, max. 35 W



812400307
 812400331
 812400332



Deckenleuchte · Ceiling lamp
 ↔ 22 x 22 cm, ↓ 16 cm
 excl. 4 x GU10, max. 35 W



812400407
 812400431
 812400432



MARLEY

Metall, Holz · metal, wood ·
 metale, bois · metaal, hout · metal, madera ·
 metallo, di legno · metal, lemn · metalli, puu · metal, drewno

Empfohlen:
 recommended: LED GU10, 4,5 W
 345 lm, 3.000 K



956-55



07 | Nickel matt · nickel mat



31 | Weiß matt · white mat



32 | Schwarz matt · black mat



Empfohlen:
recommended: LED GU10, 4,5 W
345 lm, 3.000 K



956-55

MARLEY

Metall, Schwarz-Gold · metal, black-gold ·
métal, noir et or · metaal, zwart-goud · metal, negro-oro ·
metallo, oro nero · metal, negru-auriu · metalli, musta-kulta · metal, czarno złoty



Strahler · Spot

↑ 12 x 12 cm, ↗ 15 cm
excl. 1 x GU10, max. 25 W



802400180



Strahler · Spot

↔ 30 x 9 cm, ↓ 15 cm
excl. 2 x GU10, max. 35 W



802400280



Strahler · Spot

↔ 48 x 9 cm, ↓ 15 cm
excl. 3 x GU10, max. 35 W



802400380



Strahler · Spot

↔ 24 x 24 cm, ↓ 15 cm
excl. 4 x GU10, max. 35 W



802430480

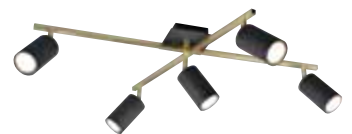

Strahler · Spot

↔ 77,4 x 57,4 cm, ↓ 22,4 cm
excl. 5 x GU10, max. 35 W



612400580





Strahler · Spot
 ↓ 12 x 12 cm, ↗ 15 cm
 excl. 1 x GU10, max. 25 W



- 802400101
- 802400104
- 802400107
- 802400124
- 802400132



Strahler · Spot
 ↔ 30 x 9 cm, ↓ 15 cm
 excl. 2 x GU10, max. 35 W



- 802400201
- 802400204
- 802400207
- 802400224
- 802400232



Strahler · Spot
 ↔ 48 x 9 cm, ↓ 15 cm
 excl. 3 x GU10, max. 35 W



- 802400301
- 802400304
- 802400307
- 802400324
- 802400332



Strahler · Spot
 ↔ 77,4 x 57,4 cm, ↓ 22,4 cm
 excl. 5 x GU10, max. 35 W



- 612400501
- 612400504
- 612400507
- 612400532



Empfohlen:
recommended: LED GU10, 4,5 W
345 lm, 3.000 K



956-55

MARLEY

Metall · metal ·
metale · metaal · metal · metallo · metal · metalli · metal



01 | Weiß · white



04 | Altmessing · old brass



07 | Nickel matt · nickel mat



24 | rostfarbig · rusty



32 | Schwarz matt · black mat



Wandleuchte · Wall lamp
↑ 18 x 6 cm, ↗ 8 cm
excl. 2 x GU10, max. 35 W



212400201
212400204
212400207
212400224
212400232



Strahler · Spot
↔ 24 x 24 cm, ↓ 15 cm
excl. 4 x GU10, max. 35 W



802430401
802430404
802430407
802430424
802430432



Empfohlen:
recommended: LED GU10, 4,5 W
345 lm, 3.000 K



956-55

LEON

Metall, schwarz matt · metal, black mat ·
metale, noir mat · metaal, mat zwart · metal, estera negra · metallo, nero opaco ·
metal, negru mat · metalli, mattamusta · metal, czarny mat



Strahler · Spot
↔ 11 x 16 cm, ∅ 19 cm
excl. 1 x GU10, max. 35 W



800700132



Strahler · Spot
↔ 28 x 16 cm, ∅ 19 cm
excl. 2 x GU10, max. 35 W



800700232



Strahler · Spot
↔ 44 x 16 cm, ∅ 19 cm
excl. 3 x GU10, max. 35 W



800700332



Strahler · Spot
↔ 60 x 16 cm, ∅ 19 cm
excl. 4 x GU10, max. 35 W



800700432





MICHAEL

Nickel matt · nickel mat ·
nickel mat · nikkelt mat · níquel mate · nichel opaco ·
nichel mat · harjattu teräs · nikiel mat · mat nikel



Strahler · Spot
↑ 10,6 x 6 cm, ↗ 13 cm
excl. 1 x GU10, max. 28 W



803000107



Strahler · Spot
↔ 32 x 5 cm, ↓ 13 cm
excl. 2 x GU10, max. 28 W



803000207



Strahler · Spot
↔ 54 x 5 cm, ↓ 13 cm
excl. 3 x GU10, max. 28 W



803000307



Strahler · Spot
Ø 25,5 cm, ↓ 15 cm
excl. 3 x GU10, max. 28 W



803090307



PAGO

Metall, Weiß matt oder Schwarz matt · metal, white mat or black mat ·
 metal, blanc mat ou noir mat · metaal, wit mat of mat zwart ·
 metal, estera blanca o estera negra · metallo, bianco opaco o nero opaco ·
 metal, alb mat sau negru mat · metalli, valkoinen matto tai musta matto ·
 metal, biały mat lub czarny mat



31 | Weiß matt ·
white mat



Strahler · Spot
 Ø 10 cm, ∠ 15 cm
 excl. 1 x GU10, max. 35 W



803500131
803500132



Strahler · Spot
 ↔ 24 x 7 cm, ↓ 15 cm
 excl. 2 x GU10, max. 35 W



803500231
803500232



Strahler · Spot
 ↔ 41 x 7 cm, ↓ 15 cm
 excl. 3 x GU10, max. 35 W



803500331
803500332



32 | Schwarz matt ·
black mat



Strahler · Spot
 ↔ 33 cm, ↓ 19 cm
 incl. 2 x LED E14, 6 W
 2 x 470 lm, 3.000 K

871010207
 871010208



Strahler · Spot
 ↔ 55 cm, ↓ 19 cm
 incl. 3 x LED E14, 6 W
 3 x 470 lm, 3.000 K

871010307
 871010308



Strahler · Spot
 ↔ 88 cm, ↓ 19 cm
 incl. 4 x LED E14, 6 W
 4 x 470 lm, 3.000 K

871010407
 871010408



Strahler · Spot
 ↔ 180 cm, ↓ 21 cm
 incl. 6 x LED E14, 6 W
 6 x 470 lm, 3.000 K

871010607
 871010608



LEVISTO

Nickel matt oder Messing matt, Glas alabasterfarbig ·
 nickel mat or brass mat, alabaster-coloured glass · nickel mat ou laiton mat, verre couleur albâtre · nickel mat of messing mat, albastkleurig glas ·
 níquel mate o bronze mate, vidrio de color alabastro · nichel opaco o ottone satinato, vetro colore alabastro · nichel mat sau bronz mat, sticla
 culoare alabastru · harjattu teräs tai mattamessinki, lasi alabasteri väri · nikiel mat lub mosiądz mat, szkło alabaster kolor



07 | Nickel matt · nickel mat



Strahler · Spot
 Ø 10 cm, ↗ 19 cm
 incl. 1 x LED E14, 6 W
 470 lm, 3.000 K



08 | Messing matt · brass mat



Strahler · Spot
 Ø 30 cm, ↓ 21 cm
 incl. 3 x LED E14, 6 W
 3 x 470 lm, 3.000 K

871010107
 871010108

871090307
 871090308



Empfohlen:
recommended: Filament LED E14, 4 W
470 lm, 2.700 K



983-400



Strahler · Spot
↓ 22,7 cm, ↔ 10 cm, ↗ 15,7 cm
excl. 1 x E14, max. 10 W



811900131
811900132



Strahler · Spot
↔ 40 x 13,8 cm, ↓ 22,8 cm
excl. 2 x E14, max. 10 W



811900231
811900232



Strahler · Spot
↔ 60 x 13,8 cm, ↓ 22,8 cm
excl. 3 x E14, max. 10 W



811900331
811900332



ROXIE

Metall, weiß matt oder schwarz matt, Chrom · metal, white mat or black mat, chrome ·
 Métal, Blanc mat ou Noir mat, Chrome · Metaal, Wit mat of Mat zwart, Chroom ·
 Metal, Estera blanca o Estera negra, Cromo · Metallo, Bianco opaco o Nero opaco, Cromo ·
 Metal, Alb mat sau Negru mat, Crom · Metalli, mattavalkoinen tai mattamusta, Kromi ·
 Metal, Biały mat lub Czarny mat, Chrom

31 | Weiß matt · white mat



32 | Schwarz matt · black mat



Tischleuchte · Table lamp
 ↓ 43 cm, ↔ 17 cm, ↗ 22,5 cm
 excl. 1 x E14, max. 10 W



511900131
 511900132



Stehleuchte · Floor lamp
 ↓ 155 cm, ↔ 43 cm, ↗ 23 cm
 excl. 2 x E14, max. 10 W



411900231
 411900232

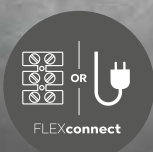

Seite/page 580

Empfohlen:
recommended: Filament LED E14, 4 W
470 lm, 2.700 K



983-400

STEAM

Metall, Weiß antik · metal, antique white ·
Métal, Blanc antique · Metaal, Antiek wit · Metal, Blanco decapé ·
Metallo, Bianco anticato · Metal, Alb antic · Metall, Antiikkivalkoinen ·
Metal, Antyczny biały



Strahler · Spot

↑ 14 cm, ↔ 10 cm, ↗ 19 cm
excl. 1 x E14, max. 10 W



813400127



Strahler · Spot

↔ 30 x 10 cm, ↓ 22 cm
excl. 2 x E14, max. 25 W



813400227



Strahler · Spot

↔ 77 x 10 cm, ↓ 17,5 cm
excl. 4 x E14, max. 25 W



813400427



Strahler · Spot

Ø 28 cm, ↓ 19 cm
excl. 3 x E14, max. 25 W



813430327





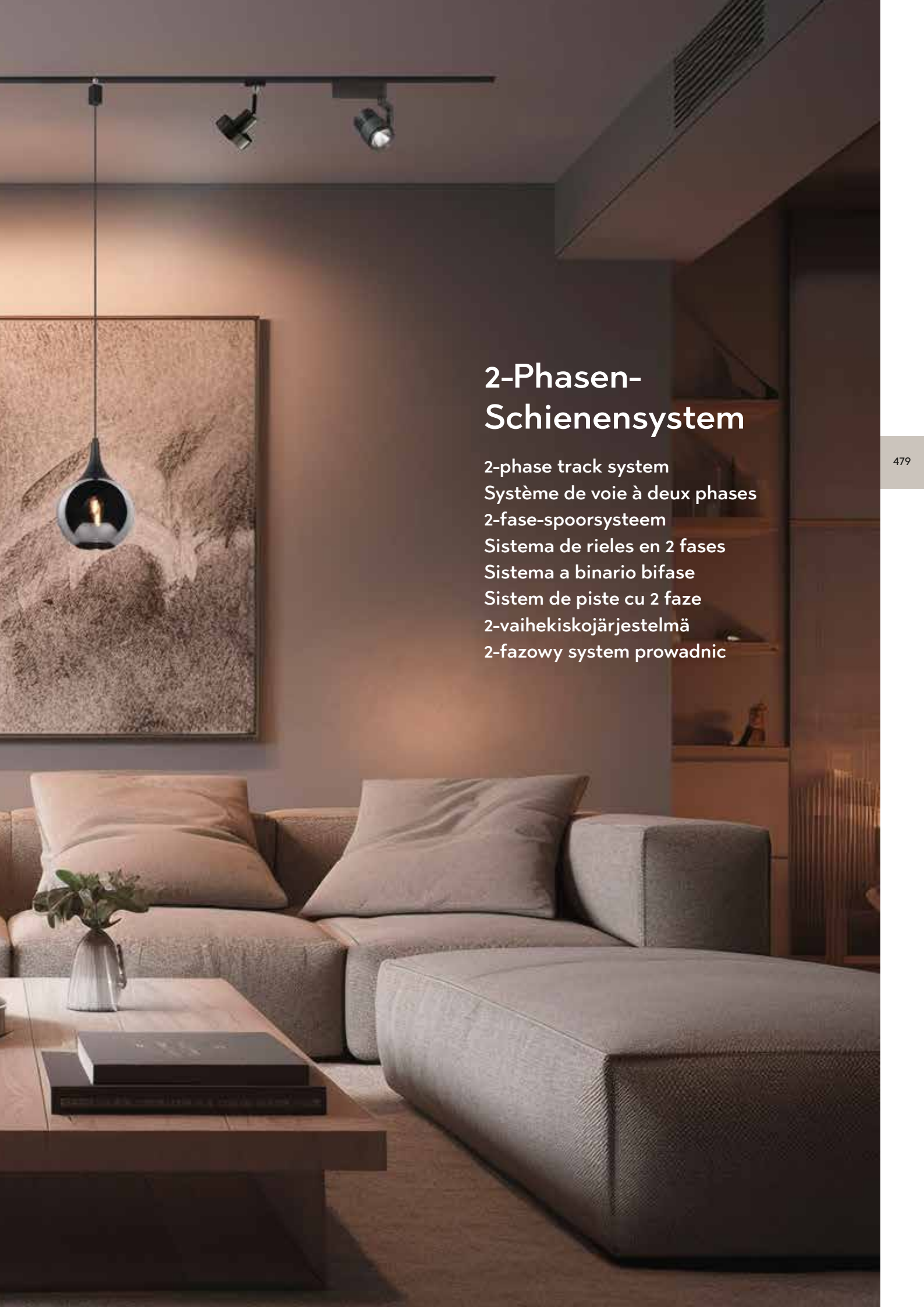

2-Phasen- Schienensystem

2-phase track system

Système de voie à deux phases

2-fase-spoorsysteem

Sistema de rieles en 2 fases

Sistema a binario bifase

Sistem de piste cu 2 faze

2-vaihekiskojärjestelmä

2-fazowy system prowadnic



Für jede Raumsituation die ideale Beleuchtung.

Das DUOline 2-Phasen-Schiensystem ist äußerst flexibel und bietet zahlreiche Möglichkeiten zur individuellen Lichtgestaltung. Die verschiedenen Spots und Pendelleuchten lassen sich frei in der Schiene platzieren und können so gezielt in allen Wohnbereichen eingesetzt werden. Das 2-Phasensystem ermöglicht, dass mit nur einem Stromanschluss zwei Beleuchtungsgruppen getrennt voneinander geschaltet oder gedimmt werden können.

The ideal lighting for every room situation.

The DUOline 2-phase track system is extremely flexible and offers numerous possibilities for individual lighting arrangements. The various spotlights and pendant lamps can be positioned as desired in the track and can therefore be used in all living areas. The 2-phase system allows two lighting groups to be switched or dimmed independently of each other with just one power connection.

L'éclairage parfait pour chaque type de pièces.

Le système de rails biphasés DUOline est extrêmement flexible et offre de nombreuses possibilités de conception individuelle de l'éclairage. Les différents projecteurs et luminaires suspendus peuvent être positionnés librement dans le rail et peuvent donc être utilisés de manière spécifique dans tous vos espaces d'habitation. Le système biphasé permet de commuter ou de faire varier l'intensité de deux groupes d'éclairage séparément l'un de l'autre avec un seul branchement électrique.

Voor elke situatie de ideale verlichting.

Het DUOline-2-fase-spoorsysteem is uiterst flexibel en biedt talrijke mogelijkheden voor een individuele lichtvormgeving. De diverse spots en hanglampen kunnen willekeurig in het spoor geplaatst worden en kunnen zo doelgericht in alle woonruimtes gebruikt worden. Het 2-fase-systeem maakt mogelijk dat met slechts één stroomaansluiting twee verlichtingsgroepen apart van elkaar geschakeld of gedimd kunnen worden.

La iluminación ideal para cada habitación.

El sistema de rieles en 2 fases DUOline es extraordinariamente flexible y ofrece numerosas posibilidades de diseño lumínico individuales. Los distintos puntos y lámparas de péndulo le permiten colocar los rieles libremente y por eso pueden utilizarse en toda la vivienda. El sistema de rieles en 2 fases permite que se activen o atenúen dos grupos de lámparas separados con un solo cable de corriente.

L'illuminazione ideale per qualsiasi esigenza abitativa.

Il sistema a binario bifase DUOline è estremamente flessibile e offre numerose possibilità per la progettazione individuale dell'illuminazione. I vari faretti e lampade a sospensione possono essere posizionati liberamente nel binario e possono quindi essere utilizzati in modo specifico in tutti gli ambienti abitativi. Il sistema bifase consente di commutare o dimmerare due gruppi di illuminazione separatamente l'uno dall'altro con una sola connessione di alimentazione.

Iluminatul ideal pentru fiecare încăpere.

Sistemul de piste cu 2 faze DUOline este deosebit de flexibil și oferă numeroase posibilități pentru structurarea individuală a luminii. Diferitele spot-uri și lustre pot fi amplasate liber pe pistă și pot fi astel utilizate țintit în toate zonele spațiilor de locuit. Sistemul cu 2 faze permite comutarea și reglarea intensității pentru două grupuri de corpuri de iluminat separate, folosind un singur racord electric.

Ihanteellinen valaistus jokaiseen huoneen käyttötilanteeseen.

DUOline 2-vaihekiskojärjestelmä on erittäin joustava ja tarjoaa lukuisia vaihtoehtoja yksilölliseen valaistuksen suunnitteluun. Eri spotti- ja ripustettavat valaisimet voidaan sijoittaa mihin tahansa kiskoon, joten niitä voidaan käyttää kaikissa asuintiloissa. 2-vaihejärjestelmä mahdollistaa kahden valaistusryhmän kytkemisen tai himmentämisen erikseen yhdellä sähköliitännällä.

Idealne oświetlenie do każdej sytuacji w pomieszczeniu.

Dwufazowy system prowadnic DUOline jest niezwykle elastyczny i oferuje wiele opcji indywidualnego projektowania oświetlenia. Różne skupienia i lampy wiszące można umieścić w dowolnym miejscu na szynie, dzięki czemu można je stosować we wszystkich pomieszczeniach mieszkalnych. System 2-fazowy umożliwia osobne przełączanie lub przyciemnianie dwóch grup oświetlenia za pomocą tylko jednego podłączenia zasilania.

ÜBERSICHT KOMPONENTEN

Component overview · Aperçu des composants · Overzicht van componenten ·
Vista general por componentes · Panoramica dei componenti ·
Prezentare generală a componentelor · Komponentteihin yleiskuvaus ·
Przegląd komponentów

482

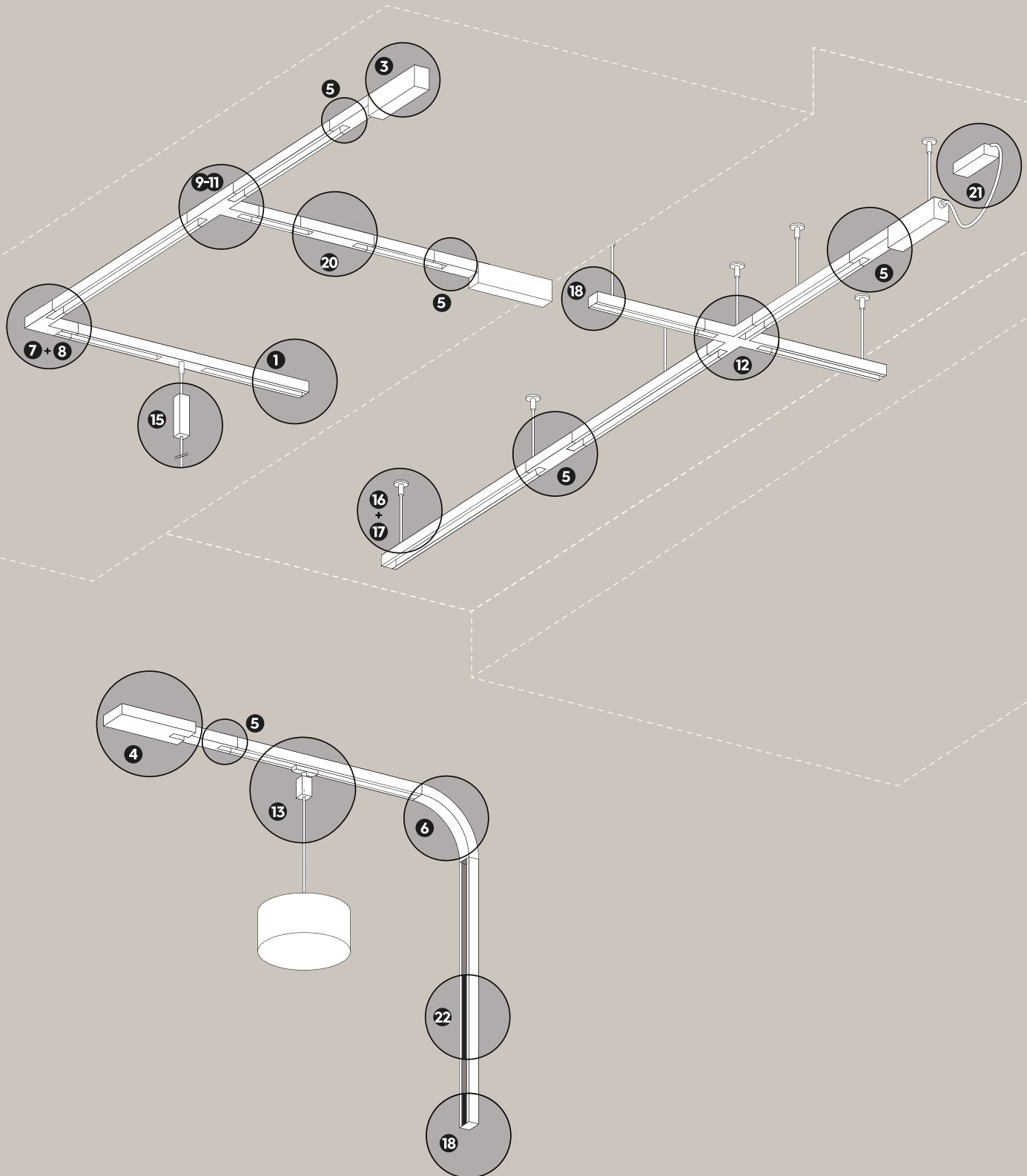

Die Vorteile von DUOline im Überblick:

- Individuelle Lichtgestaltung
- Nur ein Stromanschluss erforderlich
- Kein Trafo notwendig
- Leuchten frei kombinierbar und leicht versetzbar
- Zwei verschiedene Lichtszenarien
- Getrenntes Schalten und Dimmen
- Für Decken- und Wandmontage geeignet

Advantages of DUOline at a glance:

- individual lighting arrangements
- only one power connection required
- no need for a transformer
- lamps can be freely combined and are easily positioned
- two different lighting scenarios
- separate switching and dimming
- suitable for ceilings and walls

Les avantages de DUOline en un coup d'œil :

- Conception individuelle de l'éclairage
- Une seule connexion électrique requise
- Pas besoin de transformateur
- Les luminaires peuvent être librement combinés et facilement déplacés
- Deux scénarios lumineux différents
- Commutation et variateur de lumière séparés
- Convient pour le montage au plafond et au mur

Overzicht van de voordelen van DUOline:

- Individuele lichtvormgeving
- Slechts één stroomaansluiting nodig
- Geen transformator nodig
- Lampen willekeurig combineerbaar en gemakkelijk verplaatsbaar
- Twee verschillende lichtscenario's
- Apart schakelen en dimmen
- Geschikt voor plafond- en muurmontage

Las ventajas de DUOline en resumen:

- Diseño lumínico individual
- Solo un cable de corriente necesario
- Ningún transformador necesario
- Lámpara combinables libremente y fácilmente desplazable
- Dos escenarios lumínicos diferentes
- Activación y atenuación separadas
- Adecuado para su montaje en techo y pared

I vantaggi di DUOline in sintesi:

- Progettazione individuale dell'illuminazione
- È necessario un solo collegamento di alimentazione
- Non è necessario alcun trasformatore
- Le lampade possono essere liberamente combinate e facilmente spostate
- Due differenti scenari di illuminazione
- Commutazione e dimmerazione separate
- Adatto per il montaggio a soffitto e a parete

Avantajele DUOline dintr-o privire:

- Structurarea individualizată a luminii
- Este necesară o singură conexiune electrică
- Nu este necesar un transformator
- Lămpile pot fi combinate liber și pot fi deplasate cu ușurință
- Două scenarii de iluminat diferite
- Comutare și reglare a intensității separate
- Adecvat pentru montajul pe plafon și pe perete

DUOlinen edut lyhyesti:

- Yksilöllinen valaistussuunnittelu
- Vaaditaan vain yksi sähköliitäntä
- Muuntajaa ei tarvita
- Valaisimia voidaan yhdistellä vapaasti ja siirtää helposti
- Kaksi erilaista valaistusskenaariota
- Erillinen kytkentä ja himmennys
- Sopii katto- ja seinäasennukseen

Zalety DUOline w skrócie:

- Indywidualny projekt oświetlenia
- Wymagane jest tylko jedno połączenie zasilania
- Nie wymaga transformatora
- Oprawy można dowolnie łączyć i łatwo przemieszczać
- Dwa różne scenariusze oświetlenia
- Oddzielne włączanie i ściemnianie
- Nadaje się do montażu sufitowego i ściennego

SCHIENE · TRACK



31



32



87

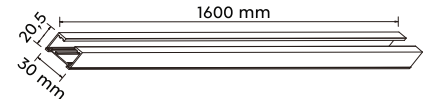
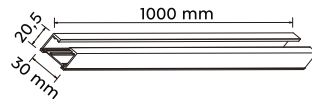
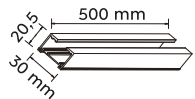

1 SCHIENE 50 CM · TRACKING 50 CM

Metall · metal

- 700131 | Weiß matt · white mat
- 700132 | Schwarz matt · black mat
- 700187 | titanfarbig · titan

SCHIENE 100 CM · TRACKING 100 CM

Metall · metal

- 700231 | Weiß matt · white mat
- 700232 | Schwarz matt · black mat
- 700287 | titanfarbig · titan

SCHIENE 160 CM · TRACKING 160 CM

Metall · metal

- 700331 | Weiß matt · white mat
- 700332 | Schwarz matt · black mat
- 700387 | titanfarbig · titan

Die maximale Montagelänge beträgt 30 Meter pro Einspeisung, bei einer Gesamtleistung von max. 600 Watt pro Phase.
The maximum installation length is 30 metres per power feed, with a total capacity of max. 600 watts per phase.

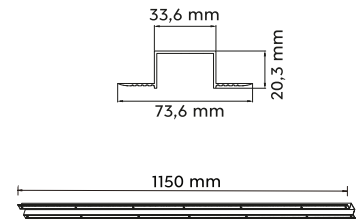
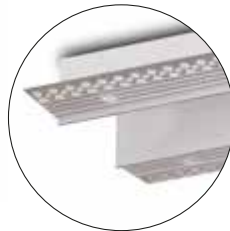

2 EINBAUPROFIL 115 CM · RECESSED PROFILE 115 CM

Metall · metal

703809 | aluminiumfarbig · aluminium



Mit diesem Einbauprofil als Zubehör können die Stromschienen anstelle der Aufputz-Montage bündig in der Decke montiert werden.
With this recessed profile as an accessory, the power tracks can be mounted flush in the ceiling instead of surface mounting.



EINSPEISUNG · POWER SUPPLY



31



32



87

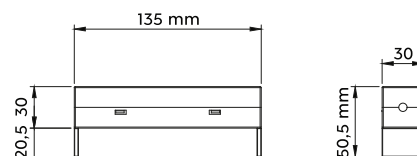

3 MITTEL-/END-EINSPEISUNG · MIDDLE-/ENDPOINT POWER SUPPLY

Kunststoff · plastic
max. 2 x 600 W

701031 | Weiß matt · white mat

701032 | Schwarz matt · black mat

701087 | titanfarbig · titan

Die Mittel-/Endeinspeisung wird direkt über dem Stromauslass angebracht und ermöglicht, Schienen auf einer Seite oder auf beiden Seiten anzuschließen.
Zur Stromversorgung der Schienen wird immer ein Verbinder benötigt.

The middle/end feed is mounted directly over the power outlet and enables tracks to be connected on one or both sides.
A connector is always required to power the rails.



31



32



87

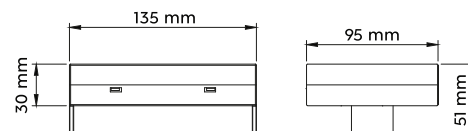

4 MITTEL-/END-EINSPEISUNG MIT ELEKTRONISCHEM PHASENWECHSLER · MIDDLE-/ENDPOINT POWER SUPPLY WITH ELECTRONIC PHASE CHANGER

Kunststoff · plastic
max. 2 x 200 W

701131 | Weiß matt · white mat

701132 | Schwarz matt · black mat

701187 | titanfarbig · titan

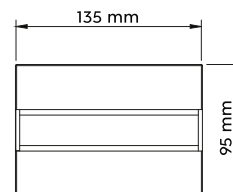

Mittels elektronischem Phasenwechsler lassen sich die zwei Phasen auch bei dreidadrigen Stromleitungen getrennt Schalten und Dimmen.
Zur Stromversorgung der Schienen wird immer ein Verbinder benötigt.

Using an electronic phase changer, the two phases can be switched and dimmed separately, even with three-core power cables.
A connector is always required to power the rails.

VERBINDER · CONNECTOR



31



32



87

5 LÄNGSVERBINDER · LINE CONNECTOR

Kunststoff · plastic
max. 2 x 600 W

702131 | Weiß matt · white mat
702132 | Schwarz matt · black mat
702187 | titanfarbig · titan

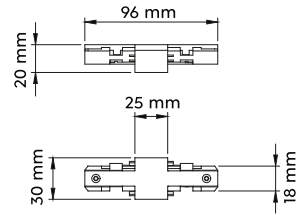

Verbindet zwei Schienen für gerade Strecken miteinander.
Connects two rails together for straight sections.



31



32



87

6 FLEX-VERBINDER · FLEX CONNECTOR

Kunststoff · plastic
max. 2 x 600 W

702031 | Weiß matt · white mat
702032 | Schwarz matt · black mat
702087 | titanfarbig · titan

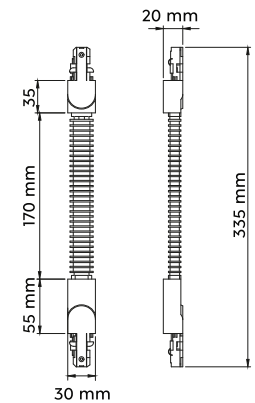

Verbindet zwei Schienen in einem beliebigen Winkel miteinander und ermöglicht die Verbindung zwischen Decken- und Wandmontage.
Connects two rails together at any angle and makes possible a connection between ceiling and wall mounting.



31



32



87

7 L-VERBINDER - SCHUTZLEITER INNEN · L-CONNECTOR - INNER PROTECTIVE CONDUCTOR

Kunststoff · plastic
max. 2 x 600 W

702231 | Weiß matt · white mat
702232 | Schwarz matt · black mat
702287 | titanfarbig · titan

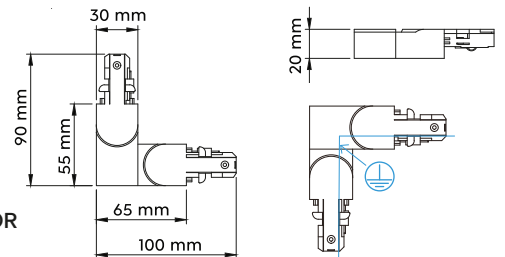

8 L-VERBINDER (TYP A) - SCHUTZLEITER AUSSEN · L-CONNECTOR (TYPE A) - OUTER PROTECTIVE CONDUCTOR

Kunststoff · plastic
max. 2 x 600 W

702231A | Weiß matt · white mat
702232A | Schwarz matt · black mat
702287A | titanfarbig · titan

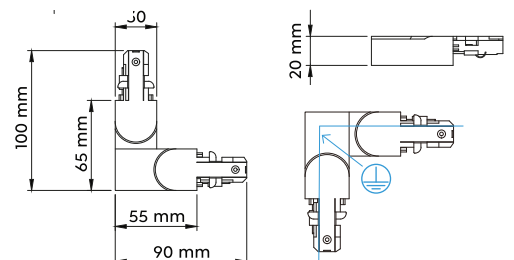

Verbindet zwei Schienen im rechten Winkel miteinander.
Connects two rails together at right angles.



31



32



87

9 T-VERBINDER - SCHUTZLEITER RECHTS · T-CONNECTOR - RIGHT PROTECTIVE CONDUCTOR

Kunststoff · plastic
max. 2 x 600 W

- 702331 | Weiß matt · white mat
- 702332 | Schwarz matt · black mat
- 702387 | titanfarbig · titan

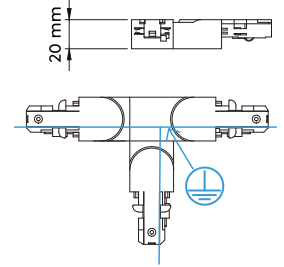
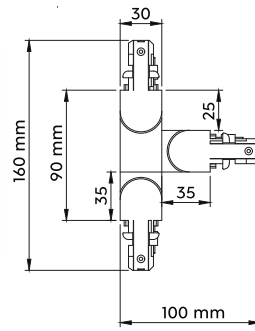

31



32



87

10 T-VERBINDER (TYP A) - SCHUTZLEITER LINKS · T-CONNECTOR (TYPE A) - LEFT PROTECTIVE CONDUCTOR

Kunststoff · plastic
max. 2 x 600 W

- 702331A | Weiß matt · white mat
- 702332A | Schwarz matt · black mat
- 702387A | titanfarbig · titan

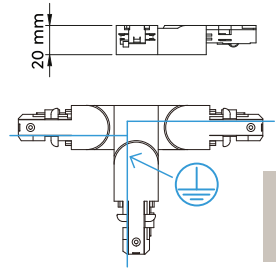
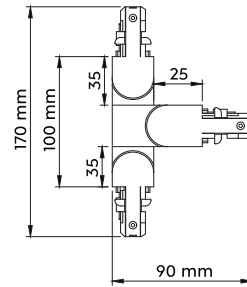

31



32



87

11 T-VERBINDER (TYP B) - SCHUTZLEITER LINKS · T-CONNECTOR (TYPE B) - LEFT PROTECTIVE CONDUCTOR

Kunststoff · plastic
max. 2 x 600 W

- 702331B | Weiß matt · white mat
- 702332B | Schwarz matt · black mat
- 702387B | titanfarbig · titan

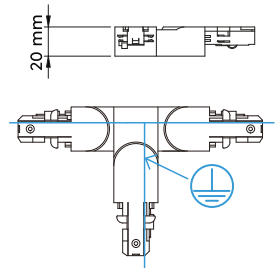
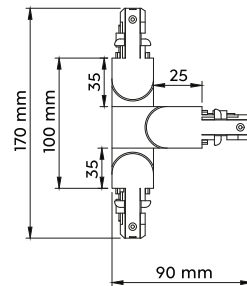

Verbindet drei Schienen im rechten Winkel miteinander.
Connects three rails together at right angles.



31



32



87

12 X-VERBINDER · X-CONNECTOR

Kunststoff · plastic
max. 2 x 600 W

- 702431 | Weiß matt · white mat
- 702432 | Schwarz matt · black mat
- 702487 | titanfarbig · titan

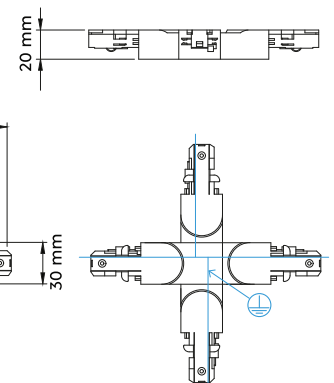
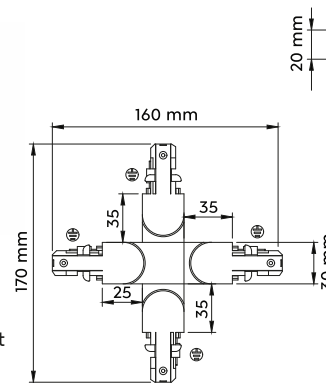

Verbindet vier Schienen im rechten Winkel miteinander.
Connects four tracks together at right angles to each other.

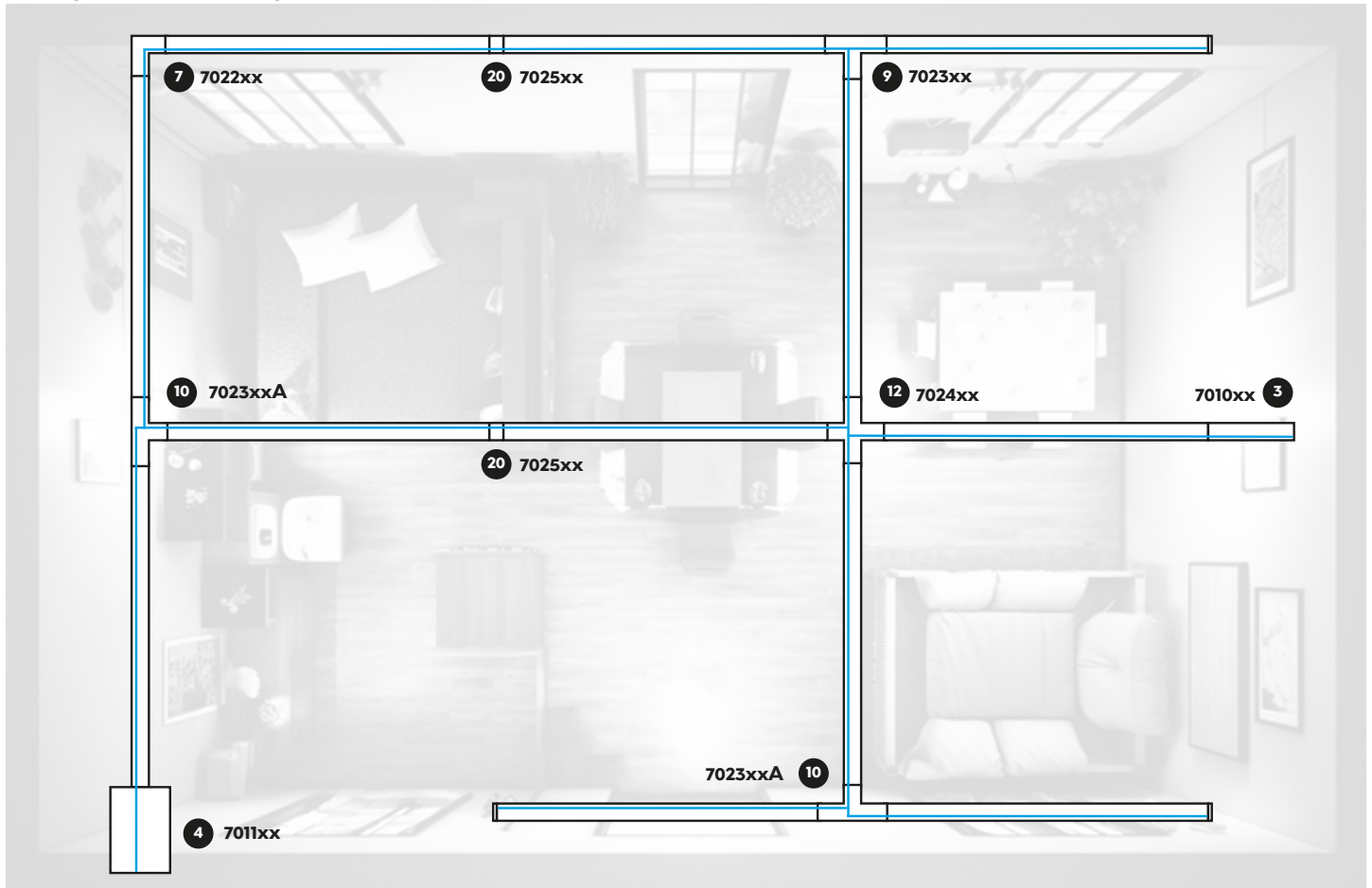
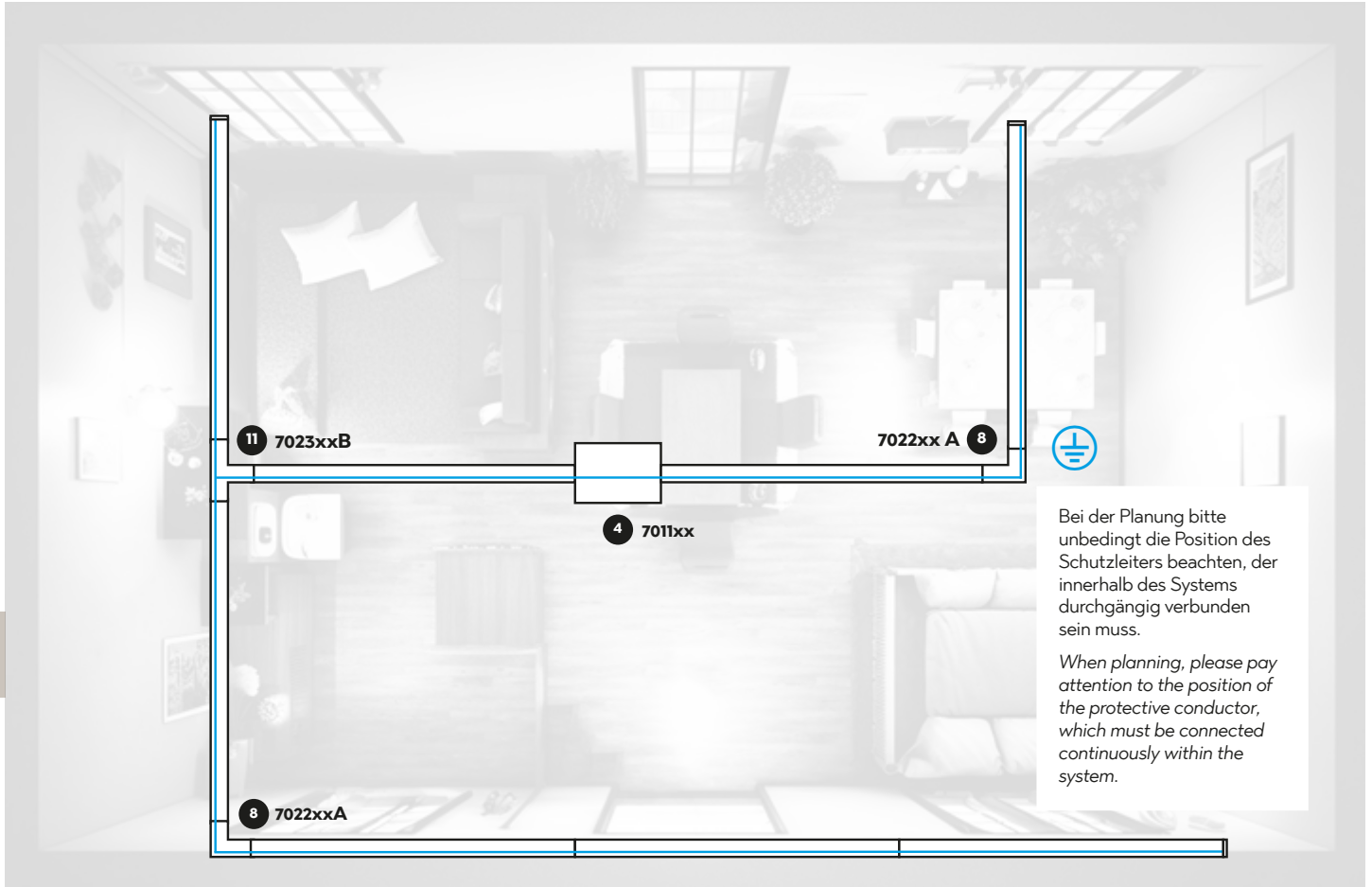

Die Komponenten sind so eingezeichnet, wie sie an der Decke/Wand montiert werden sollen.
Ansicht der Komponenten von oben auf der Montageseite.
 The components are drawn in as they are to be mounted on the ceiling/wall.
View of the components from above on the mounting side.



ZUBEHÖR · ACCESSORIES

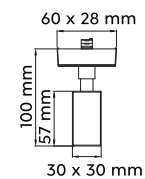

13 PENDEL-ADAPTER · PENDULAR ADAPTER

Kunststoff · plastic
max. 60 W

703631 | Weiß matt · white mat
703632 | Schwarz matt · black mat
703687 | titanfarbig · titan

Dieser Pendel-Adapter ermöglicht es, herkömmliche Pendelleuchten in das DUOline Schienensystem zu integrieren.
This pendular adapter makes it possible for conventional pendular lamps to be integrated into the DUOline track system.

489

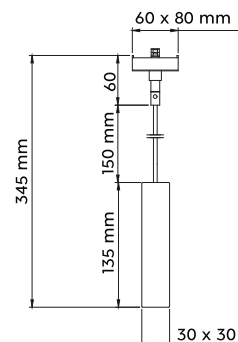
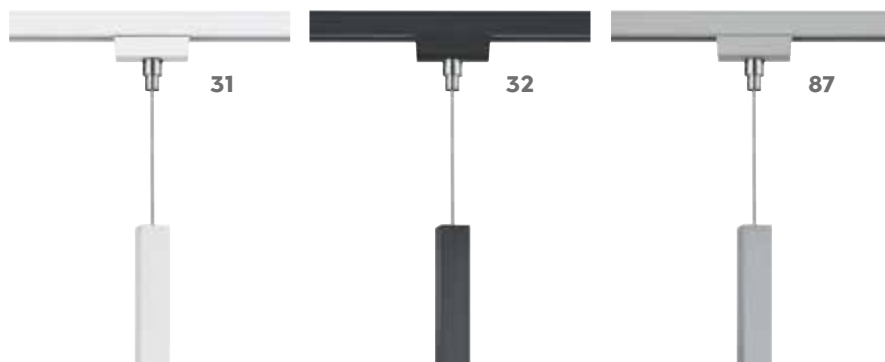

14 PENDEL-ADAPTER · PENDULAR ADAPTER

Kunststoff · plastic
max. 60 W

703531 | Weiß matt · white mat
703532 | Schwarz matt · black mat
703587 | titanfarbig · titan

Dieser Pendel-Adapter ermöglicht es, herkömmliche Pendelleuchten in das DUOline Schienensystem zu integrieren.
This pendular adapter makes it possible for conventional pendular lamps to be integrated into the DUOline track system.

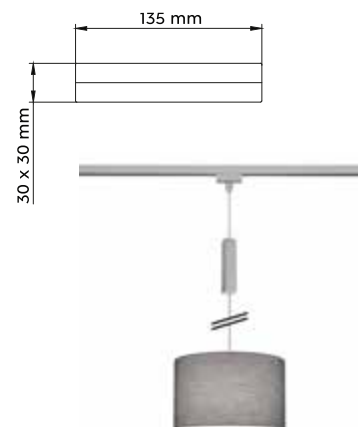

15 KABELKÜRZER · CABLE SHORTENER

Kunststoff · plastic

703331 | Weiß matt · white mat
703332 | Schwarz matt · black mat
703387 | titanfarbig · titan

Ermöglicht das Kürzen der Kabel von Pendelleuchten.
Makes a shortening of the pendal lamp cable possible.



31



32



87

16 DISTANZHALTER SET · SUSPENSION SET

Kunststoff · plastic

- 703131 | Weiß matt · white mat
- 703132 | Schwarz matt · black mat
- 703187 | titanfarbig · titan

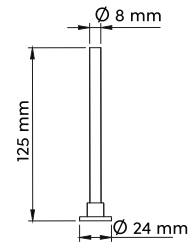

31



32



87

17 DISTANZHALTER SET · SUSPENSION SET

Kunststoff · plastic

- 703231 | Weiß matt · white mat
- 703232 | Schwarz matt · black mat
- 703287 | titanfarbig · titan

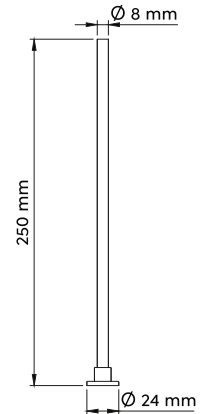

31



32



87

18 ENDKAPPEN · END CAPS

Kunststoff · plastic

- 703031 | Weiß matt · white mat
- 703032 | Schwarz matt · black mat
- 703087 | titanfarbig · titan

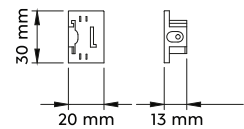

31



32



87

19 AUSTAUSCHCOVER FÜR ADAPTER · EXCHANGE COVER FOR ADAPTER

Kunststoff · plastic

- 703731 | Weiß matt · white mat
- 703732 | Schwarz matt · black mat
- 703787 | titanfarbig · titan

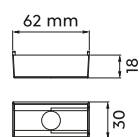



31



32



87

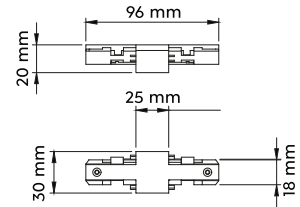

20 ISOLATOR · ISOLATOR

Kunststoff · plastic
max. 2 x 600 W

702531 | Weiß matt · white mat
702532 | Schwarz matt · black mat
702587 | titanfarbig · titan

Mittels Isolator können zwei separate Schaltkreise optisch zu einem System verbunden werden.
Using an isolator, two separate circuits can be optically connected to form one system.



31



32



87

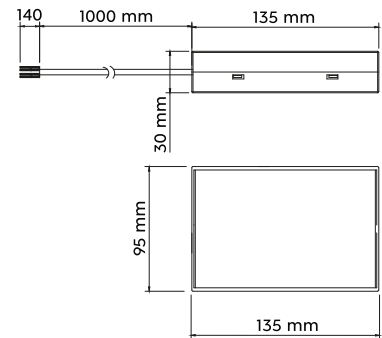

21 FLEXIBLE STROMVERSORGUNG · FLEX POWER SUPPLY

Kunststoff · plastic
max. 2 x 600 W

701231 | Weiß matt · white mat
701232 | Schwarz matt · black mat
701287 | titanfarbig · titan

Die flexible Stromversorgung wird benötigt, wenn die Schienen nicht direkt über den Stromauslass verlegt werden können.
Nur in Verbindung mit einer Mittel-/Endeinspeisung.
The flexible power supply is required if the rails cannot be mounted directly over the power outlet.
Only in use with a middle-/endpoint power supply.

22 ABDECKSCHIENE · SAFETY COVER STRIP

Kunststoff · plastic
↔ 100 x 1,4 cm, ∟ 0,5 cm

703952 | Transparent · transparent



23 ABDECKPLATTE · COVER PLATE

Metall · metal
↑ 0,1 cm, Ø 1 cm

703431 | Weiß matt · white mat



RADIATOR

Metall · metal · metale · metaal · metal · metallo · metal · metalli · metal



31



32



87

STRAHLER · SPOT
incl. SMD-LED, 15 W
1.270 lm, 2.300 + 3.000 + 4.000 K



78030131 | Weiß matt · white mat
78030132 | Schwarz matt · black mat
78030187 | titanfarbig · titan

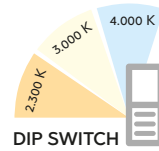
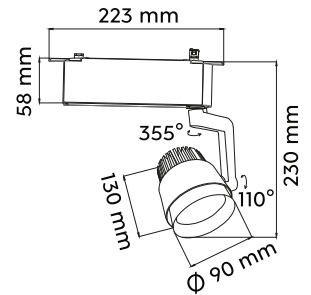

492

LEON

Metall · metal · metale · metaal · metal · metallo · metal · metalli · metal



07



31



32

STRAHLER · SPOT
excl. 1 x GU10, max. 25 W



78070107 | Nickel matt · nickel mat
78070131 | Weiß matt · white mat
78070132 | Schwarz matt · black mat

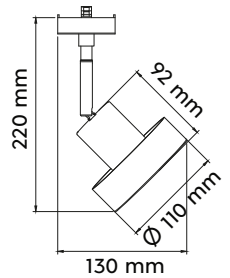

Empfohlen:
recommended: LED GU10, 5 W
400 lm, 3.000 K



956-5936

ROUBAIX

Metall · metal · metale · metaal · metal · metallo · metal · metalli · metal



07



31



32

STRAHLER · SPOT
incl. SMD-LED, 4 W
400 lm, 3.000 K



78150107 | Nickel matt · nickel mat
78150131 | Weiß matt · white mat
78150132 | Schwarz matt · black mat

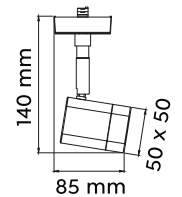





MARLEY

Metall · metal · metale · metaal · metal · metallo · metal · metalli · metal



07



08



31



32

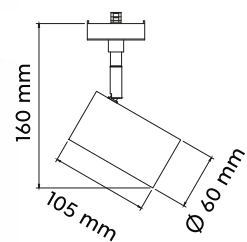

STRAHLER · SPOT

excl. 1 x GU10, max. 25 W



- 78240107 | Nickel matt · nickel mat
- 78240108 | Messing matt · brass mat
- 78240131 | Weiß matt · white mat
- 78240132 | Schwarz matt · black mat



07



08



31



32

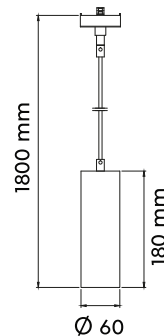

PENDELLEUCHTE · PENDANT

excl. 1 x GU10, max. 25 W



- 73240107 | Nickel matt · nickel mat
- 73240108 | Messing matt · brass mat
- 73240131 | Weiß matt · white mat
- 73240132 | Schwarz matt · black mat



PAROS

Metall · metal · metale · metaal · metal · metallo · metal · metalli · metal

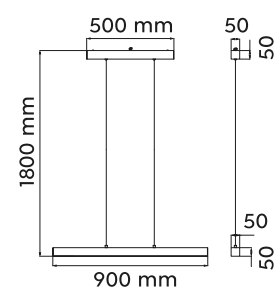

PENDELLEUCHTE · PENDANT

incl. SMD-LED, 29 W
3.400 lm, 3.000 K

73043107 | Nickel matt · nickel mat

73043131 | Weiß matt · white mat

73043132 | Schwarz matt · black mat



ONTARIO

Glas Weiß · glass white · verre blanc ·
glas wit · vidrio blanco · vetro bianco ·
sticla alb · lasi valkoinen · szkło biały

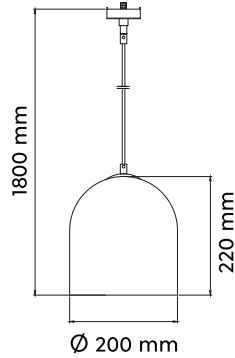

PENDELLEUCHTE · PENDANT
excl. 1 x E14, max. 25 W



73520101 | Weiß · white

ANTIBES

Metall, Glas Weiß · metal, glass white · metale, verre blanc ·
metaal, glas wit · metal, vidrio blanco · metallo, vetro bianco ·
metal, sticla alb · metalli, lasi valkoinen · metal, szkło biały

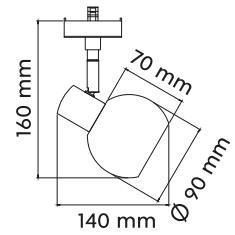

STRAHLER · SPOT
excl. 1 x GU10, max. 25 W



78170107 | Nickel matt · nickel mat

496

LUMINA

Metall, Schwarz matt, Glas chrom bedampft · Metal, black mat, chrome plated glass ·
métal, noir mat, verre plaqué chrome · metaal, mat zwart, chroom opgedampt glas · metal, estera negra, vidrio cromado ·
metallo, nero opaco, vetro verniciato cromo · metal, negru mat, sticla cromata · metalli, mattamusta, kromipäällystetty lasi ·
metal, czarny mat, szkło chromowane

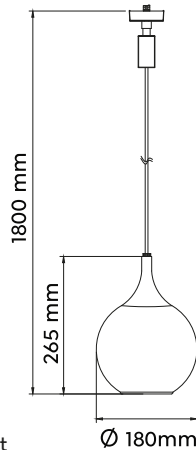

PENDELLEUCHTE · PENDANT
excl. 1 x E14, max. 40 W



73700132 | Schwarz matt · black mat

ROBIN

Metall, Glas · metal, glass ·
metale, verre · metaal, glas · metal, vidrio ·
metallo, vetro · metal, sticla · metalli, lasi · metal, szkło

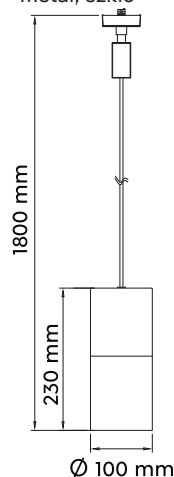

PENDELLEUCHTE · PENDANT
excl. 1 x E27, max. 28 W



73060132 | Schwarz matt · black mat



DIALLO

Metall · metal · metale · metaal · metal · metallo · metal · metalli · metal



07



31



32

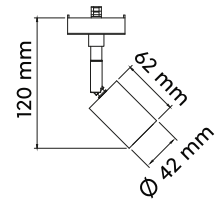

STRAHLER · SPOT
excl. 1 x E27, max. 25 W



78010107 | Nickel matt · nickel mat
78010131 | Weiß matt · white mat
78010132 | Schwarz matt · black mat

TOSH

Metall, Holz · metal, wood · metale, bois · metaal, hout · metal, madera · metallo, di legno · metal, lemn · metalli, puu · metal, drewno

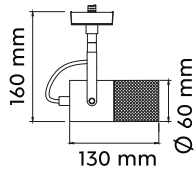

STRAHLER · SPOT
excl. 1 x E14, max. 25 W



78430132 | Schwarz matt · black mat

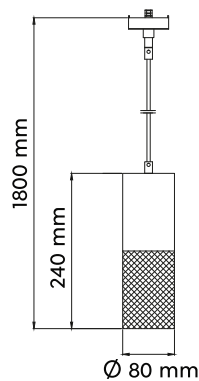

PENDELLEUCHTE · PENDANT
excl. 1 x E27, max. 25 W



73430132 | Schwarz matt · black mat



PANEL

Kunststoff · plastic · plastique · kunststof · plástico · plastica · plastic · muovi · plastik

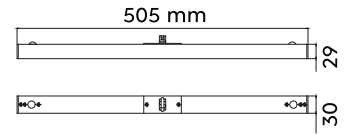

LED-PANEL
incl. SMD-LED, 6 W
850 lm, 3.000 K



- 77020131 | Weiß matt · white mat
- 77020132 | Schwarz matt · black mat
- 77020187 | titanfarbig · titan

CAMILLUS

Kunststoff · plastic · plastique · kunststof · plástico · plastica · plastic · muovi · plastik

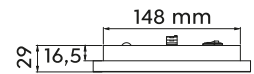

LED-PANEL
incl. SMD-LED, 9 W
900 lm, 3.000 K



- 76921031 | Weiß matt · white mat
- 76921032 | Schwarz matt · black mat
- 76921087 | titanfarbig · titan

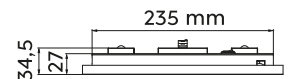

LED-PANEL
incl. SMD-LED, 13 W
1.400 lm, 3.000 K



- 76921531 | Weiß matt · white mat
- 76921532 | Schwarz matt · black mat
- 76921587 | titanfarbig · titan



HOTEL

Stoffschild · fabric shade · abat-jour tissu · Stoffen kap · Pantalla de tela · paralume in tessuto · abajur textil · kangas varjostin · Klosz z materiału



01



11

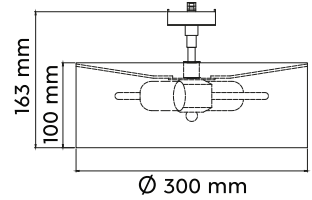

DECKENLEUCHTE · CEILING LAMP

excl. 2 x E27, max. 25 W



76390201 | Weiß · white

76390211 | Grau · grey



01



11

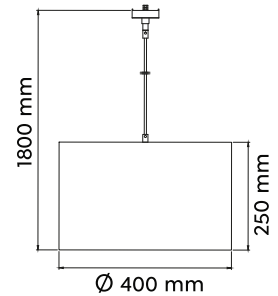

500

PENDELLEUCHTE · PENDANT

excl. 1 x E27, max. 25 W



73330101 | Weiß · white

73330111 | Grau · grey

TOMMY

Stoffschild · fabric shade · abat-jour tissu · Stoffen kap · Pantalla de tela · paralume in tessuto · abajur textil · kangas varjostin · Klosz z materiału



01



11



79

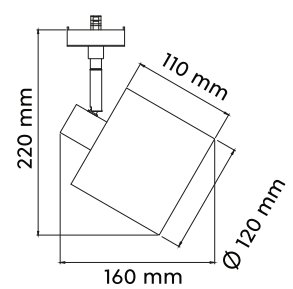

STRAHLER · SPOT

excl. 1 x E14, max. 25 W



78330101 | Weiß · white

78330111 | Grau · grey

78330179 | goldfarbig · gold

JIMMY

Metall, Schwarz · metal, black · metale, noir · metaal, zwart · metal, negro · metallo, nero · metal, negru · metalli, musta · metal, czarny



PENDELLEUCHTE · PENDANT

excl. 1 x E27, max. 25 W



73120102 | Schwarz-Gold · black-gold

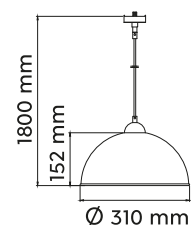



HOSTEL

Stoffschirm · fabric shade · abat-jour tissu · Stoffen kap · Pantalla de tela · paralume in tessuto · abajur textil · kangas varjostin · Klosz z materiału

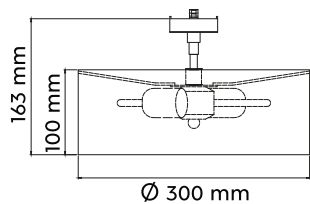

DECKENLEUCHTE · CEILING LAMP

excl. 2 x E27, max. 25 W

76820280 | Schwarz-Gold · black-gold

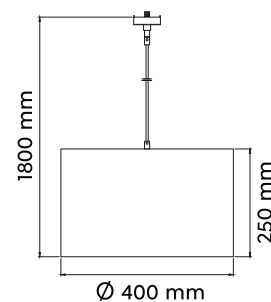

PENDELLEUCHTE · PENDANT

excl. 1 x E27, max. 25 W

73820180 | Schwarz-Gold · black-gold



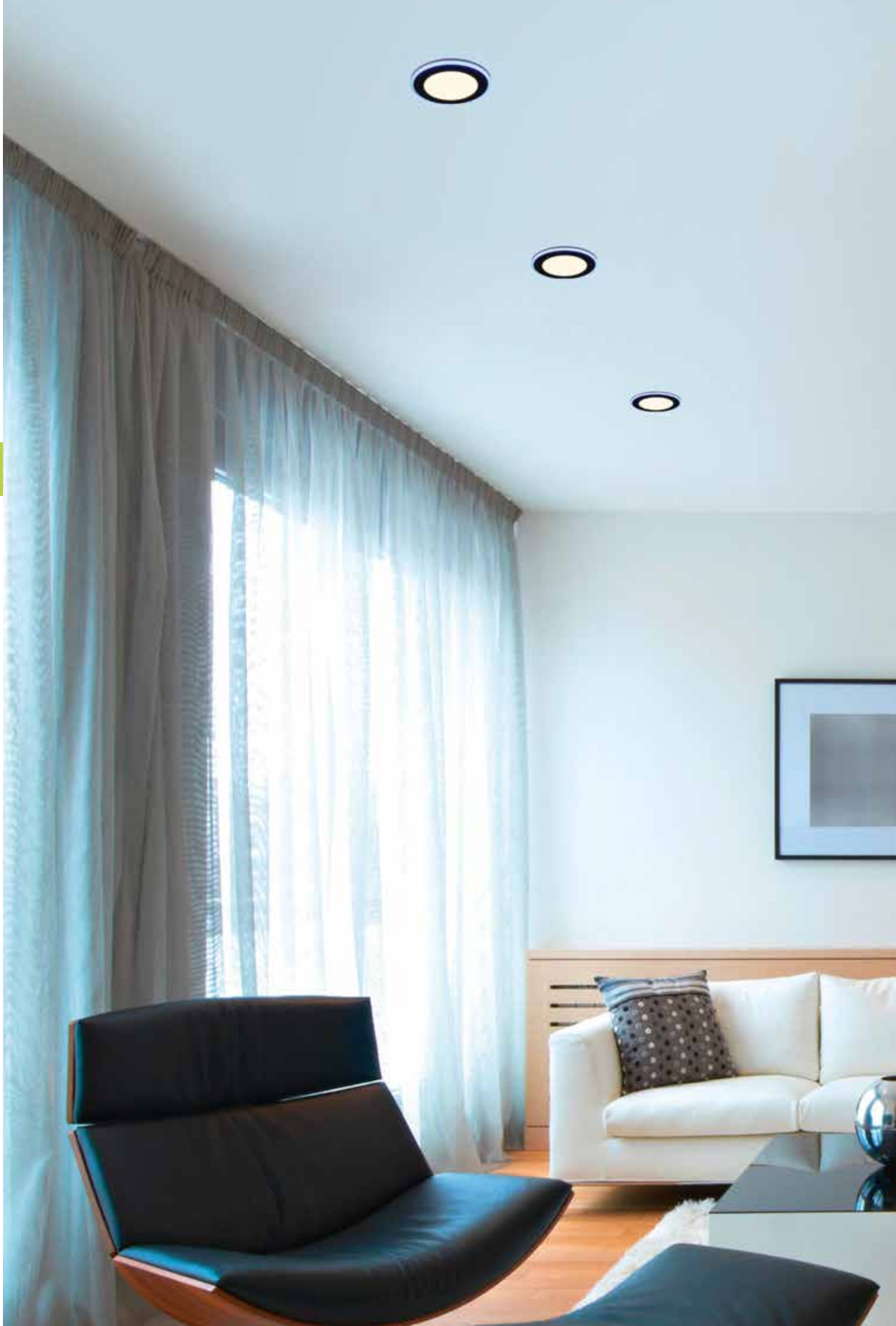



Einbauleuchten

- Recessed lights
- Spots encastrés
- Inbouwspots
- Focos empotrables
- Faretti incasso
- Spoturi incastrate
- Upotetut spotit
- Oprawy wbudowane

AURA

Kunststoff, Chrom, Weiß matt oder Schwarz matt · plastic, chrome, white mat or black mat ·
 plastique, chrome, blanc mat ou noir mat · kunststof, chroom, wit mat of mat zwart · plástico, cromo, estera blanca o estera negra ·
 plastica, cromo, bianco opaco o nero opaco · plastica, crom, alb mat sau negru mat · muovi, kromi, mattavalkoinen tai mattamusta ·
 plastik, chrom, biały mat lub czarny mat



06



31



32

Einbauleuchte · Recessed light

Ø 8,2 cm, ↑ 4 cm
 incl. 1 x SMD, 5 W
 450 lm, 3.000 K

652310106 | Chrom · chrome
 652310131 | Weiß matt · white mat
 652310132 | Schwarz matt · black mat



IP20

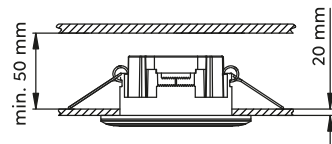

06



31



32

Einbauleuchte · Recessed light

Ø 14,8 cm, ↑ 3,8 cm
 incl. 1 x SMD, 10 W
 1.040 lm, 3.000 K

652410106 | Chrom · chrome
 652410131 | Weiß matt · white mat
 652410132 | Schwarz matt · black mat



IP20

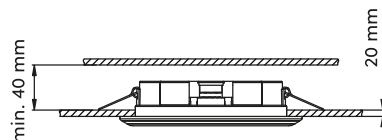

1x

2x

3x



Getrennt schaltbar · Separately switchable
 Interrupteurs séparés · Gescheiden schakelbaar ·
 Interruptores separados · Interruttori separati ·
 Intrerupatoare separate · Erikseen kytkettävissä ·
 Oddzielny przełącznik

CORE

Kunststoff, Chrom, Weiß matt oder Schwarz matt · plastic, chrome, white mat or black mat ·
 plastique, chrome, blanc mat ou noir mat · kunststof, chroom, wit mat of mat zwart · plástico, cromo, estera blanca o estera negra ·
 plastica, cromo, bianco opaco o nero opaco · plastic, crom, alb mat sau negru mat · muovi, kromi, mattavalkoinen tai mattamusta ·
 plastik, chrom, biały mat lub czarny mat



06



31



32

Einbauleuchte · Recessed light

Ø 8,2 cm, ↑ 3,5 cm
 incl. 1 x SMD, 5 W
 450 lm, 3.000 K

652510106 | Chrom · chrome
 652510131 | Weiß matt · white mat
 652510132 | Schwarz matt · black mat



IP20

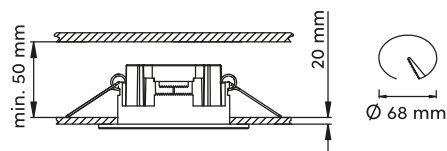

06



31



32

Einbauleuchte · Recessed light

Ø 14,8 cm, ↑ 3,3 cm
 incl. 1 x SMD, 10 W
 1.040 lm, 3.000 K

652610106 | Chrom · chrome
 652610131 | Weiß matt · white mat
 652610132 | Schwarz matt · black mat



IP20

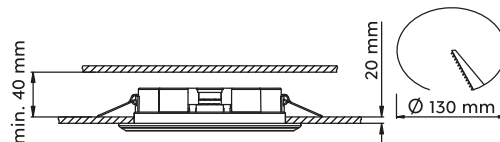

1x

2x

3x



Getrennt schaltbar · Separately switchable
 Interrupteurs séparés · Gescheiden schakelbaar ·
 Interruptores separados · Interruttori separati ·
 Intrerupatoare separate · Erikseen kytkettävissä ·
 Oddzileny przełącznik



NIMBUS

Kunststoff, Chrom, Weiß matt oder Schwarz matt · plastic, chrome, white mat or black mat ·
 plastique, chrome, blanc mat ou noir mat · kunststof, chroom, wit mat of mat zwart · plástico, cromo, estera blanca o estera negra ·
 plastica, cromo, bianco opaco o nero opaco · plastik, crom, alb mat sau negru mat · muovi, kromi, mattavalkoinen tai mattamusta ·
 plastik, chrom, biały mat lub czarny mat



06



31



32



Einbauleuchte · Recessed light

↔ 8,5 x 8,5 cm, ↓ 4 cm
 incl. 1 x SMD, 5 W
 450 lm, 3.000 K

653410106 | Chrom · chrome
 653410131 | Weiß matt · white mat
 653410132 | Schwarz matt · black mat

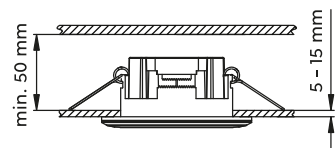

IP44

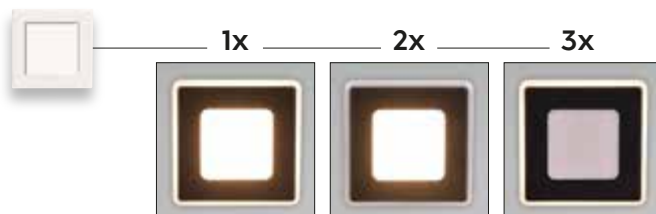

Getrennt schaltbar · Separately switchable
 Interrupteurs séparés · Gescheiden schakelbaar ·
 Interruptores separados · Interruttori separati ·
 Intrerupatoare separate · Erikseen kytkettävissä ·
 Oddzielny przełącznik

ARGUS

Kunststoff, Chrom, Weiß matt oder Schwarz matt · plastic, chrome, white mat or black mat ·
 plastique, chrome, blanc mat ou noir mat · kunststof, chrom, wit mat of mat zwart · plástico, cromo, estera blanca o estera negra ·
 plastica, cromo, bianco opaco o nero opaco · plastik, crom, alb mat sau negru mat · muovi, kromi, mattavalkoinen tai mattamusta ·
 plastik, chrom, biały mat lub czarny mat



06



31



32



Einbauleuchte · Recessed light

Ø 8,2 cm, ↓ 4 cm

incl. 1 x SMD, 4 W

350 lm, 3.000 K

incl. 1 x RGB-LED, 1 W

653610106 | Chrom · chrome

653610131 | Weiß matt · white mat

653610132 | Schwarz matt · black mat

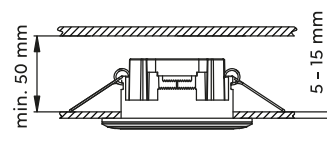

3er Set / Set 3

653610306 | Chrom · chrome

653610331 | Weiß matt · white mat

653610332 | Schwarz matt · black mat



Getrennt schaltbar · Separately switchable
 Interrupteurs séparés · Gescheiden schakelbaar ·
 Interruptores separados · Interruttori separati ·
 Intrerupatoare separate · Erikseen kytkettävissä ·
 Oddzileny przełącznik



ZAGROS

Metall · metal ·
metale · metaal · metal · metallo · metal · metalli · metal ·

 Dimmbar ·
Dimmable



06



07



31



32



Einbauleuchte · Recessed light
Ø 8,5 cm, ↓ 5,4 cm
incl. 1 x SMD, 5,5 W
345 lm, 3.000 K

- 650710106 | Chrom · chrome
- 650710107 | Nickel matt · nickel mat
- 650710131 | Weiß matt · white mat
- 650710132 | Schwarz matt · black mat

 IP65

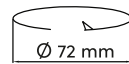
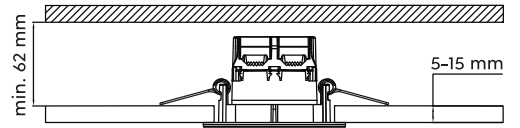

06



07



31



32



Einbauleuchte · Recessed light
↔ 8,5 x 8,5 cm, ↓ 5,4 cm
incl. 1 x SMD, 5,5 W
345 lm, 3.000 K

- 650610106 | Chrom · chrome
- 650610107 | Nickel matt · nickel mat
- 650610131 | Weiß matt · white mat
- 650610132 | Schwarz matt · black mat

 IP65

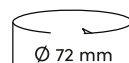
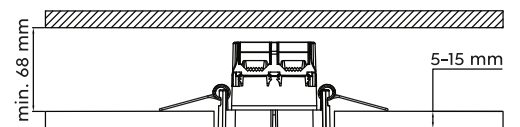

PAMIR

Metall · metal ·
metale · metaal · metal · metallo · metal · metalli · metal ·

 Dimmbar ·
Dimmable



06



07



31



32



Einbauleuchte · Recessed light

Ø 8,5 cm, ↓ 5,4 cm
incl. 1 x SMD, 5,5 W
345 lm, 3.000 K

650510106 | Chrom · chrome
650510107 | Nickel matt · nickel mat
650510131 | Weiß matt · white mat
650510132 | Schwarz matt · black mat

  IP23

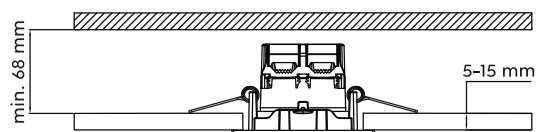

Ø 72 mm



06



07



31



32



Einbauleuchte · Recessed light

↔ 8,5 x 8,5 cm, ↓ 5,4 cm
incl. 1 x SMD, 5,5 W
345 lm, 3.000 K

650410106 | Chrom · chrome
650410107 | Nickel matt · nickel mat
650410131 | Weiß matt · white mat
650410132 | Schwarz matt · black mat

  IP23

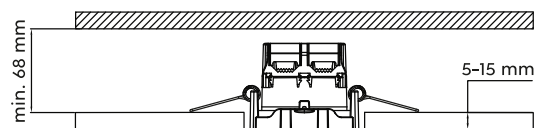

Ø 72 mm



Empfohlen:
recommended: LED GU10, 3 W
250 lm, 3.000 K



956-30

PIRIN

Kristallglas · crystal glass ·
verre cristal · kristal glas · vidrio cristal · vetro cristallo · sticla cristal · kristallilasi · szkło kryształ



Einbauleuchte · Recessed light

Ø 9 cm, ↓ 7 cm
excl. 1 x GU10, max. 10 W



652100152

Einbauleuchte · Recessed light

↔ 9 x 9 cm, ↓ 7 cm
excl. 1 x GU10, max. 10 W



652200152

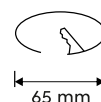
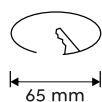
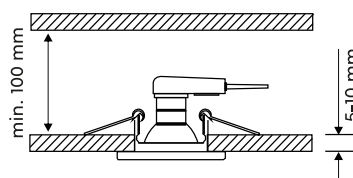
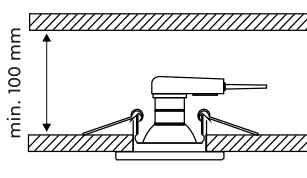

DOLOMITE

Kristallglas · crystal glass ·
verre cristal · kristal glas · vidrio cristal · vetro cristallo · sticla cristal · kristallilasi · szkło kryształ



Einbauleuchte · Recessed light

Ø 9 cm, ↓ 9,5 cm
excl. 1 x GU10, max. 10 W



651700152

Einbauleuchte · Recessed light

↔ 10 x 10 cm, ↓ 9,5 cm
excl. 1 x GU10, max. 10 W



651800152

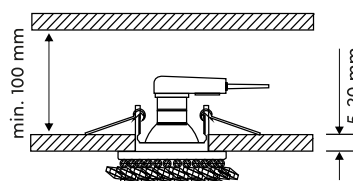
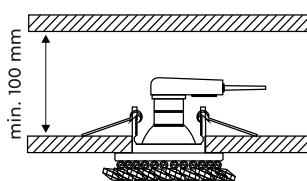



RILA

Metall · metal ·
metale · metaal · metal · metallo · metal · metalli · metal ·

 Schwenkbar ·
Tilttable



06



07



31

Einbauleuchte · Recessed light

Ø 8,2 cm, ↑ 3,4 cm
incl. 1 x SMD, 5 W
450 lm, 3.000 K

- 650310106 | Chrom · chrome
- 650310107 | Nickel matt · nickel mat
- 650310131 | Weiß matt · white mat

  IP20

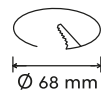
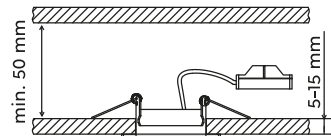

06



07



31

Einbauleuchte · Recessed light

↔ 8 x 8 cm, ↑ 3,4 cm
incl. 1 x SMD, 5 W
450 lm, 3.000 K

- 650210106 | Chrom · chrome
- 650210107 | Nickel matt · nickel mat
- 650210131 | Weiß matt · white mat

  IP20

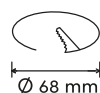
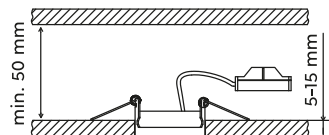

KENAI

Metall · metal ·
metale · metaal · metal · metallo · metal · metalli · metal

 Schwenkbar ·
Tilttable



31



32

Einbauleuchte · Recessed light
Ø 9,2 cm, ↓ 10 cm
excl. 1 x GU10, max. 15 W

651500131 | Weiß matt · white mat
651500132 | Schwarz matt · black mat

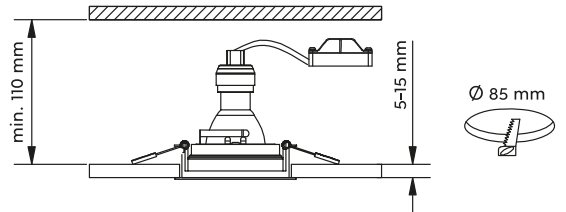

512



31



32

Einbauleuchte · Recessed light
↔ 9,2 x 9,2 cm, ↓ 10 cm
excl. 1 x GU10, max. 15 W

651600131 | Weiß matt · white mat
651600132 | Schwarz matt · black mat

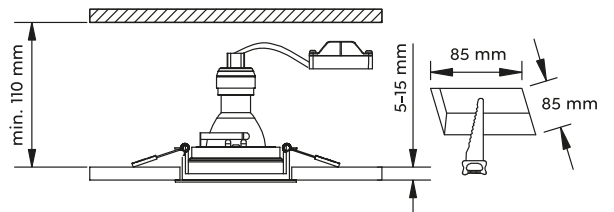

31



32

Einbauleuchte · Recessed light
↔ 17,2 x 9,2 cm, ↓ 10 cm
excl. 2 x GU10, max. 15 W

651600231 | Weiß matt · white mat
651600232 | Schwarz matt · black mat

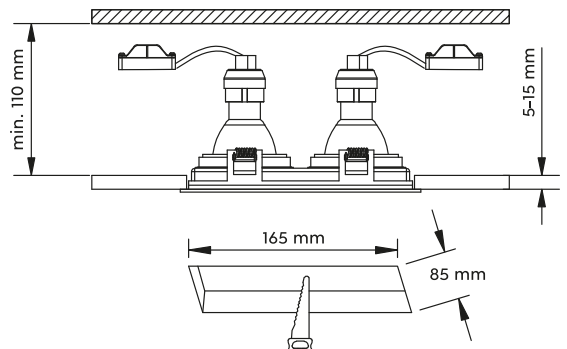

Empfohlen:
recommended: LED GU10, 4,5 W
345 lm, 3.000 K



956-55



JURA

Metall · metal ·
metale · metaal · metal · metallo · metal · metalli · metal ·

 Schwenkbar ·
Tilttable



06



07



08



31



32

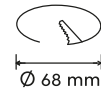
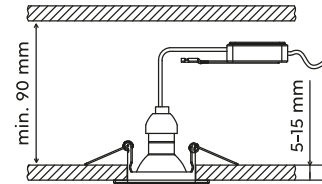

Einbauleuchte · Recessed light
Ø 8,3 cm, ↓ 7 cm
excl. 1 x GU10, max. 15 W

- 650100106 | Chrom · chrome
- 650100107 | Nickel matt · nickel mat
- 650100108 | Messing matt · brass mat
- 650100131 | Weiß matt · white mat
- 650100132 | Schwarz matt · black mat



514

Empfohlen:
recommended: LED GU10, 3 W
250 lm, 3.000 K



956-30



06



07



08



31



32

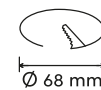
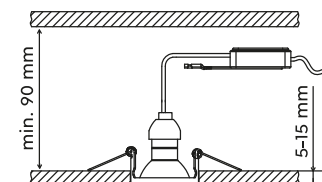

Einbauleuchte · Recessed light
↔ 8 x 8 cm, ↓ 7 cm
excl. 1 x GU10, max. 15 W

- 650000106 | Chrom · chrome
- 650000107 | Nickel matt · nickel mat
- 650000108 | Messing matt · brass mat
- 650000131 | Weiß matt · white mat
- 650000132 | Schwarz matt · black mat





07

3er Set / Set 3

650100306 | Chrom · chrome

650100307 | Nickel matt · nickel mat

650100331 | Weiß matt · white mat



31

3er Set / Set 3

650000306 | Chrom · chrome

650000307 | Nickel matt · nickel mat

650000331 | Weiß matt · white mat





Badezimmerleuchten

Bathroom lighting

Éclairage salle de bains

Badkamer verlichting

Iluminación de cuarto de baño

Illuminazione per bagno

Iluminat baie

Kylpyhuone valaistus

Oświetlenie łazienkowe



BOLSA

Chrom, Acryl · chrome, acryl ·
chrome, acryl · chroom, acryl · cromo, acrílico ·
cromo, acrílico · crom, acrílic · kromi, akryyli ·
chrom, akryl



Wandleuchte · Wall lamp
↓ 19 cm, ↔ 7 cm, ↗ 12 cm
incl. 1 x SMD-LED, 3,1 W
310 lm, 3.000 K



282410106



Wandleuchte · Wall lamp
↓ 30 cm, ↔ 7 cm, ↗ 12 cm
incl. 2 x SMD-LED, 3,1 W
2 x 310 lm, 3.000 K



282410206



Deckenleuchte · Ceiling lamp
Ø 41,5 cm, ↓ 16,5 cm
incl. 5 x SMD-LED, 3,1 W
5 x 310 lm, 3.000 K



682410506

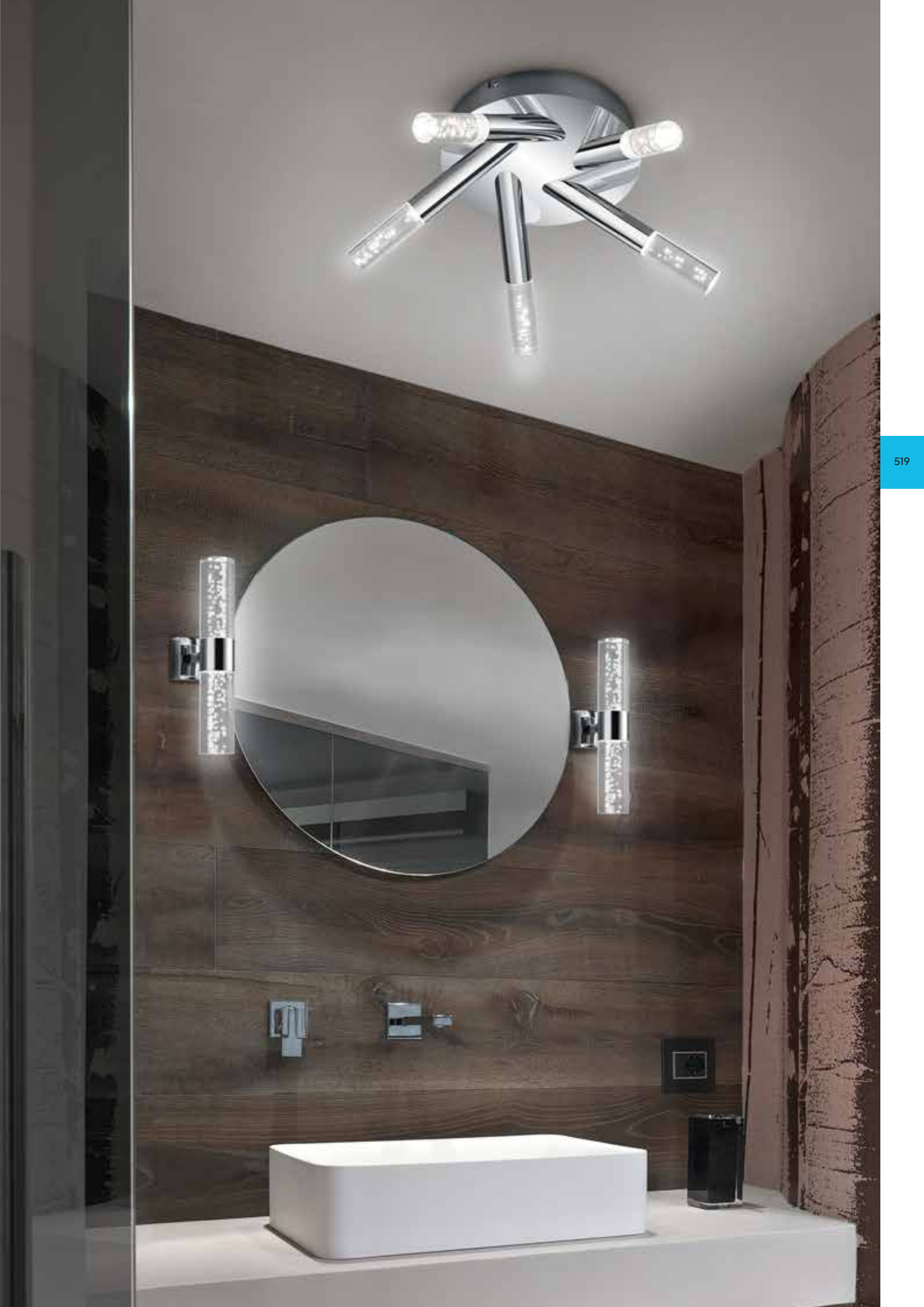



RAY

Kunststoff, Chrom oder Schwarz matt · plastic, chrome or black mat ·
 plastique, chrome ou noir mat · kunststof, chrom of mat zwart ·
 plástico, cromo o estera negra · plastica, cromo o nero opaco ·
 plastic, crom sau negru mat · muovi, kromi tai mattamusta ·
 plastik, chrom lub czarny mat

IP44

06 | Chrom · chrome

32 | Schwarz matt · black mat



Wandleuchte · Wall lamp

↓ 8,3 x 5,2 cm, ↗ 8 cm
 incl. 1 x SMD-LED, 4 W
 340 lm, 3.000 K



283110106
 283110132



Wandleuchte · Wall lamp

↓ 16,6 x 5,2 cm, ↗ 8 cm
 incl. 2 x SMD-LED, 4 W
 2 x 340 lm, 3.000 K



283110206
 283110232



KULA

Metall, Chrom oder Schwarz matt · metal, chrome or black mat ·
 metale, chrome ou noir mat · metaal, chrom of mat zwart ·
 metal, cromo o estera negra · metallo, cromo o nero opaco ·
 metal, crom sau negru mat · metalli, kromi tai mattamusta ·
 metal, chrom lub czarny mat

IP44



06 | Chrom · chrome



32 | Schwarz matt · black mat



H₂O

Wandleuchte · Wall lamp

↓ 20 cm, ↔ 14 cm, ↗ 17 cm
 excl. 1 x E14, max. 10 W



IP44



284270106

284270132



ROCCO

Metall, Chrom oder Schwarz matt · metal, chrome or black mat ·
 metale, chrome ou noir mat · metaal, chroom of mat zwart · metal, cromo o estera negra ·
 metallo, cromo o nero opaco · metal, crom sau negru mat · metalli, kromi tai mattamusta ·
 metal, chrom lub czarny mat



IP44



06 | Chrom · chrome



32 | Schwarz matt · black mat

Wandleuchte · Wall lamp

↔ 60 x 3,6 cm, ↗ 8 cm
 incl. SMD-LED, 8 W
 800 lm, 3.000 K



283916006
 283916032

Wandleuchte · Wall lamp

↔ 90 x 3,6 cm, ↗ 8 cm
 incl. SMD-LED, 13 W
 1.400 lm, 3.000 K



283919006
 283919032





FABIO



Metall, Chrom oder Schwarz matt · metal, chrome or black mat ·
 metallo, cromo o nero opaco · metal, crom sau negru mat · metalli, kromi tai mattamusta ·
 metal, chrom lub czarny mat

IP44



06 | Chrom · chrome

32 | Schwarz matt · black mat



Wandleuchte · Wall lamp
 ↔ 42,5 x 3,8 cm, ∅ 7,9 cm
 incl. SMD-LED, 6 W
 700 lm, 3.000 K



283814206
 283814232



Wandleuchte · Wall lamp
 ↔ 80 x 3,8 cm, ∅ 7,9 cm
 incl. SMD-LED, 12 W
 1.400 lm, 3.000 K



283817906
 283817932



Wandleuchte · Wall lamp
 ↔ 120 x 3,8 cm, ∅ 7,9 cm
 incl. SMD-LED, 20 W
 2.300 lm, 3.000 K



283811206
 283811232





Wandleuchte · Wall lamp
 ↔ 41,5 x 5,5 cm, ∇ 7 cm
 incl. SMD-LED, 8 W
 850 lm, 3.000 K



284074206
284074232



Wandleuchte · Wall lamp
 ↔ 79 x 5,5 cm, ∇ 7 cm
 incl. SMD-LED, 16 W
 1.650 lm, 3.000 K



284077906
284077932



Wandleuchte · Wall lamp
 ↔ 119 x 5,5 cm, ∇ 7 cm
 incl. SMD-LED, 21 W
 2.200 lm, 3.000 K



284071206
284071232



PIERA

Kunststoff, Chrom oder Schwarz matt · plastic, chrome or black mat ·
 plastique, chrome ou noir mat · kunststof, chrom of mat zwart · plástico, cromo o estera negra ·
 plastica, cromo o nero opaco · plastic, crom sau negru mat · muovi, kromi tai mattamusta ·
 plastik, chrom lub czarny mat



IP44



06 | Chrom · chrome



32 | Schwarz matt · black mat



Schuko-Steckdose · Schuco plug



Wandleuchte · Wall lamp
 ↔ 40,4 x 5,5 cm, ↗ 8,5 cm
 incl. 1 x SMD-LED, 4,3 W
 450 lm, 3.000 K



283270106
283270132



Wandleuchte · Wall lamp
 ↔ 60,4 x 5,5 cm, ↗ 8,8 cm
 incl. 1 x SMD-LED, 6,5 W
 680 lm, 3.000 K



283270206
283270232



Wandleuchte · Wall lamp
 ↔ 80,4 x 5,5 cm, ↗ 8,8 cm
 incl. 1 x SMD-LED, 8,6 W
 880 lm, 3.000 K



283270306
283270332



MATTIMO



Metall, Kunststoff, Chrom oder Schwarz matt · metal, plastic, chrome or black mat ·
 metale, plastique, chrome ou noir mat · metaal, kunststof, chroom of mat zwart · metal, plástico, cromo o estera negra ·
 metallo, plastica, cromo o nero opaco · metal, plastic, crom sau negru mat · metalli, muovi, kromi tai mattamusta ·
 metal, plastik, chrom lub czarny mat

IP44



06 | Chrom · chrome



32 | Schwarz matt · black mat





KOLIAN

Kunststoff, Chrom · plastic, chrome ·
 plastique, chrome · kunststof, chrom · plástico, cromo · plastica, cromo · plastic, crom · muovi, kromi · plastik, chrom



IP44



Steckdose ·
 Plug



Schuko-Steckdose ·
 Schuco plug



Wandleuchte · Wall lamp

↔ 44 x 6 cm, ∅ 9 cm
 incl. SMD-LED, 6 W
 700 lm, 3.000 K

IP44



281570606



Wandleuchte · Wall lamp

↔ 64 x 6 cm, ∅ 9 cm
 incl. SMD-LED, 9 W
 970 lm, 3.000 K

IP44



281570906





VIEW

Chrom · chrome ·
chrome · chroom · cromo · cromo ·
crom · kromi · chrom

IP44



On/Off Touch Funktion ·
On/Off Touch function



Vergrößerung 3x ·
Magnification 3x



Wandleuchte · Wall lamp
Ø 21 cm, ȳ max. 36 cm
incl. SMD-LED, 3 W
280 lm, 3.000 K



282990106



THEATRO

Chrom · chrome ·
chrome · chrom · cromo · cromo ·
crom · kromi · chrom

IP44



Empfohlen:
recommended: Filament LED E27, 4 W
420 lm, 2.800 K



987-410

H₂O

Wandleuchte · Wall lamp
↔ 55 x 8 cm, √ 6,5 cm
excl. 4 x E27, max. 28 W



283600406

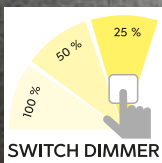

ASCARI

Metall, Chrom oder Schwarz matt · metal, chrome or black mat ·
 metale, chrome ou noir mat · metaal, chroom of mat zwart · metal, cromo o estera negra ·
 metallo, cromo o nero opaco · metal, crom sau negru mat · metalli, kromi tai mattamusta ·
 metal, chrom lub czarny mat

IP44



06 | Chrom · chrome



32 | Schwarz matt · black mat



Deckenleuchte · Ceiling lamp
 Ø 30 cm, ↓ 6,8 cm
 incl. SMD-LED, 28 W
 3.200 lm, 3.000 K



680810306
 680810332



Deckenleuchte · Ceiling lamp
 Ø 40 cm, ↓ 6,8 cm
 incl. SMD-LED, 35 W
 4.100 lm, 3.000 K



680819306
 680819332



GIANNI

Metall, Chrom oder Schwarz matt · metal, chrome or black mat ·
 metale, chrome ou noir mat · metaal, chrom of mat zwart · metal, cromo o estera negra ·
 metallo, cromo o nero opaco · metal, crom sau negru mat · metalli, kromi tai mattamusta ·
 metal, chrom lub czarny mat



IP44



Wandleuchte · Wall lamp
 ↔ 40 x 17,5 cm, ∠ 14,8 cm
 incl. SMD-LED, 17 W
 1.700 lm, 3.000 K



283770106
 283770132

Wandleuchte · Wall lamp
 ↔ 60 x 8 cm, ∠ 15 cm
 incl. SMD-LED, 22 W
 2.700 lm, 3.000 K



283779106
 283779132



06 | Chrom · chrome



32 | Schwarz matt · black mat



Strahler · Spot
 Ø 10,5 cm cm, ↗ 15,5 cm
 excl. 1 x GU10, max. 5 W



880400106
 880400132



Strahler · Spot
 Ø 20 cm, ↓ 15,5 cm
 excl. 3 x GU10, max. 5 W



880430306
 880430332



Strahler · Spot
 ↔ 52 x 9,5 cm, ↓ 19,5 cm
 excl. 4 x GU10, max. 5 W



880400406
 880400432



ANGELO

Metall, Chrom oder Schwarz matt · metal, chrome or black mat ·
 metale, chrome ou noir mat · metaal, chrom of mat zwart · metal, cromo o estera negra ·
 metallo, cromo o nero opaco · metal, crom sau negru mat · metalli, kromi tai mattamusta · metal, chrom lub czarny mat

IP44

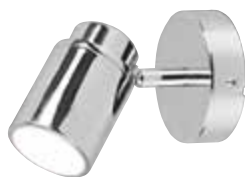

06 | Chrom · chrome

Empfohlen:
 recommended: LED GU10, 3 W
 250 lm, 3.000 K



956-30



32 | Schwarz matt · black mat





CAMILLA

Kunststoff, Schwarz matt · plastic, black mat ·
 plastique, noir mat · kunststof, mat zwart · plástico, estera negra ·
 plastica, nero opaco · plastic, negru mat · muovi, mattamusta · plastik, czarny mat

IP44

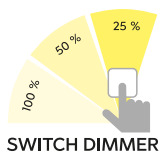

Deckenleuchte · Ceiling lamp
 Ø 40 cm, ↓ 3 cm
 incl. SMD-LED, 22 W
 2.700 lm, 3.000 K



689214032



Deckenleuchte · Ceiling lamp
 ↔ 40 x 40 cm, ↓ 3 cm
 incl. SMD-LED, 22 W
 2.700 lm, 3.000 K



689314032



CINZIA

Chrom, Acryl mit Kristalleffekt · chrome, broken glass optic ·
 chrome, optique verre pilé · chroom, Gebroken glas optiek ·
 cromo, Efecto cristal roto · cromo, effetto ottico vetro rotto ·
 crom, aspect de sticla sparta · kromi, lasi efekti optiikka ·
 chrom, Optyczne rozbite szkło

IP44

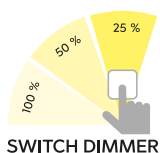

Deckenleuchte · Ceiling lamp
 Ø 40 cm, ↓ 3 cm
 incl. SMD-LED, 22 W
 2.700 lm, 3.000 K



686412406



Deckenleuchte · Ceiling lamp
 ↔ 40 x 40 cm, ↓ 3 cm
 incl. SMD-LED, 22 W
 2.700 lm, 3.000 K



686512406



APART

Kunststoff, Chrom · plastic, chrome ·
 plastique, chrome · kunststof, chroom · plástico, cromo ·
 plastica, cromo · plastic, crom · muovi, kromi · plastik, chrom

IP44



Deckenleuchte · Ceiling lamp
 Ø 35 cm, ↓ 10 cm,
 incl. SMD-LED, 18 W
 1.850 lm, 3.000 K



659411806



Deckenleuchte · Ceiling lamp
 Ø 41 cm, ↓ 10 cm,
 incl. SMD-LED, 22 W
 2.500 lm, 3.000 K



659412406

UMBERTO

Kunststoff, Chrom oder Schwarz matt · plastic, chrome or black mat ·
 plastique, chrome ou noir mat · kunststof, chrom of mat zwart · plástico, cromo o estera negra ·
 plastica, cromo o nero opaco · plastic, crom sau negru mat · muovi, kromi tai mattamusta ·
 plastik, chrom lub czarny mat



IP44



06 | Chrom · chrome



32 | Schwarz matt · black mat



Deckenleuchte · Ceiling lamp
 Ø 29 cm, ↓ 8 cm
 incl. SMD-LED, 12 W
 1.160 lm, 3.000 K



680310106
 680310132



Deckenleuchte · Ceiling lamp
 Ø 42 cm, ↓ 10 cm
 incl. SMD-LED, 18,5 W
 1.900 lm, 3.000 K



680319106
 680319132

PAOLO

Kunststoff, Weiß · plastic, white ·
 plastique, blanc · kunststof, wit · plástico, blanco ·
 plastica, bianco · plastic, alb · muovi, valkoinen · plastik, biały

IP44



Deckenleuchte · Ceiling lamp
 Ø 37 cm, ↑ 8,5 cm
 incl. SMD-LED, 15 W
 1.500 lm, 3.000 K



686014001



Deckenleuchte · Ceiling lamp
 Ø 37 cm, ↑ 8,5 cm
 incl. SMD-LED, 15 W
 1.500 lm, 4.000 K



686014000



FRODENO

Acryl · acryl ·
acryl · acryl · acrílico · acrílico · acrilic · akryyli · akryl

IP44



RGBW Farbwechsler ·
RGBW Colorchanging



Memory Funktion ·
Memory function



Starlight Effekt ·
Starlight effect



Deckenleuchte · Ceiling lamp
Ø 35 cm, ↑ 8,7 cm
incl. RGBW-LED, 12 W
1.200 lm, 4.000 K



680213500



Deckenleuchte · Ceiling lamp
Ø 48 cm, ↑ 10,2 cm
incl. RGBW-LED, 18,5 W
1.900 lm, 4.000 K



680214800



XAVI

Chrom, Glas matt · chrome, mat glass ·
 chrome, verre mat · chrom, mat glas · cromo, vidrio mate ·
 cromo, vetro sabbato · crom, sticla mata · kromi, mattalasi ·
 chrom, szkło matowane

IP21



Empfohlen:
 recommended: LED E14, 4,5 W
 470 lm, 2.700 K



989-400

Wandleuchte · Wall lamp
 ↔ 30,5 cm, ↑ 8,3 cm, ↗ 6,3 cm
 excl. 2 x E14, max. 40 W



2803021-06

Wandleuchte · Wall lamp
 ↔ 40,5 cm, ↑ 8,3 cm, ↗ 6,3 cm
 excl. 3 x E14, max. 40 W



2803031-06



CONDUS

Metall, Glas matt · metal, mat glass ·
 metale, verre mat · metaal, mat glas ·
 metal, vidrio mate · metallo, vetro sabbato ·
 metal, sticla mata · metalli, mattalasi ·
 metal, szkło matowane

IP44

Empfohlen:
 recommended: LED E27, 4 W
 470 lm, 2.700 K



987-400



01 | Weiß · white



06 | Chrom · chrome



07 | Nickel matt · nickel mat



32 | Schwarz matt · black matt



Deckenleuchte · Ceiling lamp

Ø 31,5 cm, ↑ 8 cm
 excl. 1 x E27, max. 60 W



6801011-01
 6801011-06
 6801011-07
 6801011-32

ZENIA

Metall · metal ·
metale · metaal · metal · metallo · metal · metalli · metal

IP65

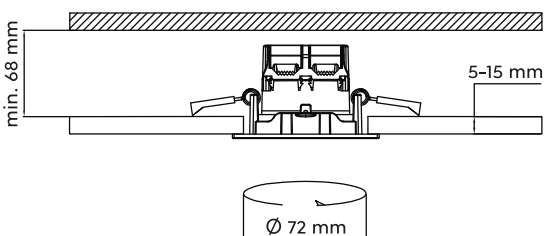

06 | Chrom · chrome



31 | Weiß matt · white mat



32 | Schwarz matt · black mat

Einbauleuchte · Recessed spot
Ø 8,5 cm, ↓ 5,4 cm
incl. SMD-LED, 5,5 W
345 lm, 3.000 K



680710106
680710131
680710132

CLARIMO

Kunststoff · plastic ·
plastique · kunststof · plástico · plastica · plastic · muovi · plastik



IP44

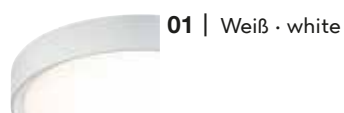

01 | Weiß · white

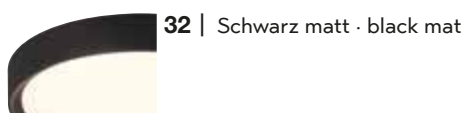

32 | Schwarz matt · black mat



06 | Chrom · chrome

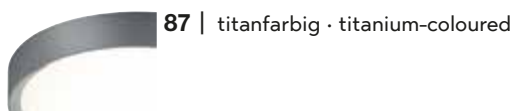

87 | titanfarbig · titanium-coloured

Deckenleuchte · Ceiling lamp
Ø 33 cm, 1 9 cm,
incl. SMD-LED, 18 W
1.850 lm, 3.000 K



659011801
659011806
659011832
659011887



LINO



Kunststoff, Chrom oder Schwarz matt · plastic, chrome or black mat ·
 plastique, chrome ou noir mat · kunststof, chrom of mat zwart · plástico, cromo o estera negra ·
 plastica, cromo o nero opaco · plastic, crom sau negru mat · muovi, kromi tai mattamusta ·
 plastik, chrom lub czarny mat

IP44



06 | Chrom · chrome



32 | Schwarz matt · black mat



Wandleuchte · Wall lamp
 ↔ 40 x 6 cm, ↗ 10,5 cm
 incl. SMD-LED, 7,4 W
 900 lm, 3.000 K



284114006
 284114032



Wandleuchte · Wall lamp
 ↔ 60 x 6 cm, ↗ 10,5 cm
 incl. SMD-LED, 11 W
 1.350 lm, 3.000 K



284116006
 284116032





LORENZO

Metall, Chrom oder Schwarz matt · metal, chrome or black mat ·
 metale, chrome ou noir mat · metaal, chrom of mat zwart · metal, cromo o estera negra ·
 metallo, cromo o nero opaco · metal, crom sau negru mat · metalli, kromi tai mattamusta ·
 metal, chrom lub czarny mat

IP44

Empfohlen:
 recommended: LED GU10, 3 W
 250 lm, 3.000 K



956-30



06 | Chrom · chrome



32 | Schwarz matt · black mat

Strahler · Spot
 ↓ 5,4 x 3,3 cm, ↗ 10,1 cm
 excl. 1 x GU10, max. 5 W



283500106
 283500132



GIADA



Metall, Chrom oder Schwarz matt · metal, chrome or black mat ·
 metale, chrome ou noir mat · metaal, chroom of mat zwart · metal, cromo o estera negra ·
 metallo, cromo o nero opaco · metal, crom sau negru mat · metalli, kromi tai mattamusta ·
 metal, chrom lub czarny mat

IP44

Empfohlen:
 recommended: LED GU10, 3 W
 250 lm, 3.000 K



956-30



06 | Chrom · chrome



32 | Schwarz matt · black mat

Strahler · Spot

↑ 11,4 x 5,4 cm, ↗ 34,3 cm
 excl. 1 x GU10, max. 5 W



IP44



283400106

283400132





Leuchtmittel

Light sources

Ampoules

Lichtbronnen

Fuentes de luz

Lampadine

Becuri

Valonlähdeet

Źródła światła

LED-LEUCHTMITTEL E27

LED bulbs E27 · Ampoules LED E27 · LED-lampen E27 · Bombillas a LED E27 ·
Lampadine a LED E27 · Becuri cu LED-uri E27 · LED-Valonläheteet E27 · Żarówki LED E27

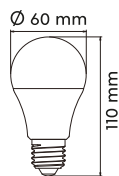

Code	Socket	Power	Lumen	Kelvin	Lifetime	Dimmable	Switch Dimmer	Switch Dim To Warm
987-60	E27	4,9 W	470 lm	3.000 K	25.000 h			
988-700	E27	6,5 W	560 lm	3.000 K	25.000 h	✓		
988-10	E27	8,5 W	806 lm	3.000 K	25.000 h		✓	
988-110	E27	10 W	806 lm	3.000 K	25.000 h	✓		

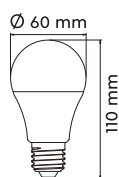

987-909	E27	9 W	806 lm	2.200 K 2.700 K 3.000 K	25.000 h			✓
---------	-----	-----	--------	-------------------------------	----------	--	--	---

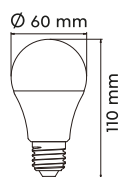

Set 2								
987-260	E27	4,9 W	470 lm	3.000 K	25.000 h			

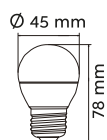

986-40	E27	3,5 W	470 lm	3.000 K	25.000 h			
986-60	E27	4,9 W	470 lm	3.000 K	25.000 h			

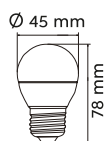

Set 3								
986-43	E27	3,5 W	320 lm	3.000 K	10.000 h			
986-63	E27	5 W	400 lm	3.000 K	10.000 h			

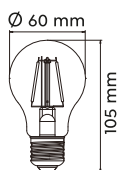

987-400	E27	4 W	470 lm	2.700 K	10.000 h			
987-6810	E27	7 W	806 lm	2.700 K	10.000 h		✓	

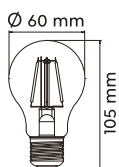

987-7009	E27	7 W	806 lm	2.200 K 2.700 K 3.000 K	10.000 h			✓
----------	-----	-----	--------	-------------------------------	----------	--	--	---

Code	Socket	Power	Lumen	Kelvin	Lifetime	Dimmable	Switch Dimmer	Switch Dim To Warm
------	--------	-------	-------	--------	----------	----------	---------------	--------------------

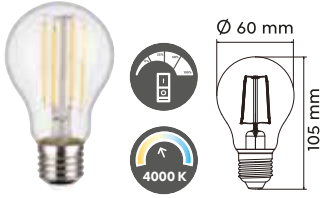

987-740	E27	7 W	806 lm	4.000 K	25.000 h		✓	
---------	-----	-----	--------	---------	----------	--	---	--

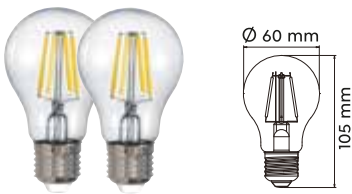

Set 2

987-2400	E27	4 W	470 lm	2.700 K	10.000 h			
----------	-----	-----	--------	---------	----------	--	--	--

555

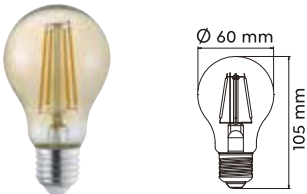

987-479 amber	E27	4 W	470 lm	2.700 K	10.000 h			
987-6700 amber	E27	7 W	700 lm	2.700 K	10.000 h		✓	

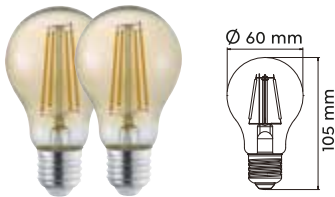

Set 2

987-2479 amber	E27	4 W	470 lm	2.700 K	10.000 h			
----------------	-----	-----	--------	---------	----------	--	--	--

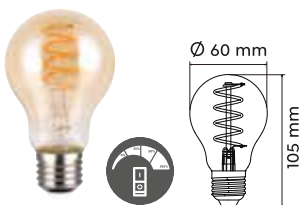

Deko-Filament

986-4813 amber	E27	7 W	400 lm	1.800 K	25.000 h		✓	
----------------	-----	-----	--------	---------	----------	--	---	--

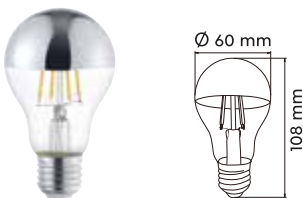

987-410 amber	E27	4 W	430 lm	2.800 K	10.000 h			
---------------	-----	-----	--------	---------	----------	--	--	--

LED-LEUCHTMITTEL E27

LED bulbs E27 · Ampoules LED E27 · LED-lampen E27 · Bombillas a LED E27 ·
Lampadine a LED E27 · Becuri cu LED-uri E27 · LED-Valonlähdeet E27 · Żarówki LED E27

Code	Socket	Power	Lumen	Kelvin	Lifetime	Dimmable	Switch Dimmer	Switch Dim To Warm
------	--------	-------	-------	--------	----------	----------	---------------	--------------------

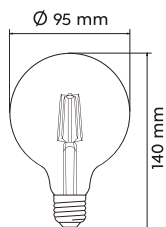

988-901	E27	9 W	1.055 lm	3.000 K	25.000 h			
---------	-----	-----	----------	---------	----------	--	--	--

556

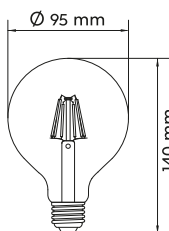

988-600	E27	7 W	806 lm	3.000 K	10.000 h			
985-6810	E27	7 W	806 lm	2.700 K	10.000 h		✓	

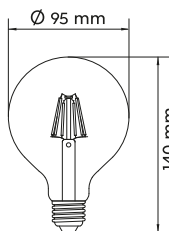

988-679 amber	E27	6 W	660 lm	2.700 K	10.000 h			
---------------	-----	-----	--------	---------	----------	--	--	--

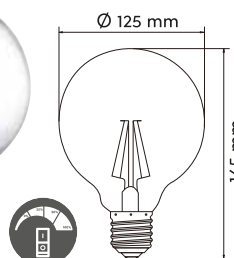

986-6810 clear	E27	7 W	806 lm	2.700 K	10.000 h		✓	
----------------	-----	-----	--------	---------	----------	--	---	--

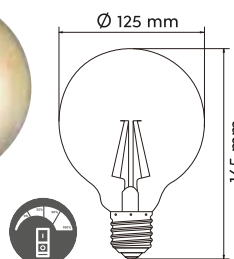

986-6790 amber	E27	8 W	806 lm	2.700 K	10.000 h		✓	
----------------	-----	-----	--------	---------	----------	--	---	--

Code	Socket	Power	Lumen	Kelvin	Lifetime	Dimmable	Switch Dimmer	Switch Dim To Warm
------	--------	-------	-------	--------	----------	----------	---------------	--------------------

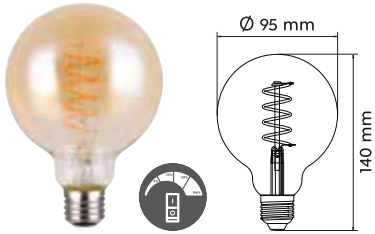

Deko-Filament

988-4813	E27	7 W	400 lm	1.800 K	25.000 h		✓	
----------	-----	-----	--------	---------	----------	--	---	--

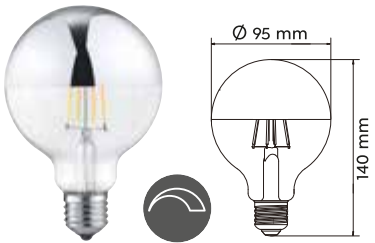

988-710	E27	7 W	680 lm	2.700 K	10.000 h	✓		
---------	-----	-----	--------	---------	----------	---	--	--



986-710	E27	7 W	680 lm	2.700 K	10.000 h	✓		
---------	-----	-----	--------	---------	----------	---	--	--



987-600	clear	E27	7 W	806 lm	3.000 K	10.000 h		
987-679	amber	E27	6 W	600 lm	2.700 K	10.000 h		

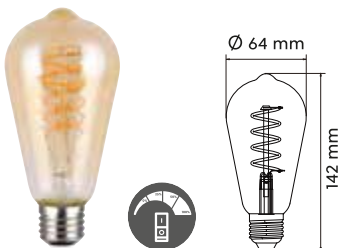

Deko-Filament

987-4813	E27	7 W	500 lm	1.800 K	25.000 h		✓	
----------	-----	-----	--------	---------	----------	--	---	--

LED-LEUCHTMITTEL E27

LED bulbs E27 · Ampoules LED E27 · LED-lampen E27 · Bombillas a LED E27 ·
Lampadine a LED E27 · Becuri cu LED-uri E27 · LED-Valonl hteet E27 ·  ar wki LED E27

Code	Socket	Power	Lumen	Kelvin	Lifetime	Dimmable	Switch Dimmer	Switch Dim To Warm
------	--------	-------	-------	--------	----------	----------	---------------	--------------------

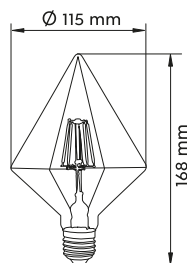

901-479	amber	E27	4 W	360 lm	2.700 K	25.000 h		
---------	-------	-----	-----	--------	---------	----------	--	--

558

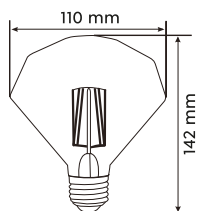

902-479	amber	E27	4 W	360 lm	2.700 K	25.000 h		
---------	-------	-----	-----	--------	---------	----------	--	--

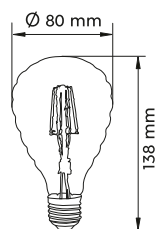

903-479	amber	E27	4 W	360 lm	2.700 K	25.000 h		
---------	-------	-----	-----	--------	---------	----------	--	--

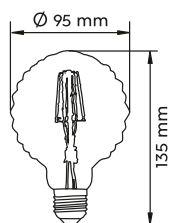

904-479	amber	E27	4 W	360 lm	2.700 K	25.000 h		
---------	-------	-----	-----	--------	---------	----------	--	--

LED-LEUCHTMITTEL E14

LED bulbs E14 · Ampoules LED E14 · LED-lampen E14 · Bombillas a LED E14 · Lampadine a LED E14 · Becuri cu LED-uri E14 · LED-Valonlähdeet E14 · Żarówki LED E14

Code	Socket	Power	Lumen	Kelvin	Lifetime	Dimmable	Switch Dimmer	Switch Dim To Warm
------	--------	-------	-------	--------	----------	----------	---------------	--------------------

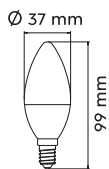

989-40	E14	3,5 W	320 lm	3.000 K	25.000 h			
989-56	E14	4,9 W	400 lm	3.000 K	25.000 h	✓		
989-60	E14	4,9 W	470 lm	3.000 K	25.000 h			
989-66	E14	4,9 W	470 lm	3.000 K	25.000 h		✓	

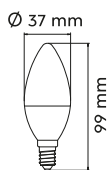

989-509	E14	4,9 W	470 lm	2.200 K	25.000 h			✓
				2.700 K				
				3.000 K				

559

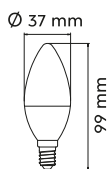

Set 3

989-43	E14	4 W	320 lm	3.000 K	25.000 h			
989-63	E14	6 W	470 lm	3.000 K	25.000 h			

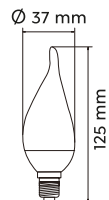

990-40	E14	3,5 W	320 lm	3.000 K	25.000 h			
--------	-----	-------	--------	---------	----------	--	--	--

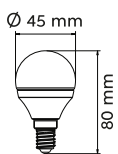

983-40	E14	3,5 W	320 lm	3.000 K	25.000 h			
983-56	E14	4,9 W	470 lm	3.000 K	25.000 h	✓		
983-60	E14	4,9 W	470 lm	3.000 K	25.000 h			
983-66	E14	4,9 W	470 lm	3.000 K	25.000 h		✓	

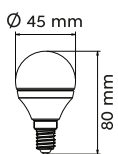

983-509	E14	5,5 W	400 lm	2.200 K	25.000 h			✓
				2.700 K				
				3.000 K				

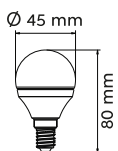

Set 3

983-43	E14	3,5 W	320 lm	3.000 K	25.000 h			
983-63	E14	4,9 W	470 lm	3.000 K	25.000 h			

LED-LEUCHTMITTEL E14

LED bulbs E14 · Ampoules LED E14 · LED-lampen E14 · Bombillas a LED E14 ·
Lampadine a LED E14 · Becuri cu LED-uri E14 · LED-Valonlähdeet E14 · Żarówki LED E14

Code	Socket	Power	Lumen	Kelvin	Lifetime	Dimmable	Switch Dimmer	Switch Dim To Warm
------	--------	-------	-------	--------	----------	----------	---------------	--------------------

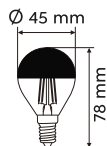

983-410	E14	4 W	420 lm	3.000 K	10.000 h			
---------	-----	-----	--------	---------	----------	--	--	--

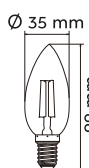

989-200	clear	E14	2 W	250 lm	2.700 K	10.000 h		
989-279	amber	E14	2 W	225 lm	2.700 K	10.000 h		
989-400	clear	E14	4 W	470 lm	2.700 K	10.000 h		
989-479	amber	E14	4 W	400 lm	2.700 K	10.000 h		

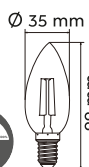

989-4470	clear	E14	4 W	470 lm	2.700 K	10.000 h		✓
989-4790	amber	E14	4 W	400 lm	2.700 K	10.000 h		✓

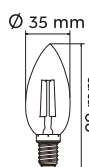

Set 3

989-3200	clear	E14	2 W	250 lm	2.700 K	10.000 h		
989-3279	amber	E14	2 W	225 lm	2.700 K	10.000 h		
989-3400	clear	E14	4,5 W	470 lm	2.700 K	10.000 h		

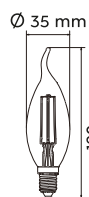

990-200	clear	E14	2 W	250 lm	2.700 K	10.000 h		
990-279	amber	E14	2 W	225 lm	2.700 K	10.000 h		
990-400	clear	E14	4 W	470 lm	3.000 K	10.000 h		



990-4470	clear	E14	4 W	470 lm	2.700 K	10.000 h		✓
990-4790	amber	E14	4 W	400 lm	2.700 K	10.000 h		✓

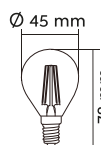

983-200	clear	E14	2 W	250 lm	2.700 K	10.000 h		
983-279	amber	E14	2 W	225 lm	2.700 K	10.000 h		
983-400	clear	E14	4 W	470 lm	2.700 K	10.000 h		
983-479	amber	E14	4 W	430 lm	2.700 K	10.000 h		

Code	Socket	Power	Lumen	Kelvin	Lifetime	Dimmable	Switch Dimmer	Switch Dim To Warm
------	--------	-------	-------	--------	----------	----------	---------------	--------------------



983-4470	clear	E14	4,5 W	470 lm	2.700 K	10.000 h		✓
983-4790	amber	E14	4 W	400 lm	2.700 K	10.000 h		✓

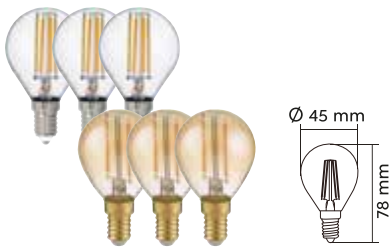

983-3200	clear	E14	2 W	250 lm	2.700 K	10.000 h		
983-3279	amber	E14	2 W	225 lm	2.700 K	10.000 h		
983-3400	clear	E14	4,5 W	470 lm	2.700 K	10.000 h		



983-440		E14	4 W	500 lm	4.000 K	25.000 h		
---------	--	-----	-----	--------	---------	----------	--	--

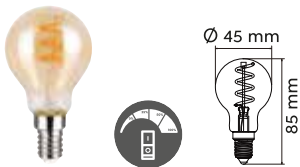

Deko-Filament		Socket	Power	Lumen	Kelvin	Lifetime	Dimmable	Switch Dimmer	Switch Dim To Warm
983-4813		E14	4 W	180 lm	1.800 K	25.000 h			

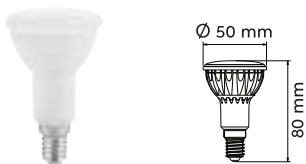

955-55	★ 110°	E14	5 W	400 lm	3.000 K	25.000 h		
--------	--------	-----	-----	--------	---------	----------	--	--

LED-LEUCHTMITTEL G9

LED bulbs G9 · Ampoules LED G9 · LED-lampen G9 · Bombillas a LED G9 ·
Lampadine a LED G9 · Becuri cu LED-uri G9 · LED-Valonlähteet G9 · Żarówki LED G9



Code	Socket	Power	Lumen	Kelvin	Lifetime	Dimmable	Switch Dimmer	Switch Dim To Warm
Set 2								
929-220	G9	2,3 W	200 lm	3.000 K	25.000 h			

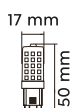

Set 2								
929-2300	G9	3 W	300 lm	3.000 K	25.000 h	✓		



Set 2								
929-230	G9	3 W	300 lm	3.000 K	25.000 h		✓	

LED-LEUCHTMITTEL GU10

LED bulbs GU10 · Ampoules LED GU10 · LED-lampen GU10 · Bombillas a LED GU10 ·
Lampadine a LED GU10 · Becuri cu LED-uri GU10 · LED-Valonlähteet GU10 · Żarówki LED GU10

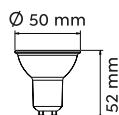

Code	Socket	Power	Lumen	Kelvin	Lifetime	Dimmable	Switch Dimmer	Switch Dim To Warm
956-30	GU10	3 W	230 lm	3.000 K	20.000 h			

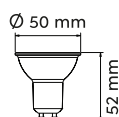

Set 3								
956-330	GU10	3 W	230 lm	3.000 K	15.000 h			

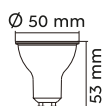

956-44	GU10	4,5 W	400 lm	4.000 K	25.000 h		✓	
--------	------	-------	--------	---------	----------	--	---	--

Code	Socket	Power	Lumen	Kelvin	Lifetime	Dimmable	Switch Dimmer	Switch Dim To Warm
------	--------	-------	-------	--------	----------	----------	---------------	--------------------

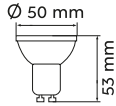

955-50	⚡ 110°	GU10	4,9 W	430 lm	3.000 K	25.000 h		
--------	--------	------	-------	--------	---------	----------	--	--

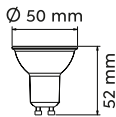

956-5936	⚡ 36°	GU10	4,5 W	345 lm	3.000 K	20.000 h	✓	
----------	-------	------	-------	--------	---------	----------	---	--

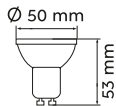

956-5736	⚡ 36°	GU10	4,5 W	345 lm	3.000 K	20.000 h		✓
----------	-------	------	-------	--------	---------	----------	--	---

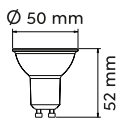

956-55	⚡ 110°	GU10	4,5 W	345 lm	3.000 K	25.000 h		✓
--------	--------	------	-------	--------	---------	----------	--	---

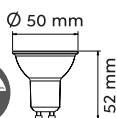

Set 3

956-355	⚡ 110°	GU10	4,5 W	345 lm	3.000 K	25.000 h		✓
---------	--------	------	-------	--------	---------	----------	--	---

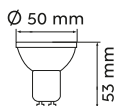

956-509	⚡ 36°	GU10	4,5 W	345 lm	2.200 K	25.000 h			✓
					2.700 K				
					3.000 K				



Stufenlos dimmbar mit herkömmlichem Lichtregler.
Continuously dimmable with conventional light controller.



Switch Dim to Warm
Helligkeit und Lichtfarbe in 3 Stufen mit herkömmlichem Lichtschalter einstellbar.
Brightness and light colour adjustable in 3 levels with conventional light switch.

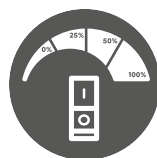

Switch Dimmer
Helligkeit in 3 Stufen mit herkömmlichem Lichtschalter einstellbar.
Brightness adjustable in 3 levels with conventional light switch.

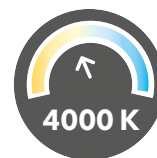

Die Lichtfarbe dieser Leuchte beträgt 4.000 Kelvin (K). Die Wirkung wird als neutralweiß beschrieben.
The light color of this lamp is 4,000 Kelvin (K). The effect is described as neutral white.

POS-LÖSUNGEN

POS solutions · Solutions de POS · POS-oplossingen ·
Soluciones POS · Soluzioni POS · Soluții POS · POS-ratkaisut · Rozwiązania POS

LME 100-240

Tego-Regale · Tego shelves
Leuchtmittel · light sources

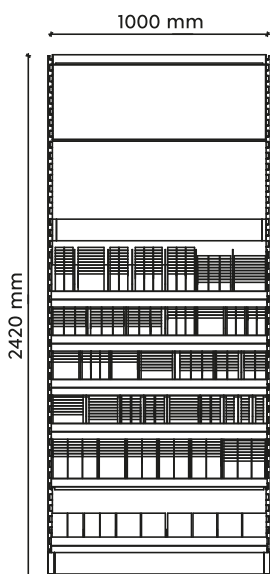
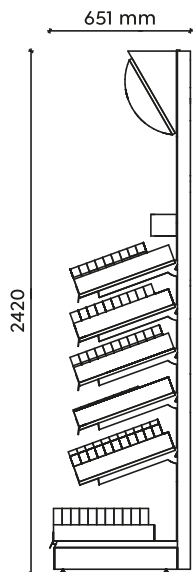



Display **RK 51-B**
Leuchtmittel · light sources

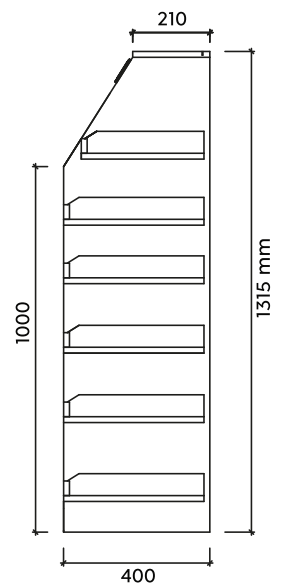
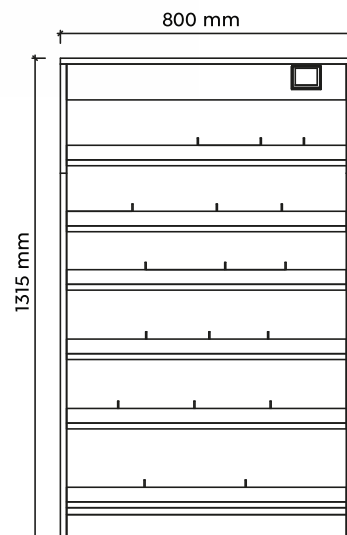

POS-LÖSUNGEN

POS solutions · Solutions de POS · POS-oplossingen · Soluciones POS · Soluzioni POS · Soluții POS · POS-ratkaisut · Rozwiązania POS



Display **RK 58**
Deckenleuchten · Ceiling lamps

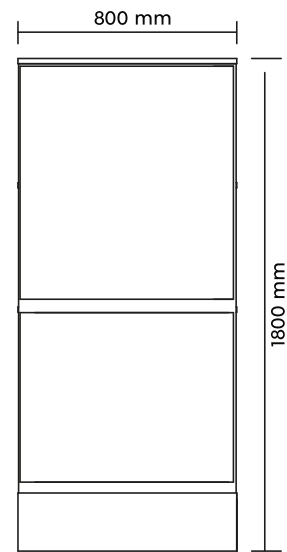
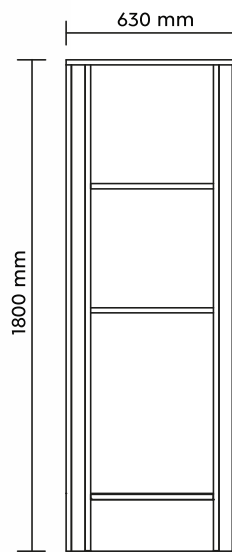

566

Display **RK 75**
Deckenleuchten · Ceiling lamps

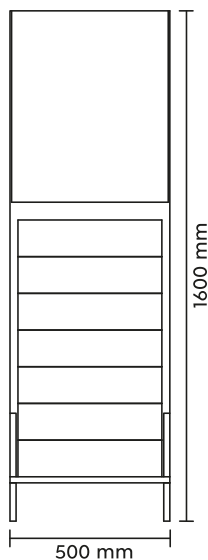
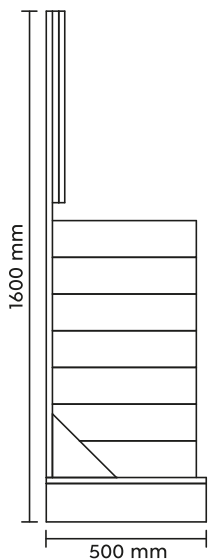



Display **RK 106**
Spots - Spots

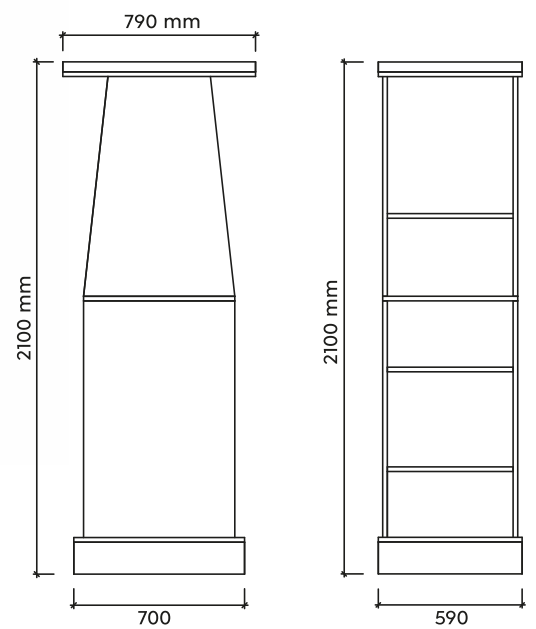

POS-LÖSUNGEN

POS solutions · Solutions de POS · POS-oplossingen ·
Soluciones POS · Soluzioni POS · Soluții POS · POS-ratkaisut · Rozwiązania POS

Tego-Regale · Tego shelves
Schienensystem · track system

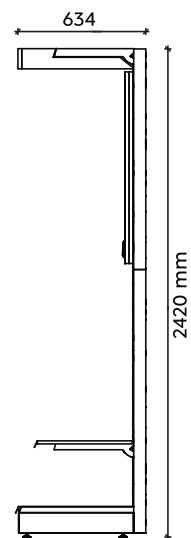
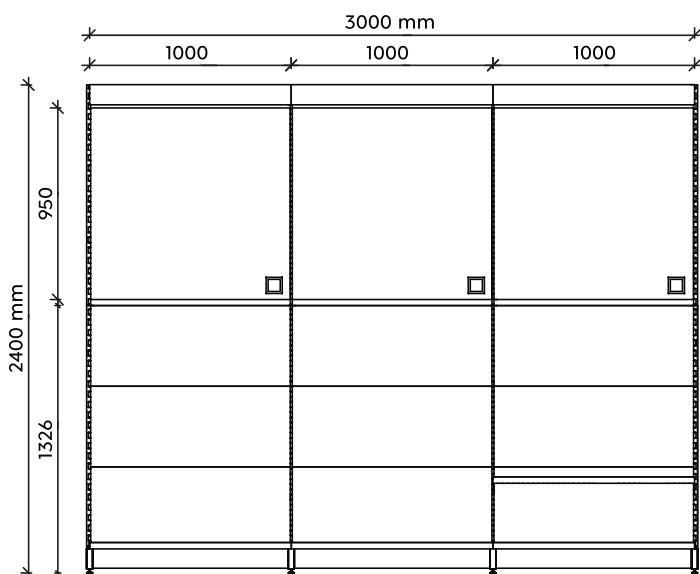

Display **DUO 01**
Schienensystem · track system



569

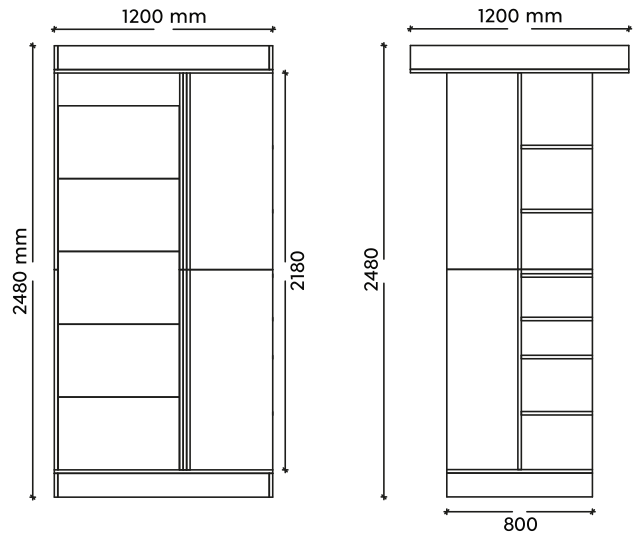

POS-LÖSUNGEN

POS solutions · Solutions de POS · POS-oplossingen ·
Soluciones POS · Soluzioni POS · Soluții POS · POS-ratkaisut · Rozwiązania POS

Tego-Regale · Tego shelves
Einbauleuchten · recessed lights

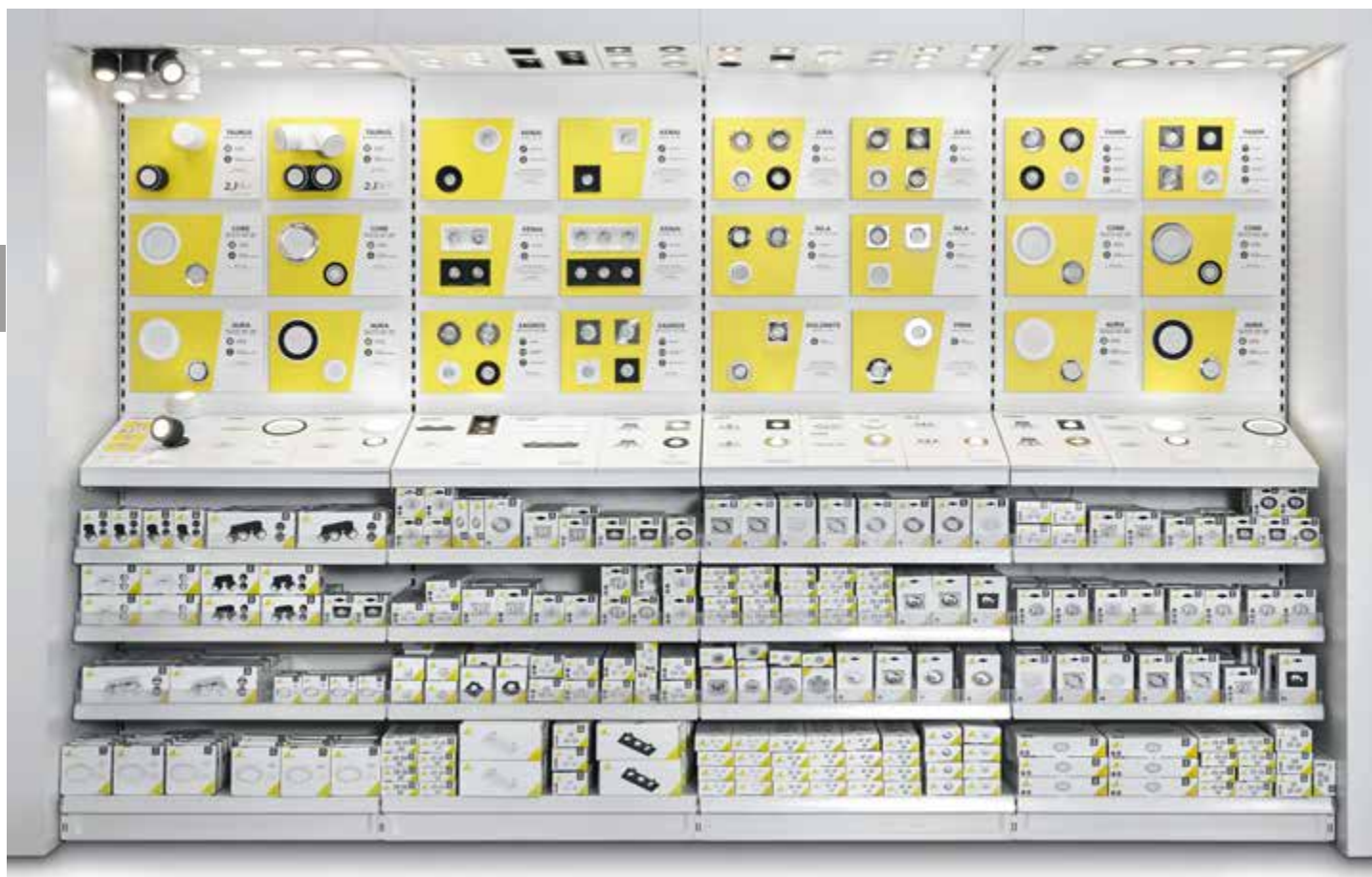

570

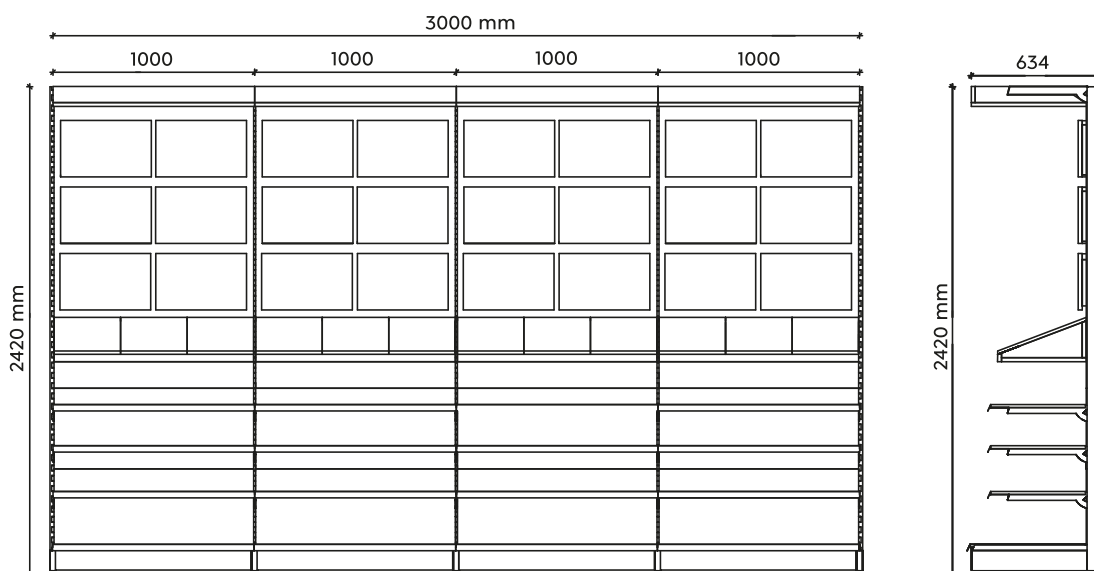

Display **RK 63**
Einbauleuchten · recessed lights

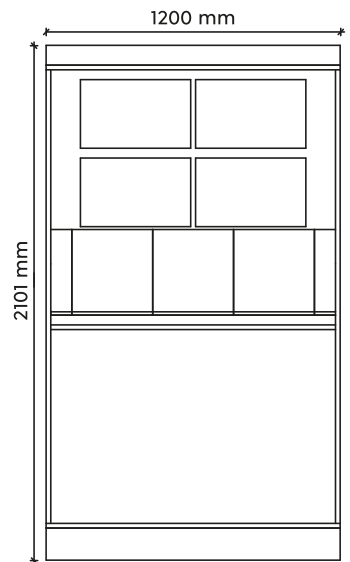
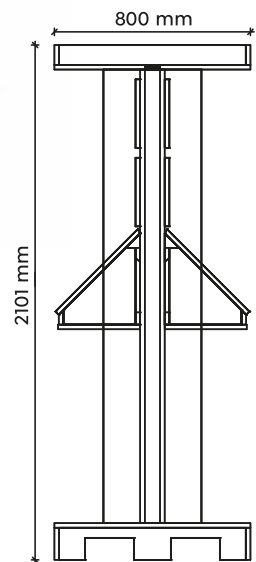

POS-LÖSUNGEN

POS solutions · Solutions de POS · POS-oplossingen ·
Soluciones POS · Soluzioni POS · Soluții POS · POS-ratkaisut · Rozwiązania POS

Tego-Regale · Tego shelves
Badezimmerleuchten · bathroom lighting

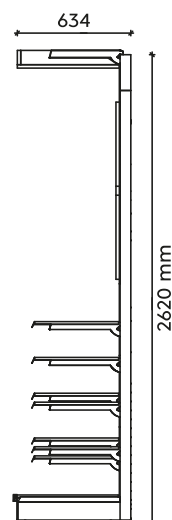
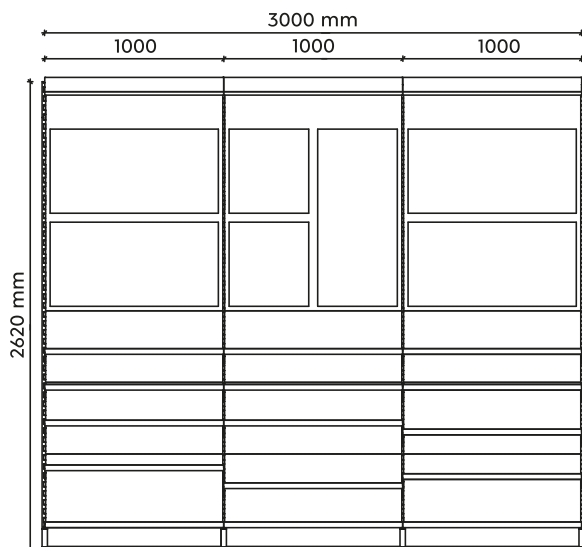

Display **RK 99**
Badezimmerleuchten · bathroom lighting

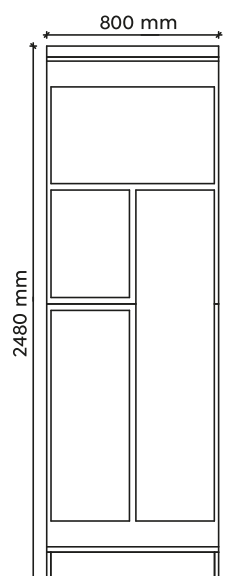
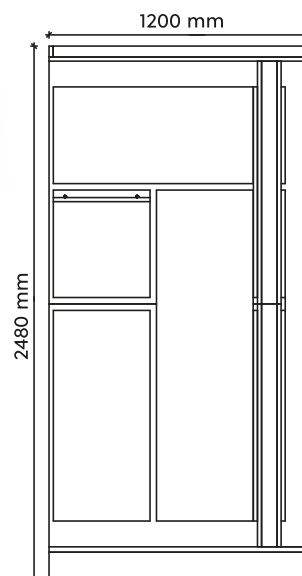



Spezifikationen

Specifications

Spécifications

Specificaties

Especificaciones

Specifiche

Specificații

Tekniset tiedot

Specyfikacje

FARBEN & MATERIALIEN

Colours and materials · Couleurs et matériaux · Kleuren en materialen · Colores y materiales ·
Colori e materiali · Colori si materiale · Värit ja materiaalit · Kolory i materiały · Renkler ve malzemeler

- 00** Transparent · transparent
transparent · transparant · transparente · transparente ·
transparent · kirkas · przezroczysty · şeffaf
- 01** Weiß · white
blanc · wit · blanco · bianco · alb · valkoinen · biały · beyaz
- 02** Schwarz · black
noir · zwart · negro · nero · negru · musta · czarny · siyah
- 03** Messing poliert · polished brass
laiton polis · gepolijst messing · bronce · ottone lucido ·
bronz · messinki · mosiądz polerowany · piring
- 04** Altmessing · old brass
laiton fumé · oud brons · bronce viejo · ottone invecchiato ·
bronz antic · antiikkimessinki · patyna · antik piring
- 05** Aluminium gebürstet · brushed aluminium
aluminium balayé · geborsteld aluminium · aluminio pulido ·
alluminio spazzolato · aluminium lucios · harjattu alumiini ·
aluminium szczotkowane · alüminyum
- 06** Chrom · chrome
chrome · chroom · cromo · cromo · crom ·
kromi · chrom · krom
- 07** Nickel matt · nickel mat
nickel mat · nikkelt mat · níquel mate · nichel opaco ·
nichel mat · harjattu teräs · nikiel mat · mat nikel
- 08** Messing matt · brass mat
laiton mat · messing mat · bronce mate · ottone satinato ·
bronz mat · mattamessinki · mosiądz mat · mat piring
- 09** Kupferfarbig · copper
cuivré · koperkleurig · color cobre · colore rame · cupru ·
kuperinvärinen · kolorze miedzi · bakir renkli
- 10** Rot · red
rouge · rood · rojo · rosso · rosu ·
punainen · czerwony · kırmızı
- 11** Grau · grey
gris · grijs · gris · grigio · gri · harmaa · popielaty · gri
- 12** Blau · blue
bleu · blauw · azul · azzurro · gri · sininen · niebieski · mavi
- 13** Amber · amber
ambre · amber · ámbar · ambra · amber · meripihka ·
bursztynowy · amber
- 14** Braun · brown
brun · bruin · marron · marrone · maro · ruskea ·
brązowy · kahverengi
- 15** Grün · green
vert · groen · verde · verde · verde · vihreä · zielony · yeşil
- 16** Gelb · yellow
jaune · geel · amarillo · giallo · galben ·
keltainen · żółty · sarı
- 17** Mehrfarbig · multicolor
multicolore · multicolor · multicolor · multicolore ·
multicolor · monivärinen · multi-kolor · çok renkli
- 18** Orange · orange
orange · oranje · naranja · arancione · portocaliu ·
oranssi · pomarańczowy · turuncu
- 19** Türkis · turquoise
turquoise · turquoise · turquesa · turchese · turcoaz ·
turkoosi · turkusowy · turkuvaz
- 24** rostfarbig · rusty
rouille · roestkleur · óxido · ruggine · ruginiu · rustiikki ·
miedź · pas
- 26** Braun · brown
brun · bruin · marron · marrone · maro · ruskea ·
brązowy · kahverengi
- 27** Weiß antik · antique white
blanc antique · antiek wit · blanco decapé · bianco anticato ·
alb antic · antiikkivalkoinen · antyczny biały · antik beyaz
- 28** rostfarbig antik · antique rust
rouille antique · roestkleur antiek · oxido · ruggine anticato ·
ruginiu antic · rustiikki · antyczny rdzawy · antik pas rengi
- 29** Kupfer matt · copper mat
cuivre mat · koper mat · estera de cobre · rame opaco ·
cupru mat · kupari mat · miedź mat · bakir mat
- 30** holzfarbig · wood coloured
couleur bois · houtkleur · color maderá · colore di legno ·
culoare lemn · puunvärinen · kolor drewna · ahşap renk
- 31** Weiß matt · white mat
blanc mat · wit mat · estera blanca · bianco opaco · alb mat ·
valkoinen matto · biały mat · beyaz mat
- 32** Schwarz matt · black mat
noir mat · mat zwart · estera negra · nero opaco ·
negru mat · musta matto · czarny mat · siyah mat
- 34** Schwarz-Weiß · black and white
noir et blanc · zwart en wit · blanco y negro ·
nero e bianco · negru și alb · mustavalkoinen ·
biały i czarny
- 41** Taupe · taupe
taupe · taupe · gris pardo · taupe · taupe ·
ruskeanharmaa · ciemnoszary · taupe
- 42** Anthrazit · anthracite
antracite · antraciet · antracita · antracite · antracit ·
antrasiitti · antracyt · antrasit
- 45** Pastellblau · pastel blue ·
bleu pastel · pastel blauw · azul pastel · azzurro pastello ·
albastru pastel · pastellinsininen · pastelowy niebieski ·
pastel mavi
- 49** Pistaziengrün · pistachio green
vert pistache · pistachegroen · verde pistacho ·
verde pistacchio · verde fistic · pistaasin vihreä ·
zielony pistacjowy
- 51** Apfelgrün · applegreen
vert pomme · appelgroen · verde manzana · verde mela ·
verde mar · omenanvihreä · zielone jabłko · elma yeşili
- 52** Transparent klar · transparent clear
transparent claire · transparant helder · transparente claro ·
transparente chiaro · transparent clar · kirkas ·
przezroczysty · şeffaf

- 54** rauchfarbig · smoke
fumé · rookkleur · humo · fume' · fumuriu ·
savu · przydymiony · duman
- 56** Holz dunkel · old wood
vieux bois · oud hout · madera envejecida · legno antico ·
old wood (Lemn vechi) · vanha puu · stare drewno
- 57** Chrom bedampft · chrome plated
chromé · verchromd · acero cromado · cromato ·
cromat · kromattu · chromowany
- 61** Grau antik · antique grey
gris ancien · antiek grijs · gris antiguo · grigio antico ·
antic gri · antiikki harmaa · starodawny szary · antika gri
- 62** Kupfer antik · antique copper
cuivre ancien · antiek koper · cobre antiguo · rame antico ·
cupru antic · antiikki kupari · antyczne miedzi · antik bakır
- 64** Bronze · bronze
bronze · bronze · bronce · bronzo · bronz ·
pronssi · brąz · tunç
- 65** Coffee · coffee
café · koffie · café · caffè · cafea · antiikkiteräs · kawa
- 67** Nickel antik · nickel antique
nickel antique · antiek nikkell · níquel antiguo · nickel anticato ·
nichel antic · antiikkiteräs · aikiel antyczny · antik nikel
- 77** Ultimate Grau · ultimate grey
gris ultimate · ultiem grijs · gris absoluto · grigio assoluto ·
gri suprem · kultaa · ciemnoszary
- 78** betonfarbig · concrete look
couleur beton · beton kleur · color concreto ·
calcestruzzo · culoare beton · konkreettisia väri ·
konkretny kolor · beton rengi
- 79** goldfarbig · gold
or · goud · oro · oro · aur · kultaa · złota · altin
- 80** Schwarz-Gold · black-gold
noir et or · zwart-goud · negro-oro · oro nero ·
negru-auriu · musta-kulta · czarno złoty
- 83** Illuminate Gelb · illuminate yellow
jaune illuminate · helder geel · amarillo iluminado ·
giallo brillante · galben strălucitor · titaani · świetlisty złoty
- 87** titanfarbig · titan
titane · titaan · titán · titano · titaniu ·
titaani · tytanowy · titan
- 88** Silber antik · antique silver
argent antique · antiek zilver · plateado antiguo ·
argento anticato · argint antic · antiikkihopea ·
antyczne srebro · gümüş antika
- 89** silberfarbig · silver
argent · zilver · plata · argento · argint ·
hopea · srebrny · gümüş
- 91** Lila · lilac
lilla · lilla · lila · lilla · lila · lila · liliowy · leylak
- 92** Purpurrot · purple
pourpre · paars · púrpura · porpora · purpuriu ·
purppura · purpurowy · mor
- 93** Pink · pink
rose · pink · rosa · rosa · roz · pinkki · różowy · pembe
- 94** Pastelrosa · pastel pink ·
rose pastel · pastel rose · rosa pastel · rosa pastello ·
roz pastel · pastellin pinkki · pastelowy róż · pastel pembe

PRODUKTEIGENSCHAFTEN

Features · Caractéristiques · Kenmerken · Acabados · Caratteristiche · Caracteristici · Ominaisuudet · Cechy



Schalter · Switch

Interrupteur · Schakelaar · Interruptor · Interruttore · Intrerupator · Kytkin · Przełącznik



Fußschalter · Footswitch

interrupteur à pédale · Voetschakelaar · Interruptor de pie · interruttore a pedale · comutator picior · Päälle / pois jalkakytyn · wyłącznik nożny



Schnurschalter · Cable switch

Interrupteur de cordon · Snoerschakelaar · Cable de interruptor · Interruttore su cavo · Intrerupator cu cablu · katkaisin ja johto · Przełącznik na kablu



On/Off Touch Funktion · On/Off Touch function

Interrupteur tactile On/Off · Touch schakelaar On/Off · Función táctil On/Off · Interruttore touch On/Off · Intrerupator tactil On/Off · Kosketuskäyttöinen On/Off · Funkcja dotykowa On/Off



Getrennt schaltbar · Separately switchable

Interrupteurs séparés · Gescheiden schakelbaar · Interruptores separados · Interruttori separati · Intrerupatoare separate · Erikseen kytkettävissä · Oddzileny przełącznik



Fernbedienung · Remote control

Commande à distance · Afstandsbediening · Mando a distancia · Comando a distanza · Telecomanda · Kauko-ohjain · Pilot



Integrierter Dimmer · Integrated dimmer

Variateur intégré · Geïntegreerde dimmer · Regulador integrado · Dimmer integrato · Variator de lumina integrat · Integroitu himmennin · Wbudowany ściemniacz



Zugschalter · Pull switch

Interrupteur de trait · Trekschakelaar · Interruptor de tiro · Interruttore con tirata · Interupator de tragere · Vetokytkin · Przełącznik pociągany



Sensordimmer · Sensor dimmer

Variateur tactile · Touchdimmer · Regulador con sensor · Touchdimmer · Variator cu senzor · Kosketushimmennin · Czujnik ściemniania



Extern dimmbar · Externally dimmable

Dimmable avec variateur externe · Extern dimbaar · Dimmable por regulador externo · Dimmerabile con dimmer esterno · variator extern de lumina · himmennettävissä · Zewnętrznie ściemniania



RGB Farbwechsler · RGB Colorchanging

Changeement de couleur RGB · RGB Kleurverandering · Cambio de color RGB · Cambia colore RGB · Schimbator de culoare RGB · Värinvaihto RGB · Zmieniający kolor RGB



Lichtfarbe einstellbar · Adjustable light color

Couleur de lumière réglable · Lichtkleur instelbaar · Color de luz regulable · Colore della luce regolabile · Lumina colorata reglabila · Värilämpötila säädettävissä · Regulowana barwa światła



Höhenverstellbar · Adjustable height

Hauteur réglable · In hoogte verstelbaar · Altura regulable · Altezza regolabile · Inaltime reglabila · Säädettävä korkeus · Regulowana wysokość



Schwenkbar · Tilttable

Pivotant · Draaibaar · Pivotante · Girevole · Pivotant · Suunnattava · Skråtøny



Steckdose · Plug

Prise · Stekker · Enchufe · Spina · Priza · Katkaisin · Gniazdko



Vergößerung 3x · Magnification 3x

Magnification 3x · Vergroting 3x · Aumentos 3x · Ingrandimento 3x · Suplimentare 3x · Suurentava 3x · Powiększenie 3x



4 fach TOUCH · 4 level Touch function

Interrupteur tactile 4 niveaux · Touch schakelaar 4 niveaus · Función Táctil 4 nivel · Interruttore touch 4 livelli · Intrerupator tactil 4 nivele · Kosketuskäyttöinen 4 taso · Funkcja dotykowa 4 poziomy



Flexibel · Flexible

Flexible · Flexibel · Flexible · Flessibile · Flexibil · Joustava · Elastyczne



Kippbar · Tilttable

Inclinable · Kantelbaar · Basculante · Inclinabile · Basculant · Kallistettava · Uchylny



Lichtfarbe stufenlos einstellbar ·

Light color infinitely variable

Couleur de lumière infiniment variable · Lichtkleur traploos instelbaar · Color de luz infinitamente variable · Colore della luce infinitamente variabile · Culoare lumină infinit variabilă · Valon väri portaattomasti · Jasny kolor bezstopniowo



USB Anschluss · USB connection
Entrée USB · USB aansluiting · Conexión USB ·
Connessione USB · Conexiune USB · USB-liitäntä ·
Połączenie USB



USB Anschluss mit Ladefunktion ·
Recharging USB connection
Entrée USB de rechargement · Opladende USB
aansluiting · Conexión USB de recarga · Connessione
USB di ricarica · Conexiune USB reîncărcare ·
Lataaminen USB-liitäntä · ładowania USB połączenie



Nachtlicht · Night light
Veilleuse de nuit · Nachtlicht · Luz de la noche ·
Luce notturna · Lampă de noapte · Yyövalo ·
Lampka nocna



Gestensteuerung · Gesture control
Contrôle gestuel · Gebarenbediening · Control gestual ·
Controllo gestuale · Control prin gesturi/mișcarea mâinii ·
Kädellä ohjattava liiketunnistin · Sterowana gestami



Up and down Beleuchtung · Up and Down lighting
Point lumineux en haut et en bas · Lichtpunt boven en
onder · Luz de arriba y abajo · Luce su e giù · Sus și în
jos lumina · Ylös ja alas valoa · W górę iw dół światło



Dimmbar mit Schalter · Dimmable via switch
Réglable avec interrupteur · Dimbaar via schakelaar ·
Regulable mediante interruptor · Dimmerabile tramite
interruttore · Estompat prin comutator · Himmennettävä
kytkimen · Ściemnialne za pośrednictwem przełącznika



Musterschutz · Registered model
Modèle déposé · Beschermtd model ·
Modelo certificado · Modello depositato ·
Înregistrați model · Rekisteröity malli ·
Zarejestrowany wzór



Starlight Effekt · Starlight effect
Effet étoiles · Starlight effekt · Efecto estrella ·
Effetto stelle · Efect de "stele" · Tähti efekti ·
Efekt starlight



RGBW Farbwechsler · RGBW Colorchanging
Changement de couleur RGBW · RGBW Kleurverandering ·
Cambio de color RGBW · Cambia colore RGBW ·
Schimbator de culoare RGBW · Värinvaihto RGB ·
Zmieniający kolor RGBW



Ohne Leuchtmittel · Lamp(s) excluded
Sans ampoule(s) · Zonder lichtbron(nen) ·
Sin bombilla(s) · Lampadina Esclusa · Fara bec (s) ·
Ilman polttimo (s) · Bez żarówki (s)



LIFT ME
Innovative Höhenverstellung ohne Gegengewicht ·
Innovative height adjustment without counterweight ·
Nouveau! Réglage de la hauteur sans contrepoids ·
Innovatieve hoogteverstelling zonder contragewicht ·
Innovador sistema de ajuste de altura sin necesidad de
contrapeso · Regolazione innovativa dell'altezza senza
contrappeso · Ajustare inovativa a inaltimii fara
contragreutate · Innovatiivinen korkeuden säätö ilman
vastapainoa · Innowacyjna regulacja wysokości bez
przeciwwagi



SWITCH DIM TO WARM
Lichtfarbe mit Schalter einstellbar ·
Light color adjustable with switch
Couleur de lumière réglable avec interrupteur · Lichtkleur
instelbaar met schakelaar · Color de la luz ajustable con
interruptor · Colore della luce regolabile con interruttore ·
Culoarea luminii reglabila cu un comutator · Valon väri
säädettävällä kytkimellä · Kolor światła regulowane z
przełącznikiem



Ausziehbar · Extendible
extensible · Verlengbaar · Extensible ·
Estensibile · extensibila · Jatkettava ·
Rozsuwalny



Memory Funktion · Memory function
fonction mémoire · Geheugen functie ·
Función de memoria · Funzione memorizzazione ·
functia memorie · Muistitoiminto · Funkcja pamięci



indirekte Beleuchtung · indirect lighting
lumière indirecte · indirecte belichting ·
Iluminación indirecta · Illuminazione a scomparsa ·
iluminat indirect · epäsuora valaistus ·
oświetlenie pośrednie



DIP SWITCH
Lichtfarben direkt an der Leuchte einstellbar ·
Colours directly adjustable at the lamp
Les couleurs de la lumière peuvent être réglées
directement sur le luminaire · Lichtkleuren direct
instelbaar op de lamp · Tonalidades de luz ajustables
directamente en la lámpara · Colori della luce regolabili
direttamente sulla lampada · Culori ale luminii reglabile
direct de la bec · Valon väri asetettavissa suoraan
valaisimesta · Barwy światła można ustawić bezpośrednio
na oprawie

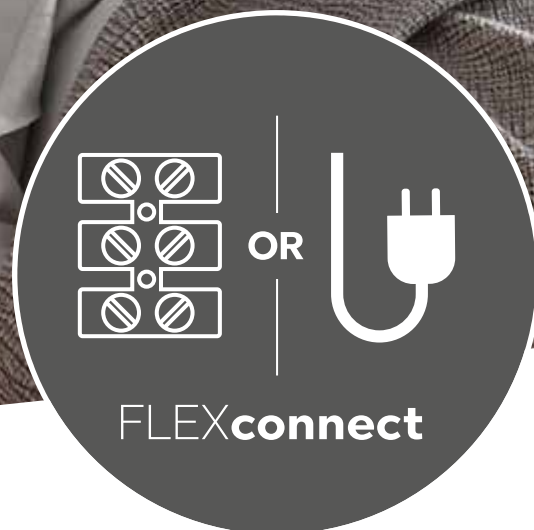

Ⓓ

Diese Wandleuchte ist sowohl für den Festanschluss, als auch für den Betrieb mit Steckerzuleitung geeignet.

ⒼⒻ

Deze wandlamp is zowel geschikt voor een vaste stroomaansluiting als voor het aansluiten van een plug-in voedingskabel.

ⒹⒺ

Aceasta aplica este potrivita atat pentru a fi montata direct la sursa de curent, dar si pentru a fi conectata printr-un cablu de curent la priza.

ⒼⒸ

This wall light is suitable both for a fixed power connection, as well as for the connection of a plug-in power cable.

ⒺⒶ

Esta luz de pared es adecuada tanto para una conexión de alimentación fija como para la conexión por cable de alimentación.

ⒻⒻ

Tämä seinävalaisin voidaan asentaa kiinteästi kytkentäriman avulla tai käyttämällä mukana tulevaa liitosjohtoa.

ⒻⒻ

Cette applique convient à la fois pour une connexion d'alimentation fixe, ainsi que pour la connexion d'un câble d'alimentation enfichable.

ⒻⒻ

Questa lampada da parete è adatta sia per una connessione di alimentazione fissa, sia per la connessione di un cavo di alimentazione plug-in.

ⒻⒻ

Ta lampa ścienna jest odpowiednia zarówno do podłączenia na stałe, jak również do eksploatacji przy użyciu przewodu z wtyczką.

DIP SWITCH

Mittels DIP SWITCH können 3 Lichtfarben (warmweiß, neutralweiß und kaltweiß) über einen Schalter direkt an der Leuchte eingestellt werden.

The DIP SWITCH directly sets the luminaire's three light colours (warm, neutral and cool white).



Warmweiß | Warm white



Neutralweiß | Neutral white

Kaltweiß | Cool white

581

LED SWITCH DIMMER

DIMMEN OHNE DIMMER | DIMMING WITHOUT DIMMER

Helligkeit bequem mit jedem herkömmlichen Lichtschalter einstellbar.

Adjusting the desired level of brightness with any conventional light switch.



100%

on
1x
off

Licht einschalten
Switch on the light

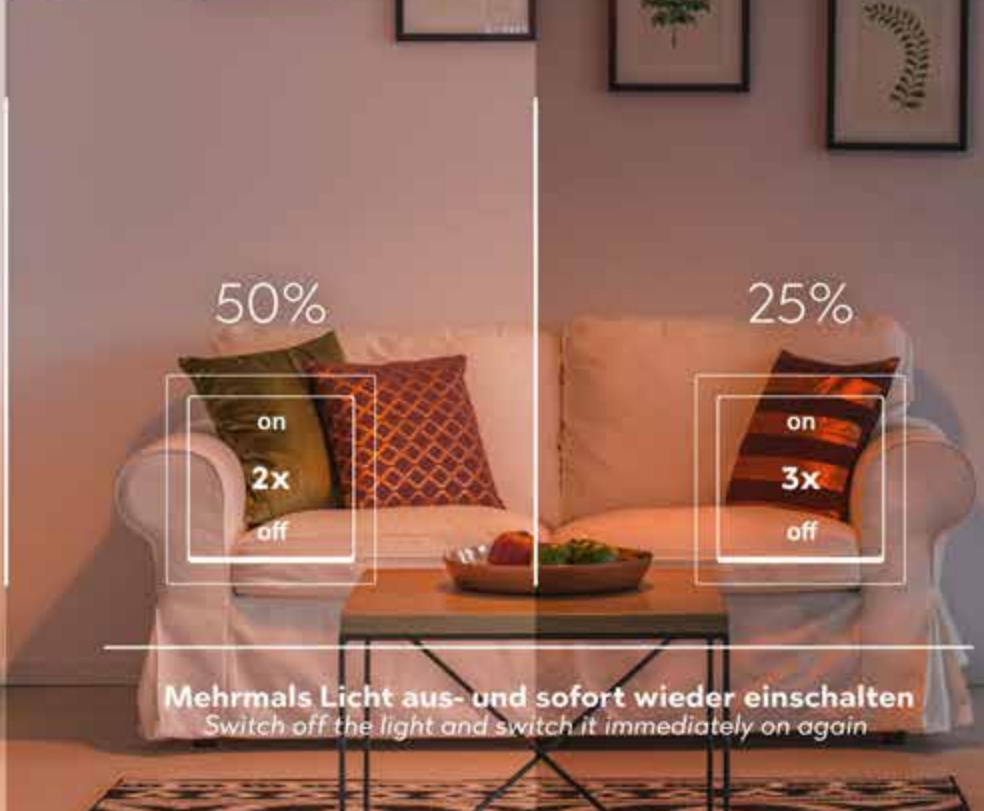

50%

on
2x
off

Mehrmals Licht aus- und sofort wieder einschalten
Switch off the light and switch it immediately on again

25%

on
3x
off

DIGITAL AN IHRER SEITE

NUMÉRIQUEMENT À VOS CÔTÉS · DIGITAAL AAN UW KANT · ACOMPAÑAMIENTO DIGITAL ·
DIGITALMENTE AL VOSTRO FIANCO · DIGITAL LA ÎNDEMÂNĂ DUMNEAVOASTRĂ ·
DIGITAALISUUS PUOLELLASI · CYFROWO PO TWOJEJ STRONIE

(FR)

L'élément du succès numérique au service d'une communication moderne – notre portail B2B myTRIO.

Avantages offerts aux partenaires commerciaux enregistrés.

Bénéficiez de notre assistance simple et rapide ! En un clic vous accédez à toutes les données d'éléments importants et pourrez facilement télécharger des fichiers. Découvrez ces avantages sur notre portail B2B numérique myTRIO. Les utilisateurs enregistrés y trouveront toutes les informations pertinentes sur nos produits, des détails techniques aux images et la quantité de produits en stock. Vous n'êtes pas encore enregistré ? N'hésitez pas à nous contacter.

582

(NL)

Het digitale succeselement voor moderne communicatie – ons B2B-portaal myTRIO.

Voordelen voor geregistreerde zakenpartners.

Profiteer van onze snelle en ongecompliceerde ondersteuning! Met slechts één klik hebt u toegang tot alle belangrijke artikelgegevens en kunt u eenvoudig bestanden downloaden. Ontdek deze voordelen in ons digitale B2B-portaal myTRIO. Geregistreerde gebruikers vinden er alle relevante informatie over onze producten, van technische details tot afbeeldingen en voorraadniveaus. Bent u nog niet geregistreerd? Aarzel niet om contact op te nemen met ons.

(ES)

El Elemento de Éxito Digital para la Comunicación Moderna: nuestro portal myTRIO B2B.

Ventajas para socios comerciales registrados.

¡Disfrute de los beneficios de nuestra asistencia rápida y sencilla! Con un solo clic, tendrá acceso a toda la información importante del artículo y podrá descargar los archivos sin inconvenientes. Descubra estos beneficios en nuestro portal myTRIO digital B2B. Los usuarios registrados encontrarán toda la información importante sobre nuestros productos en el portal, desde los detalles técnicos hasta las imágenes y la cantidad de productos en stock. ¿Todavía no está registrado? No dude en consultarnos.

(IT)

Il nostro portale B2B myTRIO: il fattore di successo digitale per una comunicazione moderna.

Vantaggi per i partner commerciali registrati.

Usufruisce della nostra assistenza, rapida e semplice! Basta un clic per avere accesso a tutti i dati più importanti sui prodotti e per scaricare con facilità i file. Vieni a scoprire questi vantaggi nel nostro portale digitale B2B myTRIO. Gli utenti registrati troveranno informazioni dettagliate sui nostri prodotti, dalle specifiche tecniche alle immagini fino alle giacenze di magazzino. Ancora non sei registrato? Non esitare a contattarci.



(RO)

Elementul de succes digital pentru comunicare modernă – portalul B2B myTRIO.

Avantaje pentru mărcile partenere înregistrate.

Beneficiați de asistența noastră rapidă și extrem de simplă! Cu un singur clic puteți avea acces la toate datele privind produsele importante și puteți descărca ușor fișiere. Descoperiți aceste avantaje în portalul B2B digital myTRIO. Aici, utilizatorii înregistrați pot găsi toate informațiile relevante despre produsele noastre, de la detalii tehnice la imagini și numărul de produse aflate în stoc. Încă nu v-ați înregistrat? Nu ezitați să ne contactați.

(FI)

Digitaalinen menestyksenkäs elementtimme modernilla tiedonvälityksellä — TRIO B2B Partners -portaalimme.

Etuja rekisteröidyille liiketoimintakumppaneille.

Etua nopeasta ja toimivasta tuestamme! Vain yhdellä napsautuksella saat tärkeitä tietoja ja voit ladata helposti tiedostoja. Tutustu näihin etuihin myTRIO digital B2B -portaalissamme. Rekisteröityneet käyttäjät löytävät kaikki mahdolliset tiedot tuotteistamme, tekniset tiedot, kuvat tuotteistamme ja varastossa olevien tuotteiden määrän. Etkö ole vielä rekisteröitynyt? Voit aina ottaa meihin yhteyttä.

(PL)

Cyfrowy element sukcesu na rzecz nowoczesnej komunikacji – oto nasz portal B2B myTRIO.

Korzyści dla zarejestrowanych partnerów biznesowych.

Skorzystaj z naszego szybkiego i prostego wsparcia! Wystarczy jedno kliknięcie, a zyskasz dostęp do wszystkich istotnych danych wybranego elementu i możesz wygodnie pobierać pliki. Odkryj te korzyści na naszym cyfrowym portalu B2B myTRIO. Zarejestrowani użytkownicy znajdują tam wszystkie ważne informacje o naszych produktach – od szczegółów technicznych aż po zdjęcia i stany magazynowe. Nie jesteś jeszcze zarejestrowany? Zachęcamy do skontaktowania się z nami.

(FR)

Vous pouvez également nous consulter depuis le confort de votre propre maison !

Plongez-vous dans le monde virtuel et explorez notre showroom grâce à une visite interactive à 360°. Que ce soit sur un PC, une tablette ou un smartphone, la visite est directement disponible sur votre navigateur internet. La présentation est particulièrement impressionnante si vous utilisez des lunettes de réalité virtuelle. Vous trouverez davantage d'informations sur notre site internet. N'hésitez pas à le visiter et à profiter de l'expérience. Profitez-en !

(NL)

Bezoek ons ook vanuit het comfort van uw eigen huis!

Duik in de virtuele wereld en verken onze showroom met onze interactieve 360°-rondleiding. Of het nu op een pc, tablet of smartphone is, de tocht is direct voor u beschikbaar in uw webbrowser. De presentatie is vooral indrukwekkend, wanneer u een VR-bril gebruikt. Meer informatie vindt u op onze website. Kom gerust even langs en geniet van de ervaring. Veel plezier!

(ES)

¡También nos puede visitar desde la comodidad de su propio hogar!

Sumérjase en el mundo virtual y explore nuestra sala de exposiciones con una visita interactiva de 360°. La visita está disponible en su navegador web y puede acceder desde su PC, tablet o teléfono inteligente. La presentación se torna especialmente interesante si usa las gafas de realidad virtual. Puede encontrar más información en nuestro sitio web. Está invitado a visitarlo y disfrutar de la experiencia. ¡Que lo disfrute!

(IT)

Puoi venire a trovare anche comodamente da casa tua!

Fai un salto nell'universo virtuale ed entra nel nostro showroom partecipando al nostro tour interattivo a 360°. Da PC, tablet o smartphone, il tour è disponibile direttamente nel browser web. L'esperienza sarà particolarmente suggestiva se utilizzerai gli occhiali VR. Per ulteriori informazioni, visita il nostro sito web. Vieni a trovarci e lasciati incantare da questa esperienza. E buon divertimento!

(RO)

De asemenea, puteți să ne vizitați din confortul casei dumneavoastră!

Pătrundeți în lumea virtuală și explorați magazinul nostru de prezentare cu ajutorul turului interactiv de 360°. Pe computer, tabletă sau telefonul inteligent, turul este disponibil direct în browserul web. Prezentarea devine în mod special impresionantă dacă folosiți ochelari VR. Puteți găsi mai multe informații pe site-ul nostru web. Nu ezitați să faceți o vizită și să vă bucurați de experiență. Distracție plăcută!

(FI)

Voit myös tavoittaa meidät Comfort of Your Own Home -sivustosta!

Lähde virtuaaliseen maailmaan ja katso esittelytilaamme 360 asteen interaktiivisella kierroksella. Voit nähdä kaiken tietokoneesii, älypuhelimesi tai tablettisi selaimella. Esitys on erityisen näyttävä, jos sinulla on VR-lasit. Lisätietoja löydät verkkosivustoltamme. Voit välillä keskeyttää ja jatkaa taas. Nauti!

(PL)

Możesz także odwiedzić nas, przebywając w zaciszu własnego domu!

Zanurz się w wirtualnym świecie i odkryj nasz salon wystawowy produktów na sprzedaż dzięki interaktywnej wycieczce 360°. Skorzystaj z komputera, tabletu lub smartfona – wycieczka jest dostępna bezpośrednio w przeglądarce internetowej. Prezentacja będzie szczególnie imponująca, jeśli użyjesz okularów VR. Więcej informacji można znaleźć na naszej stronie internetowej. Zapraszamy – wstąp do nas i zobacz, co dla Ciebie przygotowaliśmy. Życzymy przyjemnie spędzonego czasu!



GET YOUR LIGHT CONNECTED.

FR NL ES IT RO FI PL

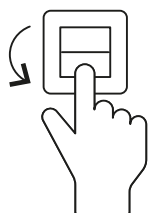

WiZ CLICK

Simple et efficace. Deux modes d'éclairage préférés peuvent être commandés via l'interrupteur d'éclairage existant.

Eenvoudig en effectief. Twee voorkeurstellingen kunnen worden bediend via de bestaande lichtschakelaar.

Helppoa ja tehokasta. Kaksi toivottua valo asetusta jota voidaan käyttää seinäkytkimellä.

Simplu si efectiv. Pot fi operate 2 moduri de iluminat preferate prin comutatorul de lumina existent.

Semplice ed efficace. È possibile utilizzare due modalità di illuminazione preferite tramite l'interruttore della luce esistente.

Simple y efectivo. Dos ambientes de luz preferidos pueden operar a través del interruptor convencional.

Proste i efektywne. Dwa preferowane tryby oświetlenia można obsługiwać za pomocą dostępnego przełącznika oświetlenia.

Controlul luminilor prin programarea orei/timpului ,cu senzori sau printr-o simpla comanda verbala.Compatibil cu Amazon Alexa si Google Home.

Controllo delle luci secondo gli orari, con sensori o semplici comandi verbali. Compatibile con Amazon Alexa e Google Home.

Control de las luces con horarios, con sensores o por simples comandos de voz. Compatible con Alexa de Amazon y Google Home.

Ustawianie i sterowanie lampami za pomocą harmonogramów.

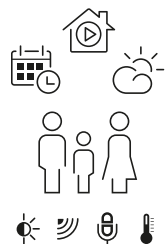

WiZ MAGIC

Contrôle des lumières par programme horraire, par capteurs ou par simples commandes vocales. Compatible avec Amazon Alexa et Google Home.

Aansturing van de lampen met tijdschema's, door sensoren of via eenvoudige spraakopdrachten. Compatibel met Amazon Alexa en Google Home.

Valoja voi säätää aikataulutetusti, sensoreilla tai yksinkertaisilla ääni komennoilla. Yhteensopiva Amazon Alexan ja Google Homen kanssa.

Facile e veloce da installare.Piena funzionalità e flessibilità con l'App Wiz disponibile su App Store e su Google Play.

Fácil y rápido de instalar. Amplia funcionalidad y flexibilidad con la aplicación WiZ, disponible en la App Store o en Google Play.

Prosta i szybka instalacja. Pełna funkcjonalność i elastyczność dzięki aplikacji WiZ – dostępnej w App Store lub Google Play.



WiZ APP

Installation facile et rapide. Toutes les fonctionnalités et flexibilité disponible avec l'application WiZ, téléchargeable sur App Store ou Google Play.

Eenvoudig en snel te installeren. Volledige functionaliteit en flexibilititeit met de WiZ-app - beschikbaar in de App Store of op Google Play.

Helppo ja nopea asentaa. Käyttö WiZ-aplikaatiolla - saatavissa App Storesta tai Google Play kaupasta.

Instalare usoara si rapida.Functionalitate completa si flexibilitate cu WIZ App -disponibil pe App store sau pe Google Play.

Controllo tramite telecomando e possibilità di salvare quattro modalità luce preferite.

Control via mando a distanza y con posibilidad de guardar 4 ambientes favoritos.

Możliwość sterowania za pomocą pilota i zapisywania czterech preferowanych trybów oświetlenia.



WiZ MOTE

Contrôle via la télécommande et possibilité de sauvegarder quatre modes d'éclairage favoris.

Aansturen via de afstandsbediening en mogelijkheid om vier favoriete licht instellingen te bewaren.

Toimintojen säätö kaukosäätimellä ja mahdollisuus tallentaa neljä valo asetusta.

Controlul prin telecomanda si posibilitatea de a memora/salva 4 moduri favorite.

Résidences multiples

Contrôlez et commandez plusieurs résidences simultanément et de n'importe où. Que ce soit votre propre maison ou votre deuxième résidence.

Meerdere locaties

Controleren en aansturen van meerdere locaties tegelijkertijd en van overal. Uw thuis of uw vakantiehuis.

Useita sijainteja

Voit hallita useita sijainteja, kotiasi tai kesäasuntoasi samanaikaisesti.

Locatii Multiple

Control si comanda a locatiilor multiple simultan si de oriunde .Fie ca te afli acasa sau in casa de vacanta

Molteplici Location

Controlla e comanda più sedi contemporaneamente e da qualsiasi luogo. Che tu sia casa tua o la tua casa vacanza.

Múltiples localizaciones

Control y cambio en múltiples localizaciones simultáneamente, tanto tu casa como en tu segunda residencia.

Kilka lokalizacji

Kontrola i sterowanie z kilku lokalizacji jednocześnie i zewsząd. Czy to z własnego domu, czy też z wakacyjnego mieszkania.



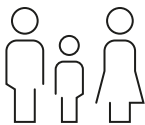

Multiplés utilisateurs

Le nombre de personnes pour contrôler les lumières peut être déterminé individuellement.

Meerdere gebruikers

Het aantal personen dat de lampen aanstuurt, kan individueel worden ingesteld.

Monta eri käyttäjää

WiZ käyttäjien määrä voidaan yksilöllisesti määrittää.

Utilizatori multipli

Numarul de persoane care sa controleze luminile poate fi setat individual.

Molteplici Utenti

Il numero di persone per controllare le luci può essere impostato individualmente.

Múltiples usuarios

El número de personas que controlan las luces se puede configurar individualmente.

Kilku użytkowników

Liczba użytkowników mogących sterować lampami może być określana indywidualnie.



Basé sur le cloud

WiZ se connecte au cloud pour stocker les préférences, partager les désirs et générer automatiquement des mises à jour.

Cloud gebaseerd

WiZ maakt verbinding met de cloud om voorkeuren op te slaan, wensen te delen en automatische updates te genereren.

Pilvipalveluun perustuva

WiZ ottaa yhteyden pilvipalveluun, tallentaa asetukset ja luo päivitykset automaattisesti.

Pe baza de Cloud

WiZ te conectează la Cloud la magazinul preferat, transmite dorințele și generează update-uri în mod automat.

Basato sul Cloud

WiZ si connette al cloud per memorizzare le preferenze, condividere desideri e generare automaticamente gli aggiornamenti.

Basado en la nube

WiZ conecta con la nube para guardar tus preferencias, comparte y genera actualizaciones automáticamente.

Oparte na chmurze

WiZ łączy się z chmurą, aby zapisywać preferencje, rozdzielać życzenia i automatycznie generować aktualizacje.



Lieux multiples

Toutes les lumières peuvent être assignées à différentes pièces et contrôlées avec précision - individuellement ou en groupe.

Meerder woonruimtes

Alle lampen kunnen worden toegewezen aan verschillende woonruimtes en nauwkeurig worden aangestuurd - individueel of in groepen.

Useita huoneita

Jokainen valo voidaan määrittää eri huoneelle. Hallittavissa ryhmissä tai yksittäin.

Câteva camere

Toate luminile pot fi atribuite mai multor camere diferite și pot fi controlate cu precizie - individual și în grupuri.

Numerose stanze

Tutte le luci possono essere assegnate a stanze diverse e controllate con precisione - individualmente o in gruppi.

Varias habitaciones

Todas las luces pueden ser asignadas a diferentes habitaciones y controladas con precisión - individualmente o en grupo.

Kilka pomieszczeń

Wszystkie lampy mogą być przyporządkowywane do różnych pomieszczeń i precyzyjnie sterowane – pojedynczo lub w grupach.



Pas besoin de pont

Il n'y a pas besoin d'un dispositif supplémentaire pour contrôler les lumières.

Geen hub nodig

Er is geen extra apparaat nodig om de lampen aan te sturen.

Ei tarvetta erilliselle keskukselle

Ei tarvetta erilliselle keskukselle valojen säätämiseen.

Nu e nevoie de nici un punct central

Nu e nevoie de o punte sau hub pentru a controla luminile.

Non sono necessari altri hub

Non è necessario un ponte o un hub aggiuntivo per controllare le luci.

No necesaria una unidad central

No es necesario una conexión adicional o unidad central para controlar las luces.

Bez konieczności stosowania dodatkowych mostków

Do sterowania lampami nie jest potrzebny żaden dodatkowy mostek.



Technologie WiFi

WiZ utilise la technologie WiFi comme une solution sans fil sécurisée, indépendante, abordable et facile à installer.

WiFi-technologie

WiZ gebruikt Wi-Fi-technologie als een veilige, onafhankelijke, betaalbare en eenvoudig te installeren draadloze oplossing.

WiFi teknologia

WiZ käyttää Wi-Fi teknologiaa turvallisena, itsenäisenä, edullisena ja helppo käyttöisenä langattomana ratkaisuna.

Technologie WiFi

WiZ folosește tehnologia Wi-Fi ca o soluție de internet sigură, independentă, permisivă și ușor de instalat.

Tecnologia Wi-Fi

WiZ utilizza la tecnologia Wi-Fi come soluzione wireless sicura, indipendente, economica e facile da installare.

Tecnología Wi-Fi

WiZ utiliza la tecnología Wi-Fi como una solución inalámbrica segura, independiente, asequible y fácil de instalar.

Technologia WLAN

WiZ używa technologii „WLAN” jako bezpiecznego, niezależnego, niskonakładowego i łatwego w instalacji rozwiązania radiowego.

DUOLINE

Système de voie à deux phases (230 V) · 2-fase-spoorsysteem (230 V) · Sistema de rieles en 2 fases (230 V) · Sistema a binario bifase (230 V) · Sistem de piste cu 2 faze (230 V) · 2-vaihekiskojärjestelmä (230 V) · 2-fazowy system prowdnic (230 V)

FR NL ES IT RO FI PL

⚠ Lors de la planification, veuillez prêter une attention particulière à la position du conducteur de protection, qui doit être connecté en permanence dans le système.

Let bij de planning absoluut op de positie van de beschermende geleider die binnen het systeem ononderbroken verbonden moet zijn.

Al planificar, por favor, tenga en cuenta la posición de la toma de tierra, que debe estar conectado a lo largo de todo el sistema.

In fase di progettazione, prestare attenzione alla posizione del conduttore di protezione, che deve essere collegato in modo continuo all'interno dell'impianto.

La planificare, luați neapărat în considerare poziția conductorului de protecție, care trebuie să fie conectat continuu în interiorul sistemului.

Huomioi suunnittelussa koko järjestelmään kytkettävän suojamaadoituksen sijainti.

Podczas projektowania należy zwrócić uwagę na położenie przewodu ochronnego, który musi być podłączony w całym systemie.

1 Rail

La longueur maximale de l'installation est de 30 mètres par alimentation, avec une puissance totale maximale de 600 watts par phase.

Spoor

De maximale montagelengte bedraagt 30 meter per voeding, bij een een totaal vermogen van max. 600 watt per fase.

Riel

La longitud máxima de montaje es de 30 metros por alimentación, con una potencia total de 600 vatios como máximo por fase.

Binario

La lunghezza massima di installazione è di 30 metri per ogni alimentazione, con una potenza totale di max. 600 watt per fase.

Pistă

Lungimea maximă de montaj este de 30 de metri pe fiecare sursă de alimentare, la o putere totală de max. 600 W pe fază.

Kisko

Asennuksen enimmäispituus on 30 metriä syöttöä kohti, kokonaisteho enintään 600 W/vaihe.

Szyna

Maksymalna długość montażu wynosi 30 metrów na linię zasilania z łączną mocą 600 watów na jedną fazę.

Midden-/eindevoeiding met elektronische fasewisselaar

Door middel van een elektronische fasewisselaar kunnen de twee fasen ook bij driedradige stroomleidingen apart geschakeld en gedimd worden.

Alimentación medios/extremos con cambiador de fase electrónico

Por medio de los cambiadores de fase electrónicos, las dos fases pueden activarse y atenuarse también mediante cables de corriente de tres filamentos.

Alimentazione centrale/finale con variatore di fase elettrico

Mediante un variatore di fase elettrico, le due fasi possono essere commutate e dimmerate separatamente, anche con linee di alimentazione a tre conduttori.

Alimentare centrală/finală cu schimbător electronic de fază

Prin intermediul dispozitivului electronic de schimbare a fazelor se pot comuta și regla două faze chiar și în cazul cablurilor electrice cu trei fire.

Keski-/päätyyöttö elektronisella vaihtimella

Sähköistä vaihdinta käyttämällä nämä kaksi vaihetta voidaan kytkeä ja himmentää erikseen jopa kolmijohtimisella kaapeloinnilla.

Zasilanie pośrednie / końcowe z elektronicznym przełącznikiem faz

Za pomocą elektronicznych zmieniaaczy faz obie fazy można przełączać i przyciemniać osobno, nawet w przypadku trójprzewodowych linii zasilania.

2 Profil encastré

Verzonken profiel

Perfil empotrado

Profilo incassato

Profil încastrat

Upotettu profiili

Profil wpuszczany

3 Alimentation électrique intermédiaire/finale

L'alimentation du milieu/extrémité est montée directement au-dessus de la prise de courant et permet de connecter des rails d'un côté ou des deux côtés.

Midden-/eindevoeiding

De midden-/eindevoeiding wordt direct over de stroomuitgang aangebracht en maakt het mogelijk sporen op één of beide kanten aan te sluiten.

Alimentación medios/extremos

La alimentación de medios/extremos se adapta directamente mediante la toma de corriente, y permite que las lámparas se conecten por un lado o por los dos.

Alimentazione centrale/finale

L'alimentazione centrale/finale è montata direttamente sopra la presa di corrente e consente di collegare le guide su un lato o su entrambi i lati.

Alimentare centrală/finală

Alimentare centrală/finală este realizată direct prin intermediul conexiunii electrice și permite conectarea pistelor pe o parte sau pe ambele părți.

Keski-/päätyyöttö

Keski/päätyyöttö asennetaan suoraan pistorasian yläpuolelle, ja se mahdollistaa kiskojen kytkemisen toiselle tai molemmille puolille.

Zasilanie pośrednie / końcowe

Zasilanie środkowe / końcowe jest instalowane bezpośrednio nad gniazdem zasilania i umożliwia podłączenie szyn z jednej lub z obu stron.

5 Connecteur longitudinal

Relie deux rails entre eux pour des sections droites.

Longitudale verbinder

Verbindt twee sporen voor rechte stukken met elkaar.

Ensamblaje recto

Ensamble dos rieles para tramos rectos entre sí.

Connettore longitudinale

Unisce due binari per sezioni rettilinee.

Conector longitudinal

Conectează două piste pentru trasee drepte unele cu altele.

Suora liitin

Yhdistää kaksi kiskoa suoria osuuksia varten.

Przedłużacz

Łączy dwie szyny dla prostych odcinków.

6 Connecteur Flex

Relie deux rails entre eux sous n'importe quel angle et relie le montage au plafond à celui au mur.

Flexibele verbinder

Verbindt twee sporen in een willekeurige hoek met elkaar en maakt de verbinding tussen plafond- en muurmontage mogelijk.

Ensamblaje flexible

Ensamble dos rieles con cualquier ángulo entre sí y permite la conexión entre el montaje en techo y paredes.

Connettore flessibile

Collega tra loro due binari con qualsiasi angolazione e consente il collegamento tra il montaggio a soffitto e a parete.

Conector Flex

Conectează două șine într-un unghi aleatoriu între ele și permite conectarea între sistemele de montaj pe plafon și pe perete.

Flex-liitin

Yhdistää kaksi kiskoa mihin tahansa kulmaan ja mahdollistaa yhteyden katto- ja seinäkiinnityksen välillä.

Łącznik elastyczny

Łączy dwie szyny pod dowolnym kątem i umożliwia połączenie między sufitem a ścianą.

4 Alimentation intermédiaire/finale avec changeur de phase électronique

Grâce à un changeur de phase électronique, les deux phases peuvent être commutées et atténuées séparément, même avec des lignes électriques à trois conducteurs.

7 Raccord en L

8 Relie deux rails entre eux à angle droit.

L-Connector

Verbindt twee sporen in een rechte hoek met elkaar.

Conector en L

Ensamble dos rieles en ángulo recto entre si.

Connettore a L

Collega insieme due binari ad angolo retto.

Conector în L

Conectează două piste pentru trasee în unghi drept unele cu altele.

L-Liitin

Yhdistää kaksi kiskoja toisiinsa suorassa kulmassa.

Złącze L

Łączy dwie szyny pod kątem prostym.

9 Raccord en T

10 Relie trois rails entre eux à angle droit.

T-Connector

Verbindt drie sporen in een rechte hoek met elkaar.

Conector en T

Ensamble tres rieles en ángulo recto entre si.

Connettore a T

Collega insieme tre binari ad angolo retto.

Conector în T

Conectează trei șine în unghi drept unele de altele.

T-Liitin

Yhdistää kolme kiskoja suorassa kulmassa toisiinsa.

Złącze T

Łączy trzy szyny pod kątem prostym.

12 Connecteur X

Relie quatre rails entre eux à angle droit.

X-verbinder

Verbindt vier sporen in een rechte hoek met elkaar.

Ensamblaje en X

Ensamble cuatro rieles en ángulo recto entre si.

Connettore a X

Collega insieme quattro binari ad angolo retto.

Conector X

Conectează patru șine în unghi drept între ele.

X-liitin

Yhdistää neljä kiskoja suorassa kulmassa toisiinsa nähden.

Łącznik X

Łączy cztery szyny pod kątem prostym.

13 Adaptateur pendulaire

14 Cet adaptateur pendulaire permet d'intégrer des luminaires suspendus conventionnels dans le système de rail DUOline.

Hangadapter

Deze hangadapter maakt het mogelijk gewone hanglampen in het DUOline-spoorsysteem te integreren.

Adaptador colgante

Este adaptador colgante le permite integrar las lámparas colgantes convencionales en el sistema de rieles de DUOline.

Adattatore per sospensione

Questo adattatore per sospensione consente l'integrazione di lampade a sospensione convenzionali nel sistema a binario DUOline.

Adaptor lustre

Acest adaptor pendular permite integrarea lustrelor uzuale în sistemul de piste DUOline.

Riippuvalaisinsovitin

Tämä riippuvalaisinsovitin mahdollistaa tavallisten riippuvalaisimien integroinnin DUOline-kiskojärjestelmään.

Adapter zawieszania

Ten adapter do zawieszania umożliwia zintegrowanie tradycyjnych lamp wiszących z systemem szyn DUOline.

15 Raccourcisseur de câble

Permet de raccourcir les câbles des luminaires suspendus.

Snoerverkorter

Maakt het inkorten van het snoer van hanglampen mogelijk.

Acortador de cable

Es posible acortar el cable de las lámparas colgantes.

Sistema per accorciare il cavo

Permette di accorciare i cavi delle lampade a sospensione.

Prescurtare cablu

Permite scurtearea cablurilor lustrelor.

Johdon lyhennin

Mahdollistaa riippuvalaisimen johdon lyhentämisen.

Skracacz kabla

Pozwala skrócić kable lamp wiszących.

16 Suspension**17 Afstandhouder****Suspensión****Sospensione****Suspensie****Ripustus****Zawieszenie****18 Embouts****Eindkappen****Tapones****Tappi terminali****Capace de capăt****Päätykappaleet****Zaślepki****19 Couvercle de remplacement de l'adaptateur****Vervangende afdekking voor adapter****Tapa de recambio para adaptador****Coperchio di ricambio per adattatore****Capac de înlocuire pentru adaptor****Adapterin korvaava suojus****Wymienna pokrywa adaptera****20 Isolateur**

Grâce à un isolateur, deux circuits séparés peuvent être reliés optiquement pour former un système.

Isolator

Door middel van de isolator kunnen twee aparte stroomkringen optisch verbonden worden tot één systeem.

Aislador

Por medio del aislador pueden conectarse dos circuitos de forma óptica a un sistema.

Isolatore

Utilizzando un isolatore, due circuiti separati possono essere collegati otticamente per formare un sistema.

Izolator

Prin intermediul izolatorului este posibilă conectarea optică a două circuite de comutare într-un sistem.

Eristin

Eristimen avulla kaksi erillistä piiriä voidaan kytkeä optisesti yhden järjestelmän muodostamiseksi.

Izolator

Za pomocą izolatora można optycznie połączyć dwa oddzielne obwody w celu utworzenia systemu.

21 Alimentation électrique flexible

L'alimentation électrique flexible est nécessaire si les rails ne peuvent pas être posés directement sur la prise de courant.

Flexibele stroomtoevoer

Flexibele stroomtoevoer is nodig, als de sporen niet direct over de stroomuitgang gelegd kunnen worden.

Suministro de corriente flexible

El suministro de corriente flexible será necesario si las lámparas no pueden desplegarse directamente sobre la toma de corriente.

Sistema di alimentazione flessibile

Il sistema di alimentazione flessibile è necessario se i binari non possono essere posati direttamente sulla presa di corrente.

Alimentarea electrică flexibilă

Alimentarea electrică flexibilă este necesară atunci când pistele nu pot fi pozate direct prin intermediul racordului electric.

Joustava virransyöttö

Joustava virtalähde on tarpeen, jos kiskoja ei voida asentaa suoraan pistorasian yläpuolelle.

Elastyczne zasilanie

Elastyczny zasilanie jest wymagane, jeśli szyny nie mogą być układane bezpośrednio nad gniazdem zasilania.

INDEX · NUMERIC

Seite Page	Artikel-Nr. Product No.	EAN-Nummer EAN-Number	Ersatzteile Spare parts	Seite Page	Artikel-Nr. Product No.	EAN-Nummer EAN-Number	Ersatzteile Spare parts
156	101000324	4017807504675	G1010-01	193	212870236	4017807567977	S21282-01
156	101000524	4017807504682	G1010-01				T2128-00
243	101600506	4017807430165		193	212879236	4017807567960	S21281-01
243	101600806	4017807430172					T2128-00
249	101700332	4017807522730		382	214470107	4017807539493	S2144-01
249	101700532	4017807522747		382	214470108	4017807539523	S2144-01
240	102000403	4017807387919		382	214470132	4017807539554	S2144-01
240	102000405	4017807387926		351	220810201	4017807258363	92335
248	110600331	4017807343656		351	220810205	4017807258370	92335
248	110600531	4017807343670		358	222370231	4017807387025	
160	110700328	4017807354140	92809	358	222370232	4017807387032	
160	110700528	4017807354164	92809	359	222570231	4017807399875	
362	200200132	4017807463019		359	222570232	4017807399882	
363	200300132	4017807462982		348	223310105	4017807371765	T2233-00
362	200600132	4017807462821	S2006-02	348	223310131	4017807371772	T2233-00
161	200700128	4017807354188	92809	348	223310132	4017807371789	T2233-00
364	200970124	4017807211832	92396	349	223410131	4017807303025	
367	201000101	4017807409642		349	223410132	4017807306309	
366	201100201	4017807409666		90	223510131	4017807421859	
116	201200100	4017807398632	92854	90	223510132	4017807421910	
112	202000108	4017807436051	G2020-01	90	223510231	4017807421965	
110	202000132	4017807506372	G2020-01	90	223510232	4017807421996	
110	202000142	4017807432893	G2020-54	180	223710130	4017807441871	
117	202500101	4017807364927	92831-20	180	223790130	4017807441895	
369	202620131	4017807575057		355	224110179	4017807329018	
369	202620132	4017807575040		346	224210102	4017807465914	T2242-01
368	202670107	4017807524017		346	224290102	4017807465921	T2242-01
368	202670108	4017807526547		352	224810132	4017807502756	
368	202670131	4017807524055		352	224810167	4017807502763	
368	202670132	4017807524079		352	224819132	4017807502787	
188	203000132	4017807522716		352	224819167	4017807502794	
115	204400101	4017807364972	92830-22	348	224910231	4017807454413	
182	205570167	4017807442540		348	224910232	4017807454437	
182	205570267	4017807442564		347	225172924	4017807404517	T22511-00
354	206400279	4017807364361		347	225172931	4017807404555	T22511-00
354	206500279	4017807364378		347	225172942	4017807433401	T22511-00
154	208070132	4017807407242		347	225174724	4017807404586	T22512-00
423	208870132	4017807388473		347	225174731	4017807404593	T22512-00
122	209100107	4017807398564	S5091-01	347	225174742	4017807433425	T22512-00
122	209100108	4017807398571	S5091-01	360	225210104	4017807256314	
114	212200100	4017807522013	G2122-52	360	225210107	4017807256338	
467	212400201	4017807408799		350	225510207	4017807277913	
467	212400204	4017807490510		357	229210207	4017807413304	T2292-00
467	212400207	4017807408850		357	229210231	4017807413281	T2292-00
467	212400224	4017807408867		357	229210232	4017807413298	T2292-00
467	212400232	4017807408812		166	241110131	4017807572193	T2411-00
342	212600130	4017807526288	G21261-01	166	241110132	4017807572209	T2411-00
342	212600156	4017807526561	G21261-01	172	241670132	4017807542516	T2416-00
342	212600230	4017807526318	G21262-01	64	241810205	4017807541793	T2418-00
342	212600256	4017807526578	G21262-01	62	241810208	4017807541861	T2418-00
365	212700104	4017807522129	G21271-01	268	242910180	4017807550726	T64291-00
365	212700107	4017807522112	G21271-01	364	2522011-06	4017807080797	92105
365	212700204	4017807522143	G21272-01	52	255410207	4017807415162	
365	212700207	4017807522136	G21272-01	124	271170201	4017807247251	
				124	271170202	4017807247268	92765-02

Seite Page	Artikel-Nr. Product No.	EAN-Nummer EAN-Number	Ersatzteile Spare parts	Seite Page	Artikel-Nr. Product No.	EAN-Nummer EAN-Number	Ersatzteile Spare parts
124	271170211	4017807508680	92765-11	522	283916006	4017807507904	
356	271470207	4017807374681	92940-01	522	283916032	4017807507911	
356	271470279	4017807374698	92940-02	522	283919006	4017807507928	
375	272970401	4017807284652		522	283919032	4017807507935	
375	272970487	4017807284669		526	284071206	4017807507638	
375	272970701	4017807284676		526	284071232	4017807507645	
375	272970787	4017807284683		526	284074206	4017807507676	
374	273070401	4017807284690		526	284074232	4017807507683	
374	273070701	4017807284706		526	284077906	4017807507652	
374	273071301	4017807284713		526	284077932	4017807507669	
374	273071801	4017807284720		548	284114006	4017807507591	D2841-06
372	273170301	4017807284737		548	284114032	4017807507607	D2841-32
372	273170387	4017807284744		548	284116006	4017807507614	D2841-06
372	273170401	4017807284751		548	284116032	4017807507621	D2841-32
372	273170487	4017807284768		521	284270106	4017807585278	G2842-01
371	273370307	4017807284799		521	284270132	4017807585285	G2842-01
350	274670105	4017807293968		253	300900101	4017807298673	
350	274670205	4017807293975		253	300900102	4017807298680	
418	274770132	4017807390056		211	301000367	4017807478167	G3010-52
430	279770104	4017807275346		116	301200300	4017807398649	92855
430	279770107	4017807275353		254	301300142	4017807390322	
430	279770108	4017807275360		254	301300342	4017807390346	
430	279770132	4017807542363		254	301300442	4017807390353	
544	2803021-06	4017807147599	9579-01	260	301400101	4017807195422	92270-01
544	2803031-06	4017807147605	9579	261	301700107	4017807196009	9408-01
530	281570606	4017807245967		261	301700108	4017807196016	9408-01
530	281570906	4017807245950		199	301900467	4017807502602	
518	282410106	4017807280821		112	302000308	4017807436112	G2020-01
518	282410206	4017807280838		111	302000332	4017807506389	G2020-01
532	282990106	4017807345070		111	302000342	4017807433067	G2020-54
520	283110106	4017807382846		112	302000608	4017807522778	G2020-01
520	283110132	4017807508000		110	302000632	4017807522754	G2020-01
520	283110206	4017807382853		110	302000642	4017807522761	G2020-54
520	283110232	4017807508024					G3020-54
528	283270106	4017807384048		194	302100130	4017807451252	S30211-01
528	283270132	4017807508116		194	302100430	4017807451269	S30212-01
528	283270206	4017807384055		232	302400404	4017807523355	
528	283270232	4017807508123		231	302400407	4017807523416	
528	283270306	4017807384062		231	302400431	4017807523492	
528	283270332	4017807508154		231	302400432	4017807523515	
551	283400106	4017807508246		232	302400480	4017807523454	
551	283400132	4017807508253		232	302400604	4017807523577	
550	283500106	4017807513967		231	302400607	4017807523591	
550	283500132	4017807513998		231	302400631	4017807523638	
533	283600406	4017807514018		231	302400632	4017807523652	
535	283770106	4017807508079		232	302400680	4017807523614	
535	283770132	4017807508086		117	302500301	4017807364934	
535	283779106	4017807508093		212	302900102	4017807292497	92779
535	283779132	4017807508109		188	303000132	4017807476781	
524	283811206	4017807507997		188	303090132	4017807476798	
524	283811232	4017807507980		141	303100417	4017807567779	S3026-44
524	283814206	4017807507959	T28381-00				S3026-11
524	283814232	4017807507942	T28381-01				S3026-26
524	283817906	4017807507966	T28382-00				S3026-01
524	283817932	4017807507973	T28382-00				

INDEX · NUMERIC

Seite Page	Artikel-Nr. Product No.	EAN-Nummer EAN-Number	Ersatzteile Spare parts	Seite Page	Artikel-Nr. Product No.	EAN-Nummer EAN-Number	Ersatzteile Spare parts
200	303400167	4017807425376		108	310630354	4017807507492	G0106-54
200	303400367	4017807425383		246	310800108	4017807503845	
91	303500331	4017807422061	C3035-01	246	310800308	4017807503852	
91	303500332	4017807422078	C3035-01	246	310890108	4017807503838	S31082-08
256	303700104	4017807286601		150	311100308	4017807537826	
256	303700162	4017807286625		150	311100367	4017807537703	
252	304100100	4017807247411		101	311210506	4017807367768	92829-40
252	304100106	4017807247404	92634-06				92833-10
208	304300132	4017807467499					92833-12
208	304300432	4017807467567					92833-14
209	304330332	4017807467512		100	311210606	4017807367775	92829-50
115	304400201	4017807364989	92830-040				92833-10
139	305400401	4017807336948	93782				92833-12
139	305400411	4017807336955	93782-11				92833-14
139	305400441	4017807391022	93782-41	130	311400132	4017807538526	
139	305400479	4017807336962	93782-79	130	311400432	4017807538410	
183	305500467	4017807441093		147	311900632	4017807536607	
213	305900126	4017807330816		147	311900732	4017807537949	
213	305900130	4017807330809		186	312200136	4017807544817	
152	306700602	4017807373912		114	312200200	4017807522006	G3122-52
152	306700632	4017807364392		186	312200336	4017807544800	
153	306700732	4017807399905		184	312300136	4017807504620	S3123-36
104	307601206	4017807426861	G50761-54	230	312400101	4017807408713	
244	308000132	4017807288827		230	312400107	4017807408737	
137	308200179	4017807392517		230	312400132	4017807408720	
118	308300307	4017807510638	92980-01 92983-07	230	312400401	4017807408751	
120	308300308	4017807510645	92980-01 92983-08	230	312400407	4017807408775	
106	308500542	4017807468601	G40342-54	230	312400432	4017807408768	
106	308590342	4017807468625	G40342-54	233	312490407	4017807523676	
242	308600706	4017807378306	B3086-00 P3086-06	233	312490431	4017807523690	
245	309300302	4017807354102	92836-04 92836-05 92836-06 92836-07	233	312490432	4017807523720	
92	309800431	4017807387681	92887	233	312490607	4017807523744	
92	309800432	4017807387698	92887	233	312490631	4017807523805	
98	309900631	4017807330946		233	312490632	4017807523843	
98	309900632	4017807330953	92943	206	312700132	4017807502725	
99	309900657	4017807573657	G3099-57	206	312700432	4017807502718	
212	310100104	4017807408607		238	313100531	4017807538496	G3131-01
212	310100204	4017807408591		238	313100532	4017807538519	G3131-02
257	310100562	4017807356045		238	313100931	4017807538489	G3131-01
236	310300132	4017807532951	G3103-54	238	313100932	4017807538472	G3131-02
236	310300532	4017807522471	G3103-54	251	313300432	4017807503692	
236	310390332	4017807522488	G3103-54	204	313800332	4017807502855	
247	310500332	4017807566826		204	313800532	4017807502862	
247	310500632	4017807566864		250	313900132	4017807505061	S3139-32 G3139-01
108	310600132	4017807427264	G0106-54	178	314300430	4017807538915	
108	310600154	4017807507478	G0106-54	105	315190132	4017807539646	G3151-57
108	310600432	4017807427288	G0106-54	241	315200179	4017807287998	
108	310600454	4017807507515	G0106-54	190	315900132	4017807540246	
108	310630332	4017807435696	G0106-54	190	315900142	4017807540277	
				102	317000332	4017807542271	G31701-57 G31702-57 G31703-57

Seite Page	Artikel-Nr. Product No.	EAN-Nummer EAN-Number	Ersatzteile Spare parts	Seite Page	Artikel-Nr. Product No.	EAN-Nummer EAN-Number	Ersatzteile Spare parts
102	317000632	4017807542295	G31701-57 G31702-57 G31703-57	88	340910331	4017807537994	T34092-00
102	317000832	4017807542301	G31701-57 G31702-57 G31703-57	89	340910332	4017807538106	T34092-00
142	319000344	4017807574135		74	341210305	4017807540161	T3412-00
144	319400417	4017807574593		74	341210308	4017807540086	T3412-00
144	319400617	4017807574623		173	341610132	4017807542455	T3416-00
144	319430317	4017807574609		65	341810205	4017807540710	T3418-00
324	319500207	4017807574654	G3195-01	63	341810208	4017807540734	T3418-00
324	319500232	4017807574630	G3195-54	94	342010107	4017807542066	G3420-01 T3420-00
324	319500307	4017807574661	G3195-01	94	342010108	4017807542080	G3420-01 T3420-00
324	319500332	4017807574647	G3195-54	97	342010132	4017807542073	G3420-57 T3420-00
76	320310307	4017807487909	T3203-00	94	342010207	4017807542097	G3420-01 T34202-00
76	320310308	4017807487916	T3203-00	94	342010208	4017807542134	G3420-01 T34202-00
76	320310331	4017807487930	T3203-00	97	342010232	4017807542127	G3420-57 T34202-00
76	320310332	4017807487923	T3203-00	94	342010307	4017807542141	G3420-01 T34203-00
72	321210107	4017807454000	T3212-00	94	342010308	4017807542158	G3420-01 T34203-00
72	321210108	4017807461145	T3212-00	97	342010332	4017807542172	G3420-57 T34203-00
226	321611131	4017807468724	T3216-00 92957	225	342710205	4017807542318	T3427-00
226	321611132	4017807468731	T3216-00	225	342710208	4017807542233	T3427-00
226	321691131	4017807468748	T3216-00	217	343310305	4017807577822	T3433-00
226	321691132	4017807468755	T3216-00	217	343310332	4017807577839	T3433-00
81	321710107	4017807430486	T3217-01 T3217-00	217	343310365	4017807577815	T3433-00
81	321710142	4017807430493	T3217-01 T3217-00	222	343610307	4017807577570	T3436-00 G3436-01
229	321910307	4017807453584	T3219-00	222	343610308	4017807579673	T3436-00 G3436-01
229	321910342	4017807453607	T3219-00	60	344110105	4017807577907	T3441-00
86	322610431	4017807424294		60	344110165	4017807577860	T3441-00
86	322610432	4017807424300		60	344110180	4017807579833	T3441-00
164	322910532	4017807524963	T3229-00	260	3490400-00	4017807062465	
180	323710130	4017807451191		49	352710307	4017807453775	T3527-00 92873IR
82	325010105	4017807422627	T3250-00	49	352710342	4017807473308	T3527-00 92873IR
82	325010132	4017807422634	T3250-00	47	353810305	4017807574784	T6538-00 92873IR
228	325110131	4017807467758	T3251-00	260	3590010-01	4017807062496	
70	326210107	4017807505221		258	371010307	4017807281750	92734-01
70	326210132	4017807505214		258	371010308	4017807281767	92734-01
66	326510107	4017807510034	T3260-00	258	371010407	4017807281781	92734-01
66	326510108	4017807510041	T3260-00	258	371010408	4017807281798	92734-01
66	326510142	4017807510058	T3260-00	80	371310105	4017807445336	
66	326510207	4017807510065	T32602-00	80	371310131	4017807451801	
66	326510208	4017807510072	T32602-00	80	371310142	4017807445343	
66	326510242	4017807510089	T32602-00	259	3751031-07	4017807137729	9350
67	326510307	4017807510096	T32603-00	259	3751041-07	4017807137736	9350
67	326510308	4017807510102	T32603-00	259	3751051-07	4017807169027	9350
67	326510342	4017807510119					
175	326610232	4017807505474					
78	326810132	4017807506518	T3268-00				
224	327210305	4017807504200	T3272-00				
224	327210332	4017807504194	T3272-00				
88	340910131	4017807537956	T34091-00				
89	340910132	4017807537970	T34091-00				

INDEX · NUMERIC

Seite Page	Artikel-Nr. Product No.	EAN-Nummer EAN-Number	Ersatzteile Spare parts	Seite Page	Artikel-Nr. Product No.	EAN-Nummer EAN-Number	Ersatzteile Spare parts
218	375310502	4017807504446	T3753-00	118	408300307	4017807510676	92981-07
218	375310505	4017807504439	T3753-00	120	408300308	4017807510683	92981-08
218	375310507	4017807472226	T3753-00	106	408500542	4017807468670	G40342-54
218	375310508	4017807481839	T3753-00	423	408800332	4017807390148	
218	375310532	4017807472233	T3753-00	123	409100307	4017807389654	
221	375510407	4017807469844	T3755-00	123	409100308	4017807389661	
221	375510432	4017807469882	T3755-00	101	411210406	4017807367836	92829-40
220	379190707	4017807362831					92833-10
220	379190732	4017807471229					92833-12
389	400200107	4017807368390	92820-01				92833-14
389	400200108	4017807378320	92820-01	134	411400132	4017807538618	
388	400400107	4017807423211	S4004-11	134	411400232	4017807538731	
388	400400132	4017807423228	S4004-11	130	411490132	4017807538687	
158	401000224	4017807504712	G4010-01	397	411700107	4017807575231	S4117-07
124	401100101	4017807276121	92782-01				F4117-32
124	401100102	4017807276138	92782-02	397	411700108	4017807522501	S4117-08
124	401100111	4017807505580	S4011-11				F4117-32
192	401200101	4017807502640	S3012-01	475	411900231	4017807523041	
380	401700317	4017807502541	S4017-01	147	411900232	4017807523058	
			S4017-02	184	412300136	4017807561302	S3123-36
			S4017-11	424	412400107	4017807488777	
			F4017-02	424	412400108	4017807488760	
198	401900367	4017807502619		424	412400131	4017807488784	
112	402000108	4017807436099	G4020-01	424	412400132	4017807488791	
111	402000132	4017807506426	G4020-01	206	412700132	4017807502732	
111	402000142	4017807433012	G4020-54	178	414300530	4017807538861	
205	402690167	4017807502688		382	414400107	4017807539448	S4144-01
188	403000132	4017807468076		382	414400108	4017807539455	S4144-01
140	403100317	4017807567786	S5031-44	382	414400132	4017807539486	S4144-01
			S4031-11	384	415700307	4017807539929	S4157-01
			S4031-26	384	415700332	4017807539950	S4157-01
202	403400167	4017807426854		387	416900207	4017807541724	S41691-07
394	403400317	4017807422986	G40341-13				S41692-07
			G40342-19	387	416900208	4017807541717	S41691-08
			G40343-54				S41692-08
394	403400354	4017807422948	G40341-54	102	417000332	4017807581201	G31701-57
			G40342-54				G31702-57
			G40343-54				G31703-57
427	4035011-04	4017807090604	92174	142	419090144	4017807574159	
427	4035011-07	4017807090611	92174	378	419200131	4017807574531	S4192-11
427	4035011-08	4017807090628	92174				F4192-31
129	403900201	4017807433654	S40391-01	378	419200141	4017807574524	S4192-41
			S40392-01				F4192-32
129	403900208	4017807494556	S40391-81	396	4200011-06	4017807105650	913244
			S40392-81	421	420490107	4017807295337	9243-01
129	403900211	4017807433661	S40391-11	421	420490132	4017807382525	9243-01
			S40392-11	413	420810107	4017807367614	
209	404300332	4017807467727		412	420910107	4017807367591	
422	404600332	4017807377361		412	420910108	4017807367607	
183	405500367	4017807466751		73	421210107	4017807454024	T4212-01
152	406700632	4017807364415		73	421210108	4017807461169	T4212-01
393	407800132	4017807303216		411	421910207	4017807267532	92685
154	408000132	4017807407303					92685-01
136	408200179	4017807392593					92754-01
137	408290179	4017807392616					

Seite Page	Artikel-Nr. Product No.	EAN-Nummer EAN-Number	Ersatzteile Spare parts	Seite Page	Artikel-Nr. Product No.	EAN-Nummer EAN-Number	Ersatzteile Spare parts
411	421910228	4017807267549	92685 92685-01 92754-01	74	441210308	4017807540390	T4412-00
87	422610531	4017807423822	T4226-00 T4226-0 T4226-01 T4226-02	173	441610132	4017807542530	T4416-00
87	422610532	4017807423853	T4226-00 T4226-0 T4226-01 T4226-02	65	441810205	4017807540765	T4418-00
401	422710307	4017807343076		63	441810208	4017807541731	T4418-00
401	422710308	4017807354270		158	4602021-24	4017807196801	92274 92274-01
414	423310107	4017807505825		124	461100101	4017807247220	92597-01
414	423310108	4017807506105		124	461100102	4017807247237	92597-02
414	423310131	4017807588668		124	461100111	4017807508673	92597-11
414	423310132	4017807506099		381	462100132	4017807398922	S4621-02
85	423410107	4017807506297	T4234-00	416	470310104	4017807523348	
85	423410131	4017807506310	T4234-00	416	470310131	4017807523324	
85	423410132	4017807506327	T4234-00	416	470310132	4017807523331	
406	424210304	4017807467635	T4242-00	83	472910106	4017807299281	
406	424210307	4017807467628	T4242-00	459	473190307	4017807302691	
406	424210332	4017807467598	T4242-00	459	473190332	4017807382532	
404	424310204	4017807525199	T4243-00	392	474410179	4017807359633	
404	424310207	4017807525182	T4243-00	418	474790132	4017807390094	
404	424310208	4017807525205	T4243-00	390	475310307	4017807380439	
404	424310232	4017807525212	T4243-00	390	475310379	4017807380446	92844-79
426	424810107	4017807257687	98249	407	478310206	4017807336795	T4783-00
426	424810207	4017807257700	98249	389	500200107	4017807368406	
409	424910207	4017807353938	92928	389	500200108	4017807378313	
402	425610204	4017807525243	T4243-00	161	500700128	4017807354201	92809
402	425610207	4017807525229	T4243-00 T42561-00	158	501000224	4017807504729	G5010-01
402	425610208	4017807525250	T4243-00 T42561-00	128	501100101	4017807246810	
402	425610232	4017807525267	T4243-00 T42561-00	128	501100102	4017807246827	
71	426219107	4017807505276		112	502000108	4017807436075	G2020-01
71	426219132	4017807505269		110	502000132	4017807506402	G2020-01
174	426410130	4017807505450	T4264-00	110	502000142	4017807432992	G2020-54
410	426410207	4017807244717		194	502100130	4017807473476	S30212-01
410	426410208	4017807244724	92730	448	5027011-01	4017807017366	
66	426510104	4017807525342	T42652-00	448	5027011-17	4017807051360	
66	426510107	4017807525335	T42652-00	448	5027011-47	4017807124941	
66	426510108	4017807525359	T42652-00	446	5028010-01	4017807051414	
66	426510142	4017807525366	T42652-00	446	5028010-02	4017807051421	
68	426510204	4017807525281	T42651-00	446	5028010-17	4017807051438	
68	426510207	4017807525274	T42651-00	446	5028010-47	4017807051445	
68	426510208	4017807525298	T42651-00	449	5029010-01	4017807051377	
68	426510242	4017807525311	T42651-00	449	5029010-47	4017807051407	
398	426511832	4017807467390	T4265-02	141	503100144	4017807567793	S5031-44
78	426810132	4017807506501	T42681-00	209	504300132	4017807467703	
399	427511801	4017807274332	92777	445	504900104	4017807522570	
399	427511802	4017807274349	92777	445	504900107	4017807522556	
74	441210305	4017807540413	T4412-00	445	504900131	4017807522518	
				445	504900132	4017807522532	
				428	505200112	4017807568790	
				428	505200149	4017807568745	
				428	505200177	4017807568776	
				428	505200183	4017807568684	
				429	506200131	4017807560831	
				429	506200132	4017807560824	
				429	506290131	4017807560879	
				429	506290132	4017807560848	
				154	508000132	4017807407280	

INDEX · NUMERIC

Seite Page	Artikel-Nr. Product No.	EAN-Nummer EAN-Number	Ersatzteile Spare parts	Seite Page	Artikel-Nr. Product No.	EAN-Nummer EAN-Number	Ersatzteile Spare parts
136	508200179	4017807392555	92999	447	527290102	4017807291445	
444	508300131	4017807422313		435	527590107	4017807371758	92825
444	508300132	4017807422337		435	527590179	4017807373103	92825
122	509100107	4017807398540	S5091-01	443	527690131	4017807372304	
122	509100108	4017807398557	S5091-01	443	527690132	4017807372311	
108	510600132	4017807427240	G0106-54	440	527920101	4017807276046	
108	510600154	4017807507522	G0106-54	440	527920102	4017807276053	
128	511100101	4017807246841	S511100101	434	529690100	4017807262032	92671-00
128	511100102	4017807246858	92807-02	434	529690107	4017807262070	92671-07
100	511210306	4017807367829	92829-28 92833-10 92833-12	433	529990103	4017807248340	92584
130	511400132	4017807538755		433	529990107	4017807248364	92584
475	511900131	4017807523072		74	541210205	4017807540284	T5412-00
147	511900132	4017807523089		74	541210208	4017807540253	T5412-00
186	512200136	4017807544831		173	541610132	4017807542493	T5416-00
424	512400107	4017807488746		65	541810205	4017807541748	T5418-00
424	512400108	4017807488753		63	541810208	4017807541762	T5418-00
424	512400131	4017807488722		95	542010107	4017807561395	G3420-01 T3420-01
424	512400132	4017807488739		95	542010108	4017807561418	G3420-01 T3420-01
178	514300230	4017807538885		96	542010132	4017807561456	G3420-57 T3420-01
382	514400107	4017807539301	S5144-01	96	542010134	4017807561401	G3420-01 T3420-01
382	514400108	4017807539370	S5144-01	416	570310104	4017807523294	
382	514400132	4017807539400	S5144-01	416	570310131	4017807523256	
105	515190132	4017807539707	G5151-57	416	570310132	4017807523270	
384	515700107	4017807539882	S5157-01	83	572910106	4017807303162	
384	515700132	4017807539905	S5157-01	459	573190107	4017807302677	
384	515790107	4017807554977	S51571-01	459	573190131	4017807302684	
384	515790132	4017807554991	S51571-01	392	574410179	4017807359626	
142	519000144	4017807574142		390	575310307	4017807380453	
412	520910107	4017807367577	T5209-00	390	575310379	4017807380460	
412	520910108	4017807367584	T5209-00	430	579790104	4017807275285	T5797-00
73	521210107	4017807454017	T5212-00	430	579790107	4017807275322	T5797-00
73	521210108	4017807461152	T5212-00	430	579790108	4017807275339	T5797-00
442	522520187	4017807226782		430	579790132	4017807452549	
87	522610331	4017807423792		437	590100107	4017807551129	9424
87	522610332	4017807423815		437	590100132	4017807551136	9424
441	523090131	4017807502503		436	590200107	4017807551143	9426
441	523090132	4017807502527		436	590200132	4017807551150	9426
414	523310107	4017807505771		436	591000107	4017807551167	9262-01
414	523310108	4017807505818		436	591000132	4017807551174	9262-01
414	523310131	4017807588675		432	592300107	4017807551211	9309
414	523310132	4017807505801		138	595400101	4017807337778	93781
434	525490106	4017807371710	92826	138	595400111	4017807337785	93781-11
434	525490107	4017807371727	92826	138	595400179	4017807337792	
432	525790107	4017807385663	92876	438	595700106	4017807551273	9610-01
432	525790108	4017807385670	92876	438	595700107	4017807551280	9610-00
68	526510104	4017807525373	T5265-00	438	595700108	4017807551297	9610-00
68	526510107	4017807510140	T5265-00	439	599100106	4017807551303	92271-06
68	526510108	4017807510157	T5265-00	439	599100107	4017807551310	92271-07
68	526510142	4017807510164	T5265-00	439	599100108	4017807551327	92271-07
78	526810132	4017807506471	T52681-00	439	599100118	4017807551334	92271-18
446	527090111	4017807372328		439	599100124	4017807551341	92271-07
446	527090131	4017807372335					
447	527290101	4017807291438					

Seite Page	Artikel-Nr. Product No.	EAN-Nummer EAN-Number	Ersatzteile Spare parts	Seite Page	Artikel-Nr. Product No.	EAN-Nummer EAN-Number	Ersatzteile Spare parts
438	599700101	4017807551358	92934-01	92	609800432	4017807387711	92887
438	599700115	4017807551365		98	609900331	4017807330960	92943-01
438	599700119	4017807551372		98	609900332	4017807330984	92943
438	599700142	4017807551389		99	609900357	4017807573671	G3099-57
160	600700328	4017807354225	92809	344	6101011-01	4017807017557	9218-01
156	601000324	4017807504699	G1010-01	344	6101011-07	4017807028393	9218-01
116	601200100	4017807398601	92851	158	6102021-24	4017807053296	92126
116	601200200	4017807398618	92852	345	6105011-01	4017807053968	9285-01
198	601900467	4017807502596		345	6105021-01	4017807098440	9287-01
194	602100130	4017807491500	S30211-01 C30211-01	150	611100308	4017807537789	
117	602500101	4017807364941	92831-30	150	611100367	4017807537642	
117	602500201	4017807364958	92831-40	100	611210506	4017807367782	92829-40 92833-10 92833-12 92833-14
140	603100244	4017807567748	S60261-44 C60261-01	132	611400332	4017807538700	
140	603100344	4017807567755	S60262-44 C60262-01	134	611400532	4017807544572	
140	603130317	4017807573817	S6026-44 S60264-11 S60265-26	134	611490332	4017807544565	
366	603300101	4017807433784		196	611500201	4017807526158	S61152-01
90	603500331	4017807422047	C6035-01	196	611500202	4017807526165	S61152-02
90	603500332	4017807422054	C6035-01	196	611500301	4017807526202	S61153-01
126	603900301	4017807256536	92662	196	611500302	4017807526219	S61153-02
126	603900302	4017807256543	92662-02	148	611900632	4017807536584	
126	603900311	4017807505627	S60392-11	114	612200100	4017807522037	G61221-52
126	603900501	4017807369298	92631-65	114	612200200	4017807522051	G61222-52
126	603900502	4017807369304	92631-65	186	612200336	4017807544824	
126	603900511	4017807505634	S60393-11 92631-65	184	612300236	4017807504637	S6123-36
115	604400101	4017807364996	92830-30	467	612400501	4017807411614	
115	604400201	4017807365009	92830-40	467	612400504	4017807490619	
334	604900331	4017807454284		467	612400507	4017807411638	
334	604900332	4017807454307		467	612400532	4017807411621	
334	604900631	4017807454345		464	612400580	4017807523980	
334	604900632	4017807454369		342	612600230	4017807526325	G6126-01
138	605400501	4017807349214	93781	342	612600256	4017807526585	G6126-01
138	605400511	4017807349221	93781-11	337	612900131	4017807426441	
138	605400579	4017807349238	93781-79	337	612900132	4017807426465	
182	605500467	4017807442588		337	612900134	4017807558876	
152	606700632	4017807373448		337	612900180	4017807558890	
341	606900132	4017807504170		337	612900231	4017807426526	
341	606900161	4017807351781		337	612900232	4017807426533	
341	606900162	4017807356823		337	612900431	4017807426588	
341	606903032	4017807512069		337	612900432	4017807426595	
341	606905032	4017807512038		339	613000131	4017807426908	
104	607601206	4017807426885	G50761-54	339	613000132	4017807426915	
340	608100224	4017807211795	92472-01	339	613000134	4017807558913	
340	608100324	4017807211788	92472	339	613000180	4017807558937	
136	608200279	4017807392531		339	613000231	4017807426922	
118	608300307	4017807510652	92980-01 92985-07	339	613000232	4017807426939	
120	608300308	4017807510669	92980-01 92985-08	339	613000431	4017807426977	
92	609800431	4017807387704	92887	339	613000432	4017807426984	
				178	614300430	4017807538939	
				105	615190132	4017807539660	G5151-57
				190	615900232	4017807540321	
				190	615900242	4017807540338	

INDEX · NUMERIC

Seite Page	Artikel-Nr. Product No.	EAN-Nummer EAN-Number	Ersatzteile Spare parts	Seite Page	Artikel-Nr. Product No.	EAN-Nummer EAN-Number	Ersatzteile Spare parts
293	616700306	4017807541687	G61671-57 B61671-00	86	622610431	4017807424270	T6226-04
293	616700506	4017807541700	G61672-57 B61672-00	86	622610432	4017807424287	T6226-04
142	619000244	4017807574128		86	622610531	4017807488821	T6226-00
144	619430317	4017807574616		86	622610532	4017807488838	T6226-00
344	6196011-01	4017807138238	9523-01	164	622910332	4017807524994	T6229-00
344	6196011-07	4017807138245	9523-07	164	622910532	4017807524987	T3229-00
278	620010407	4017807449525	F6200-01 F6200-00	85	623410207	4017807506235	92969RD T62341-00
278	620010408	4017807550788	F6200-00 F6200-01	85	623410231	4017807506242	92969RD T62341-00
278	620010431	4017807452204	F6200-00 F6200-01	85	623410232	4017807506259	92969RD T62341-00
278	620010442	4017807449495	F6200-01	85	623419207	4017807506266	92969RD T62342-00
76	620310307	4017807487862	T6203-00	85	623419231	4017807506273	92969RD T62342-00
76	620310308	4017807487893	T6203-00	85	623419232	4017807506280	92969RD T62342-00
76	620310331	4017807487879	T6203-00	180		4017807451184	
76	620310332	4017807487886	T6203-00	355	624110279	4017807337051	92795
284	620510307	4017807488586	D62051-52 F6205-00 T6205-00	82	625010105	4017807422641	T6250-00
284	620510331	4017807488579	D62051-52 F6205-00 T6205-00	304	625815031	4017807506457	92970RD
284	620510332	4017807488562	D62051-52 F6205-00 T6205-00	70	626210107	4017807505191	
				70	626210132	4017807505184	
				174	626410530	4017807505429	92967RD 929671RD T6264-01
276	620710330	4017807562439	93790RD	68	626510304	4017807538144	T6265-00
276	620710331	4017807562415	93790RD	68	626510307	4017807538083	T6265-00
276	620710332	4017807562392	93790RD	68	626510308	4017807538120	T6265-00
276	620710380	4017807562453	93790RD	68	626510342	4017807538168	T6265-00
72	621210107	4017807453980	T62121-00	332	626510987	4017807245202	
72	621210108	4017807461121	T62121-00	332	626511287	4017807245226	
72	621290107	4017807453997	T62122-00	332	626512587	4017807246803	
72	621290108	4017807461138	T62122-00	175	626610232	4017807505498	
457	621410505	4017807220940	92426	323	626910307	4017807506587	92996RD BATCN00020
81	621710107	4017807430509	T6217-00	323	626910332	4017807506594	92996RD BATCN00020
81	621710142	4017807430516	T6217-00	323	626919307	4017807506600	92996RD BATCN00020
320	621910317	4017807504019	S6219-01 S6219-02 S6219-11	323	626919332	4017807506617	92996RD BATCN00020
320	621911201	4017807337105	F6205-00	309	627413031	4017807525007	T62741-00
320	621911211	4017807337112	F6205-00	309	627413032	4017807525014	T62741-00
320	621912401	4017807337143	F6205-00	309	627413087	4017807525021	T62741-00
320	621912411	4017807337150	F6205-00	309	627415031	4017807525038	T62742-00
321	621914001	4017807384468	92883IR F6205-00	309	627415032	4017807525069	T62742-00
321	621914011	4017807384475	92883IR F6205-00	309	627415087	4017807525076	T62742-00
321	621915501	4017807384482	F6205-00 92883IR T62193-00	309	627417531	4017807525083	T62743-00
321	621915511	4017807384499	F6205-00 92883IR T62193-00	309	627417532	4017807525090	T62743-00
				309	627417587	4017807525106	T62743-00
				330	627514000	4017807401837	6289IR-2 T62751-00

Seite Page	Artikel-Nr. Product No.	EAN-Nummer EAN-Number	Ersatzteile Spare parts	Seite Page	Artikel-Nr. Product No.	EAN-Nummer EAN-Number	Ersatzteile Spare parts
330	627516000	4017807401820	6289IR-2 T62752-00 BATCN00020	273	643010365	4017807574753	T6430-00 93799RD
282	627710432	4017807442182		168	643210332	4017807577075	T64321-00
282	627710532	4017807448184	T62772-01	168	643210432	4017807577082	T64322-00
303	628410507	4017807504071	92975RD T6284-00	170	643810232	4017807588446	
303	628410532	4017807504040	92975RD T6284-00	170	643810287	4017807588453	
328	628513001	4017807298819		170	643810332	4017807588415	TH36591-00
328	628613001	4017807298826		170	643810387	4017807588439	TH36591-00
327	628915001	4017807272307	6289IR-2	170	643810432	4017807577051	T6438-00
306	629210331	4017807525113	T6292-00 93000RD	170	643810487	4017807577068	T6438-00
306	629219331	4017807525120	T62921-00 93000RD	60	644110105	4017807577914	T6441-00
88	640910131	4017807537901	T6409-00	60	644110165	4017807577877	T6441-00
89	640910132	4017807537925	T6409-00	60	644110180	4017807579840	T6441-00
166	641110231	4017807572131	T64111-00	265	644810107	4017807580952	T6448-00
166	641110232	4017807572148	T64111-00	265	644810132	4017807580945	T6448-00
166	641110331	4017807572155	T64112-00	305	647110131	4017807575293	T6471-00 93804RD
166	641110332	4017807572162	T64112-00	514	650000106	4017807376210	
74	641210305	4017807539936	T6412-00	514	650000107	4017807376234	
74	641210308	4017807539912	T6412-00	514	650000108	4017807376241	
310	641310208	4017807575019	T6413-00	514	650000131	4017807376203	
310	641310231	4017807574999	T6413-00	514	650000132	4017807378061	
310	641310232	4017807575002	T6413-00	514	650000306	4017807376258	
310	641310265	4017807575026	T6413-00	514	650000307	4017807376265	
294	641412106	4017807539288	G6414-57 T6414-00	514	650000331	4017807376272	
294	641412107	4017807539226	G6414-01 T6414-00	514	650100106	4017807376302	
294	641412132	4017807539257	G64141-01 T6414-00	514	650100107	4017807376319	
312	641510207	4017807574395	93801IR	514	650100108	4017807376326	
312	641510280	4017807574401	93801IR	514	650100131	4017807376296	
312	641519207	4017807574418	93801IR	514	650100132	4017807378078	
312	641519280	4017807574425	93801IR	515	650100306	4017807376333	
172	641610232	4017807542431	T6416-00	515	650100307	4017807376340	
64	641810205	4017807540741	T6418-00	515	650100331	4017807376357	
62	641810208	4017807540758	T6418-00	511	650210106	4017807376388	
266	641910205	4017807541939	T6419-00	511	650210107	4017807376395	
266	641910208	4017807541953	T6419-00	511	650210131	4017807376371	
274	642110331	4017807541830	T6421-00	511	650310106	4017807376463	
274	642110332	4017807541816	T6421-00	511	650310107	4017807376470	
274	642110431	4017807541908	T64212-00	511	650310131	4017807376456	
274	642110432	4017807541885	T64212-00	509	650410106	4017807376630	
268	642910280	4017807542974	T64292-00	509	650410107	4017807376647	
268	642910380	4017807542998	T64293-00	509	650410131	4017807376623	
273	643010306	4017807574739	T6430-00 93799RD	509	650410132	4017807378030	
273	643010307	4017807574760	T6430-00 93799RD	509	650510106	4017807376753	
273	643010332	4017807574746	T6430-00 93799RD	509	650510107	4017807376760	
				509	650510131	4017807376722	
				509	650510132	4017807378085	
				508	650610106	4017807376869	
				508	650610107	4017807376876	
				508	650610131	4017807376890	
				508	650610132	4017807442595	
				508	650710106	4017807376937	
				508	650710107	4017807376944	
				508	650710131	4017807376951	
				508	650710132	4017807442601	

INDEX · NUMERIC

Seite Page	Artikel-Nr. Product No.	EAN-Nummer EAN-Number	Ersatzteile Spare parts	Seite Page	Artikel-Nr. Product No.	EAN-Nummer EAN-Number	Ersatzteile Spare parts
455	651000107	4017807573947		507	653610132	4017807574500	93800IR
455	651000131	4017807573923		507	653610306	4017807574470	93800IR
455	651000132	4017807573930		507	653610331	4017807574494	93800IR
455	651000207	4017807573978		507	653610332	4017807574517	93800IR
455	651000231	4017807573954		46	653810305	4017807574777	T6538-00 92873IR
455	651000232	4017807573961		56	656010100	4017807389845	
455	651000307	4017807574005		56	656090100	4017807389869	
455	651000331	4017807573985		333	656411506	4017807371796	
455	651000332	4017807573992		333	656412406	4017807371802	
53	651210507	4017807389753		333	656511806	4017807371826	
512	651500131	4017807455915		333	656512006	4017807371833	
512	651500132	4017807455939		54	657411107	4017807436358	
512	651600131	4017807455946		54	657414007	4017807434521	T65741-20
512	651600132	4017807455977		54	657416007	4017807434552	T65741-36 92873IR
512	651600231	4017807456011		547	659011801	4017807280081	
512	651600232	4017807455991		547	659011806	4017807508413	
510	651700152	4017807425888		547	659011832	4017807508406	
510	651800152	4017807425901		547	659011887	4017807280098	
57	651914001	4017807389609		540	659411806	4017807280050	
57	651915501	4017807389616		540	659412406	4017807280074	
510	652100152	4017807425925		290	670710507	4017807503470	92975RD T6707-00
510	652200152	4017807425949		290	670710532	4017807503456	92975RD T6707-00
504	652310106	4017807427660		291	670810607	4017807503531	92975RD T6708-00
504	652310131	4017807427677		291	670810632	4017807503524	92975RD T6708-00
504	652310132	4017807504095		314	671210131	4017807489835	T67121-00
504	652410106	4017807427684		314	671210132	4017807489842	T67121-00
504	652410131	4017807427691		315	671290131	4017807489859	92960RD T67122-00
504	652410132	4017807504101		315	671290132	4017807489866	92960RD T67122-00
505	652510106	4017807427707		80	671310105	4017807445329	
505	652510131	4017807427714		80	671310131	4017807451832	
505	652510132	4017807504132		80	671310142	4017807445312	
505	652610106	4017807427721		298	671610307	4017807391237	
505	652610131	4017807427738		298	671610331	4017807391244	
505	652610132	4017807504156		283	672110505	4017807503982	T6721-00
50	652610307	4017807453881	T65261-00 92873IR	283	672110542	4017807503951	T6721-00
50	652610342	4017807453751	T65261-00 92873IR	285	672310207	4017807503371	92966RD T6723-00
51	652690307	4017807453898	T65269-00	285	672310232	4017807503357	92966RD T6723-00
51	652690342	4017807453768	T65269-00	281	672610332	4017807441208	
48	652710307	4017807453799	T6527-00 92873IR	83	672910106	4017807299274	T6729-00
48	652710342	4017807473339	T6527-00 92873IR	280	673210306	4017807388411	
452	652910131	4017807473643		280	673210332	4017807441192	
452	652910132	4017807473650		297	673311306	4017807358407	F6200-01
452	652910231	4017807473667		270	673810206	4017807433333	
452	652910232	4017807473674		270	673810232	4017807433364	
452	652910331	4017807473681		271	673810306	4017807505689	
452	652910332	4017807473698					
506	653410106	4017807574432					
506	653410131	4017807574449					
506	653410132	4017807574456					
507	653610106	4017807574463	93800IR				
507	653610131	4017807574487	93800IR				

Seite Page	Artikel-Nr. Product No.	EAN-Nummer EAN-Number	Ersatzteile Spare parts	Seite Page	Artikel-Nr. Product No.	EAN-Nummer EAN-Number	Ersatzteile Spare parts
271	673810332	4017807505702		324	678711206	4017807337716	
270	673890206	4017807433371		324	678713006	4017807337723	6787IR 6289IR-2
270	673890232	4017807433388		331	679210106	4017807440348	6289IR-2
286	673916007	4017807452594	T6739-00	296	679511532	4017807450767	T6795-00
286	673916031	4017807452235	T6739-00	545	6801011-01	4017807259056	
286	673916032	4017807441437	T6739-00	545	6801011-06	4017807147575	9580
286	673918007	4017807452617	T67391-00	545	6801011-07	4017807147582	9580
286	673918031	4017807452259	T67391-00	545	6801011-32	4017807507690	
286	673918032	4017807441468	T67391-00	543	680213500	4017807508475	92930-35 92974IR
319	674011207	4017807363708		543	680214800	4017807508482	92930-48 92974IR
317	674011232	4017807556315		541	680310106	4017807508437	
318	674013007	4017807363630		541	680310132	4017807508444	
316	674013032	4017807556322		541	680319106	4017807508451	
319	674014507	4017807363654		541	680319132	4017807508468	
317	674014532	4017807556339		546	680710106	4017807507843	
319	674016207	4017807363692		546	680710131	4017807507867	
317	674016232	4017807556346		546	680710132	4017807507881	
318	674093007	4017807363623		534	680810306	4017807508505	T68081-00
316	674093032	4017807556353		534	680810332	4017807508512	T68081-00
318	674094507	4017807363647		534	680819306	4017807508529	T68082-00
316	674094532	4017807556360		534	680819332	4017807508536	T68082-00
318	674096207	4017807363685		518	682410506	4017807280845	
316	674096232	4017807556377		542	686014000	4017807507744	E6260-00 T6860-00
299	674410331	4017807477108	T6744-00	542	686014001	4017807507720	E6260-00 T6860-00
300	674610507	4017807385786	T67465-00	539	686412406	4017807507805	
300	674610532	4017807575118	T67465-00	539	686512406	4017807507829	
301	674610707	4017807450224	T67467-00	538	689214032	4017807507768	
325	675610106	4017807363302	92870RD 6289IR-2 92863-241 T6756-00	538	689314032	4017807507782	
288	676210307	4017807371918		127	693900417	4017807409451	S693915-11 S693920-02 S693925-01 S693930-01
288	676210342	4017807425703		127	693900517	4017807399547	S693920-11 S693925-02 S693930-02 S693935-01
288	676210407	4017807425734		484	700131	4017807470161	
288	676210442	4017807425758		484	700132	4017807470178	
289	676240331	4017807524901	T67623-00	484	700187	4017807470246	
289	676240431	4017807524949	T67624-00	484	700231	4017807470277	
322	676611031	4017807398533	93787RD T67663-00 92868RD BATCN00020	484	700232	4017807470307	
322	676615031	4017807398519	93787RD 92868RD BATCN00020 CAP01F250	484	700287	4017807470253	
322	676617531	4017807398526	93787RD 92868RD BATCN00020 CAP01F250	484	700331	4017807591033	
329	677718000	4017807337686	92804 T6777-00	484	700332	4017807591057	
326	678513001	4017807431070	6289IR-2	484	700387	4017807591071	
324	678710006	4017807337730	T6756-00 6289IR-2 6787IR	485	701031	4017807470321	
				485	701032	4017807470338	
				485	701087	4017807470345	
				485	701131	4017807474824	
				485	701132	4017807474831	

INDEX · NUMERIC

Seite Page	Artikel-Nr. Product No.	EAN-Nummer EAN-Number	Ersatzteile Spare parts	Seite Page	Artikel-Nr. Product No.	EAN-Nummer EAN-Number	Ersatzteile Spare parts
485	701187	4017807474848		495	73043107	4017807505955	T7304-00
491	701231	4017807470352		495	73043131	4017807505931	T7304-00
491	701232	4017807470369		495	73043132	4017807505948	T7304-00
491	701287	4017807470376		496	73060132	4017807577518	G0106-54
486	702031	4017807470383		500	73120102	4017807471557	
486	702032	4017807470390		494	73240107	4017807471564	
486	702087	4017807470406		494	73240108	4017807542684	
486	702131	4017807470475		494	73240131	4017807471571	
486	702132	4017807470482		494	73240132	4017807471588	
486	702187	4017807470499		500	73330101	4017807471595	
486	702231	4017807470505		500	73330111	4017807471618	
486	702231A	4017807474855		497	73430132	4017807506037	
486	702232	4017807470543		496	73520101	4017807471656	
486	702232A	4017807474862		496	73700132	4017807577501	G31702-57
486	702287	4017807470550		501	73820180	4017807505856	
486	702287A	4017807474879		500	76390201	4017807472110	
487	702331	4017807470567		500	76390211	4017807472127	
487	702331A	4017807482171		501	76820280	4017807505832	
487	702331B	4017807518900		498	76921031	4017807505962	T76921-00
487	702332	4017807470574		498	76921032	4017807505979	T76921-00
487	702332A	4017807482188		498	76921087	4017807505986	T76921-00
487	702332B	4017807518924		498	76921531	4017807505993	T76922-00
487	702387	4017807470581		498	76921532	4017807506006	T76922-00
487	702387A	4017807482195		498	76921587	4017807506013	T76922-00
487	702387B	4017807518948		498	77020131	4017807472028	
487	702431	4017807470598		498	77020132	4017807472035	
487	702432	4017807470604		498	77020187	4017807472042	
487	702487	4017807470611		497	78010107	4017807471946	
491	702531	4017807470628		497	78010131	4017807471922	
491	702532	4017807470635		497	78010132	4017807471939	
491	702587	4017807470642		492	78030131	4017807505900	T7803-00
490	703031	4017807471397		492	78030132	4017807505917	T7803-00
490	703032	4017807471403		492	78030187	4017807505924	T7803-00
490	703087	4017807471410		492	78070107	4017807472073	
490	703131	4017807471427		492	78070131	4017807472080	
490	703132	4017807471434		492	78070132	4017807472103	
490	703187	4017807471441		492	78150107	4017807505894	T7815-00
490	703231	4017807471458		492	78150131	4017807505870	T7815-00
490	703232	4017807471465		492	78150132	4017807505887	T7815-00
490	703287	4017807471472		496	78170107	4017807471663	
489	703331	4017807471489		494	78240107	4017807471694	
489	703332	4017807471502		494	78240108	4017807542660	
489	703387	4017807471519		494	78240131	4017807471700	
491	703431	4017807474886		494	78240132	4017807471724	
489	703531	4017807474893		500	78330101	4017807471977	
489	703532	4017807474909		500	78330111	4017807471991	
489	703587	4017807474916		500	78330179	4017807472295	
489	703631	4017807577471		497	78430132	4017807506020	
489	703632	4017807577488		468	800700132	4017807469141	
489	703687	4017807577495		468	800700232	4017807469226	
490	703731	4017807591101		468	800700332	4017807469301	
490	703732	4017807591118		468	800700432	4017807469363	
490	703787	4017807591125		176	801100231	4017807562316	
484	703809	4017807577525		176	801100232	4017807562217	
491	703952	4017807471533		176	801100331	4017807565676	

Seite Page	Artikel-Nr. Product No.	EAN-Nummer EAN-Number	Ersatzteile Spare parts	Seite Page	Artikel-Nr. Product No.	EAN-Nummer EAN-Number	Ersatzteile Spare parts
176	801100332	4017807562231		474	811900131	4017807522815	
176	801170131	4017807585315		148	811900132	4017807522792	
176	801170132	4017807585339		474	811900231	4017807522860	
198	801900167	4017807502558		148	811900232	4017807522877	
198	801900267	4017807502565		474	811900331	4017807522921	
198	801900367	4017807502589		148	811900332	4017807522938	
466	802400101	4017807227543		462	812400107	4017807487947	
466	802400104	4017807490534		462	812400131	4017807487961	
466	802400107	4017807231335		462	812400132	4017807487954	
466	802400124	4017807408621		462	812400207	4017807487978	
466	802400132	4017807408614		462	812400231	4017807487992	
464	802400180	4017807523898		462	812400232	4017807487985	
466	802400201	4017807227550		462	812400307	4017807488005	
466	802400204	4017807490558		462	812400331	4017807488029	
466	802400207	4017807231359		462	812400332	4017807488012	
466	802400224	4017807408645		462	812400407	4017807488036	
466	802400232	4017807408638		462	812400431	4017807488067	
464	802400280	4017807523911		462	812400432	4017807488043	
466	802400301	4017807227567		476	813400127	4017807540789	
466	802400304	4017807490572		476	813400227	4017807540833	
466	802400307	4017807231373		476	813400427	4017807540857	
466	802400324	4017807408669		476	813430327	4017807540864	
466	802400332	4017807408652		456	821410305	4017807220902	92426
464	802400380	4017807523935					92426-35
466	802430401	4017807227574					959-745
466	802430404	4017807490596		456	821410405	4017807220919	92426
466	802430407	4017807231397					92426-35
466	802430424	4017807408683					959-745
466	802430432	4017807408676		456	821410605	4017807220933	92426
464	802430480	4017807523959					92426-35
470	803000107	4017807348262					959-745
470	803000207	4017807348279		457	821430405	4017807220926	92426
470	803000307	4017807348286					92426-35
470	803090307	4017807348323					959-745
202	803400167	4017807430196		457	821470105	4017807220889	92426
202	803400267	4017807430202					92426-35
202	803400367	4017807430219					959-745
471	803500131	4017807408201	S8035-02	456	821470205	4017807220896	92426
471	803500132	4017807408225	S8035-02				92426-35
471	803500231	4017807408232	S8035-02				92389-01
471	803500232	4017807408249	S8035-02	473	871010107	4017807281637	92734
471	803500331	4017807408256	S8035-02	473	871010108	4017807281644	92734
471	803500332	4017807408263	S8035-02	472	871010207	4017807281651	92734
208	804300332	4017807467666		472	871010208	4017807281668	92734
208	804300432	4017807467680		472	871010307	4017807281675	92734
208	804370132	4017807467604		472	871010308	4017807281682	92734
208	804370232	4017807467642		472	871010407	4017807281712	92734
210	805300188	4017807445183		472	871010408	4017807281729	92734
210	805300288	4017807445190		472	871010607	4017807281736	92734
210	805300388	4017807445206		472	871010608	4017807281743	92734
210	805300488	4017807445213		473	871090307	4017807281699	92734
132	811400132	4017807538335		473	871090308	4017807281705	92734
132	811400232	4017807538359		458	873110307	4017807302615	T87313-00
132	811400432	4017807538397		458	873110331	4017807302622	T87313-00
132	811430332	4017807538373		458	873110407	4017807302639	T87314-00

INDEX · NUMERIC

Seite Page	Artikel-Nr. Product No.	EAN-Nummer EAN-Number	Ersatzteile Spare parts	Seite Page	Artikel-Nr. Product No.	EAN-Nummer EAN-Number	Ersatzteile Spare parts
458	873110431	4017807302646	T87314-00	555	986-4813	4017807586725	
459	873110607	4017807302653		554	986-60	4017807280647	
459	873110631	4017807302660		554	986-63	4017807280654	
458	873170107	4017807302578		556	986-6790	4017807509120	
458	873170131	4017807302585		556	986-6810	4017807358766	
458	873170207	4017807302592		557	986-710	4017807433463	
458	873170231	4017807302608		555	987-2400	4017807303933	
536	880400106	4017807508031		555	987-2479	4017807509113	
536	880400132	4017807508048		554	987-260	4017807509090	
536	880400406	4017807508383		554	987-400	4017807287509	
536	880400432	4017807508390		555	987-410	4017807394917	
536	880430306	4017807508369		555	987-479	4017807509106	
536	880430332	4017807508376		557	987-4813	4017807579123	
370	891010107	4017807358049	92734	554	987-60	4017807279252	
370	8911211-07	4017807118780		557	987-600	4017807288056	
558	901-479	4017807351446		555	987-6700	4017807387636	
558	902-479	4017807351453		557	987-679	4017807288049	
558	903-479	4017807351460		554	987-6810	4017807358735	
558	904-479	4017807351477		554	987-7009	4017807508949	
562	929-220	4017807293319		555	987-740	4017807579079	
562	929-230	4017807355000		554	987-909	4017807508956	
562	929-2300	4017807394924		554	988-10	4017807300338	
211	92945	4017807478174		554	988-110	4017807394894	
563	955-50	4017807277074		557	988-4813	4017807579147	
561	955-55	4017807277098		556	988-600	4017807287516	
562	956-30	4017807277050		556	988-679	4017807287530	
562	956-330	4017807509151		554	988-700	4017807394887	
562	956-355	4017807509144		557	988-710	4017807433449	
562	956-44	4017807579062		556	988-901	4017807579093	
562	956-509	4017807508987		560	989-200	4017807508864	
563	956-55	4017807300369		560	989-279	4017807508871	
563	956-5736	4017807380057		560	989-3200	4017807508918	
563	956-5936	4017807380071		560	989-3279	4017807508925	
560	983-200	4017807508840		560	989-3400	4017807543162	
560	983-279	4017807508857		559	989-40	4017807240597	
561	983-3200	4017807508901		560	989-400	4017807287486	
561	983-3279	4017807508932		559	989-43	4017807260557	
561	983-3400	4017807543155		560	989-4470	4017807358926	
559	983-40	4017807240566		560	989-479	4017807287523	
560	983-400	4017807302097		560	989-4790	4017807509083	
560	983-410	4017807394900		559	989-509	4017807508970	
559	983-43	4017807260540		559	989-56	4017807394870	
561	983-440	4017807579086		559	989-60	4017807279238	
561	983-4470	4017807358940		559	989-63	4017807279245	
560	983-479	4017807530612		559	989-66	4017807300352	
561	983-4790	4017807509137		560	990-200	4017807508895	
561	983-4813	4017807579109		560	990-279	4017807508888	
559	983-509	4017807508963		559	990-40	4017807240610	
559	983-56	4017807394863		560	990-400	4017807287493	
559	983-60	4017807279214		560	990-4470	4017807358933	
559	983-63	4017807279221		560	990-4790	4017807509076	
559	983-66	4017807300345					
556	985-6810	4017807358759					
554	986-40	4017807268782					
554	986-43	4017807268799					

GARANTIEERKLÄRUNG

Warranty Statement · Déclaration de garantie · Garantieverklaring · Declaración de garantía · Dichiarazione di garanzia · Declarație de garanție · Takuuehdot · Oświadczenie o gwarancji



Ⓓ

Als innovatives und zukunftsorientiertes Unternehmen legen wir großen Wert auf die Qualität und Zuverlässigkeit unserer Produkte. Alle unsere Sortimentsartikel unterliegen einer strengen Qualitätskontrolle. Sollte ein Produkt wider Erwarten nicht einwandfrei funktionieren oder Mängel aufweisen, übernehmen wir gegenüber Verbrauchern für alle LED-Leuchten mit fest verbauten LEDs eine freiwillige Funktionsgarantie von 5 Jahren. Nähere Informationen finden Sie in der Garantieerklärung auf unserer Internetseite.

www.trio-leuchten.de

ⒼⒹ

As an innovative, forward-thinking company, we place great value on the quality and reliability of our products. All the items in our range are subject to strict quality control. Should a product, contrary to expectations, show faulty function or defects, we provide consumers with a voluntary functional guarantee of 5 years for all LED luminaires with permanently installed LEDs. For further information, please visit our website.

www.trio-lighting.com

ⒻⓇ

En tant qu'entreprise innovante orientée vers l'avenir, nous accordons une grande importance à la qualité et à la fiabilité de nos produits. Tous les articles de notre gamme sont soumis à des contrôles-qualité stricts. Si contre toute attente un produit devait ne pas fonctionner correctement ou présenter des vices, nous offrons aux consommateurs une garantie de fonctionnement de 5 ans pour tous les luminaires disposant de LED permanentes. Pour plus d'information, consultez notre site.

www.trio-lighting.com

ⒼⓁ

Als innovatieve en toekomstgerichte onderneming hechten wij veel belang aan de kwaliteit en betrouwbaarheid van onze producten. Alle artikelen uit ons assortiment worden onderworpen aan een strenge kwaliteitscontrole. Indien een product tegen de verwachting in niet foutloos functioneert of gebreken vertoont, bieden wij consumenten een vrijwillige fabrieksgarantie van 5 jaar op alle verlichtingstoestellen met permanent geïnstalleerde leds. Voor meer informatie, consulteer onze website.

www.trio-lighting.com

ⒺⓈ

Como empresa innovadora y con la vista puesta en el futuro, le damos una gran importancia a la calidad y la fiabilidad de nuestros productos. Todos los artículos de nuestro catálogo están sujetos a un estricto control de calidad. En aquellos casos en los que, contrariamente a lo previsto, un producto presente algún defecto o un funcionamiento deficiente, ofrece a los usuarios una garantía funcional de 5 años en todos sus artículos de iluminación que cuentan con luces LED instaladas. Para más información, por favor visite nuestra página web.

www.trio-lighting.com

Ⓙ

In quanto azienda orientata all'innovazione e proiettata nel futuro, riponiamo un grande valore nella qualità e nell'affidabilità dei nostri prodotti. Tutti gli articoli del nostro assortimento vengono sottoposti a un rigido controllo della qualità. Nel caso in cui un prodotto dovesse presentare, contro ogni aspettativa, malfunzionamenti o difetti, offriamo ai consumatori una garanzia di funzionamento facoltativa di 5 anni per tutti gli apparecchi LED installati in modo permanente. Per ulteriori informazioni, vi preghiamo di visitare il nostro sito web.

www.trio-lighting.com

ⓇⓄ

În calitate de companie inovatoare și orientată spre viitor punem mare accent pe calitatea și siguranța produselor noastre. Toate sortimentele noastre sunt supuse unui control riguros de calitate. Dacă un produs nu funcționează ireproșabil conform așteptărilor sau prezintă defect, vă oferim consumatorilor o garanție voluntară operațională de 5 ani pentru toate de iluminat cu LED-uri permanent instalate. Pentru mai multe detalii, va rugăm să vizitați site-ul.

www.trio-lighting.com

Ⓕ

Innovatiivisena ja tulevaisuuteen katsovana yrityksenä kiinnitämme erityistä huomiota tuotteidemme laatuun ja luotettavuuteen. Kaikki valikoimamme tuotteet ovat tiukan laadunvalvonnan alaisia. Siltä varalta, että tuotteemme ei vastoin odotuksia toimikaan moitteettomasti tai siinä on vika, myöntää kuluttajille vapaaehtoisesti 5 vuoden toimintakuun kaikille pysyvästi asennetuille LED-valoille.

Lisätietoja verkkosivuiltamme.

www.trio-lighting.com

Ⓟ

Jako innowacyjne i ukierunkowane na przyszłość przedsiębiorstwo przykładamy dużą wagę do jakości i niezawodności naszych produktów. Wszystkie artykuły z naszego asortymentu poddawane są surowej kontroli jakości. Jeśli produkt mimo oczekiwań nie działa prawidłowo lub jest uszkodzony, oferujemy dobrowolną 5-letnią gwarancję funkcjonalną na wszystkie oprawy oświetleniowe z zamontowanymi na stałe diodami LED. Na naszej stronie internetowej może Państwo uzyskać więcej informacji na ten temat.

www.trio-lighting.com

KONTAKTE

Contact · Contact · Contact · Contactar · Contatto · Contact · Yhteydenotto · Kontakt

TRIO Leuchten GmbH

Gut Nierhof 17
D-59757 Arnsberg

T +49 (0) 2931 9666-0
F +49 (0) 2931 9666-57

info@trio-leuchten.de
www.trio-leuchten.de

BADEN WÜRTTEMBERG, RHEINLAND-PFALZ UND SAARLAND

Antonio De Simone

T +49 (0) 151 5855222
antonio.desimone@trio-leuchten.de

BAYERN, HESSEN

Martin Kluge

T +49 (0) 171 7300330
martin.kluge@trio-leuchten.de

BERLIN, BRANDENBURG, MECKLENBURG-VORPOMMERN, SACHSEN, SACHSEN ANHALT, THÜRINGEN

Jörg Bumke

T +49 (0) 160 7406860
joerg.bumke@trio-leuchten.de

BREMEN, HAMBURG, NIEDERSACHSEN, SCHLESWIG-HOLSTEIN

Jens Gebers

T +49 (0) 170 1615227
jens.gebers@trio-leuchten.de

NORDRHEIN-WESTFALEN

Christian Teller

T +49 (0) 171 4521820
christian.teller@trio-leuchten.de

ÖSTERREICH

Wolfgang Melich

T +43 (0) 6605161228
wolfgang.melich@trio-leuchten.de

SCHWEIZ

TRIO Leuchten

T +49 (0) 2931 9666-0
info@trio-leuchten.de

 /trioleuchten

 @trio.lighting

 @trioleuchten

 @TRIO Lighting Group

 @trio.lighting



TRIO International GmbH

Gut Nierhof 17
D-59757 Arnsberg
T +49 (0) 2931 9666-587
F +49 (0) 2931 9666-56
info@trio-lighting.com
www.trio-lighting.com

FRANCE

Stéphane Papierny

Directeur Commercial France
info.france@trio-lighting.com

Jean Philippe Bailly

info.france@trio-lighting.com
Agent exclusif pour les départements
60, 75 Nord, 92, 93 et 95

Jean Barel / Thomas Wroz

info.france@trio-lighting.com
Agent exclusif pour les départements
09, 12, 15, 16, 19, 24, 31, 32, 33, 40, 46,
47, 64, 65, 81, 82 et 87

Jean Marc Beneforti

info.france@trio-lighting.com
Agent exclusif pour les départements
2a et 2b

Christophe Meulien

info.france@trio-lighting.com
Agent exclusif pour les départements
04, 05, 06, 11, 13, 30, 34, 66, 83 et 84

Sullivan Nicolas

info.france@trio-lighting.com
Agent exclusif pour les départements
01, 03, 07, 21, 23, 26, 38, 39, 42,
43, 48, 63, 69, 71, 73 et 74

Stéphane Riebel

info.france@trio-lighting.com
Agent exclusif pour les départements
18, 45, 58, 75 Sud, 77, 78, 89, 91 et 94

Michel Salamand

info.france@trio-lighting.com
Agent exclusif pour les départements
14, 17, 22, 29, 35, 36, 37, 41, 44, 49, 50,
53, 56, 61, 72, 79, 85 et 86

Elsa Seron

info.france@trio-lighting.com
Agent exclusif pour les départements
27, 28 et 76

Vincent Zaeppfel

info.france@trio-lighting.com
Commercial pour les départements
02, 08, 10, 25, 51, 52, 54, 55, 57, 59, 62,
67, 68, 70, 80, 88 et 90

DANMARK

Jan Rantzau-Bartens

info.denmark@trio-lighting.com

NORDIC & BALTIC

TRIO Lighting Scandinavia Oy

Malmin raitti, rappu 17 B
00700 Helsinki
T +358 (0) 10 23 13 390
tls@trio-lighting.com

*Our Scandinavian organisation represents TRIO
also in Sweden, Norway, Estonia, Latvia, Lithuania
and Iceland*

ITALIA

TRIO Lighting Italia s.r.l

Via Isonzo 81
22066 Mariano Comense (CO)
commerciale@trio-lighting.com

ESPAÑA

TRIO Lighting Ibèrica SL

C/ Can Lietget n°9 nave 9
Pol. Ind. Can Roqueta
08206 Sabadell
T +34 (0) 9 35 45 86 30
F +34 (0) 9 33 96 45 48
info.iberica@trio-lighting.com

GREAT BRITAIN

TRIO Lighting UK Ltd.

Unit 5, Hemmells Park Hemmells, Laindon
Essex
SS1s 6GF
T +44 (0) 12 68 88 95 95
F +44 (0) 12 68 88 95 96
sales@triolightinguk.com

NEDERLAND

Karl Stok / Bas Martin

info.nederland@trio-lighting.com

BELGIUM

Yves Van den Berghe

info.belgium@trio-lighting.com

ROMANIA

Gina Ionita / Loredana Barbu

info.romania@trio-lighting.com
loredana.barbu@trio-lighting.com

SAVE THE DATE



**LICHTWOCHE
SAUERLAND**

25.02. – 01.03.2024

lichtforumnrw

Mitglied der Trägergesellschaft Lichtforum NRW e.V.
Member of the supporting organisation Lichtforum NRW e.V.

TRIO behält sich das Recht vor, zu jeder Zeit, notwendige Änderungen oder Aktualisierungen der in diesem Katalog enthaltenen Produkte vorzunehmen. · TRIO reserves the right to carry out any time, necessary changes or updates of the products in this catalogue. · TRIO se réserve le droit d'apporter à tout moment les modifications ou actualisations nécessaires aux produits dans ce catalogue. · TRIO behoudt zich het recht voor op ieder moment noodzakelijke wijzigingen of updates aan de producten in deze catalogus door te voeren. · TRIO se reserva , en todo momento, el derecho a realizar las modificaciones o actualizaciones que considere necesarias para cualquier producto de este catálogo. · TRIO si riserva il diritto di apportare, in qualunque momento, tutte le modifiche necessarie ai prodotti di questo catalogo. · TRIO-ul își rezervă dreptul de a face oricând orice modificări sau actualizări necesare pentru produsele din acest catalog. · TRIO pidättää oikeuden tehdä muutoksia tai päivittää tuotteita tässä luettelossa. · TRIO zastrzega sobie prawo do wprowadzania w dowolnym czasie zmian lub aktualizacji produktów zawartych w katalogu.



TRIO Leuchten GmbH

Gut Nierhof 17
D-59757 Arnsberg
T +49 (0) 2931 9666-0
F +49 (0) 2931 9666-28
info@trio-leuchten.de
www.trio-leuchten.de

TRIO International GmbH

Gut Nierhof 17
D-59757 Arnsberg
T +49 (0) 2931 9666-587
F +49 (0) 2931 9666-56
info@trio-lighting.com
www.trio-lighting.com



LIGHTING FOR YOU