

 **rendl**
light
studio

2 0 2 3

CATÁLOGO
DE ILUMINAÇÃO





ÍNDICE

GLOSSÁRIO	4-5
CANDEEIROS SUSPENSOS	6-95
CANDEEIROS DE TETO	96-191
CANDEEIROS DE PAREDE	192-283
FOCOS	284-335
CANDEEIROS DE MESA	336-359
CANDEEIROS DE PÉ	360-375
LUZES EMBUTIDAS	376-485
CALHAS TRIFÁSICAS	486-513
SISTEMA DE CALHAS MONOFÁSICAS	514-531
FITAS LED	532-561
ABAJURES E ACESSÓRIOS	562-617
ILUMINAÇÃO EXTERIOR	618-725
FONTES DE LUZ	726-743
ACESSÓRIOS PARA CANDEEIROS	744-751
LISTA ALFABÉTICA DE LUZES	752-755
IDENTIFICAÇÃO ÍNDICE	756-759

GLOSSÁRIO



NOME

Descrição

PRODUTO

230 V/350 mA LED... Informação técnica

IDENTIFICAÇÃO DO ARTIGO cor / material

PREÇO ➔



↑ 50

● Ø40

● **LED**

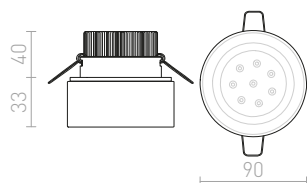

- está incluído
- não está incluído
- ↑ profundidade necessária (em mm)
- diâmetro do furo redondo (em mm)
- ▣ dimensão do furo quadrado (em mm)
- ∩^{20°} ângulo de inclinação
- ∩^{90°} ângulo de rotação
- ▭⁴⁴ dimensão (em mm)
- NEW novo
- % mercadorias a preço reduzido
- ➔ stock de apuramento, descontinuado

Os valores do fluxo luminoso especificados são valores nominais gerados pela fonte de luz. O fluxo luminoso será menor devido à perda causada pela parte óptica da fixação.

Os valores específicos do consumo de energia são os valores nominais do consumo pela fonte de luz. O consumo de energia total do acessório será aumentado pela perda causada pela resistência.

O fabricante reserva-se ao direito de fazer alterações nos parâmetros dos produtos individuais durante a validade do catálogo.

% e ➔ – produtos estão em quantidade limitada e sua disponibilidade não é garantida durante a validade do catálogo.

GARANTIA ALARGADA

A garantia padrão fornecida a todos os clientes É DE DOIS ANOS.

Uma GARANTIA ALARGADA CONTRATUAL pode ser providenciada para um projeto individual maior. É determinado pelo tipo de mercadoria, volume e duração da garantia. Peça uma cotação.

EXCLUSÃO DE RESPONSABILIDADE

As alterações estão sujeitas a aviso prévio. Erros e omissões são reservados. Verifique sempre se está a consultar a versão mais recente.

Ao usar outras fontes de luz ou acessórios que não sejam os recomendados por nós, não podemos garantir a funcionalidade da lâmpada.

IP REQUERIDO

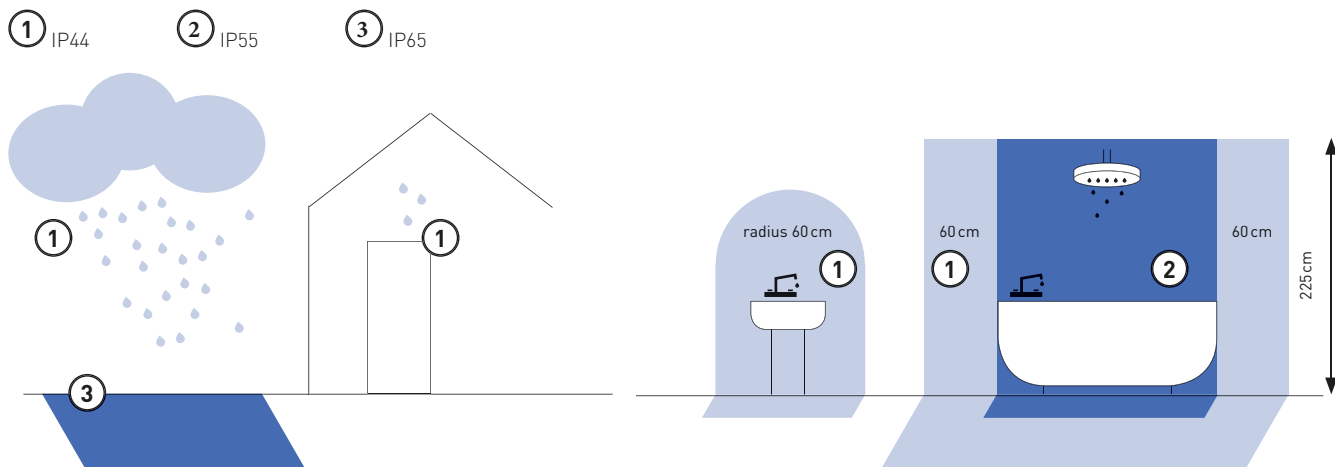

INSTALAÇÃO DE LUZES EXTERNAS EMBUTIDAS

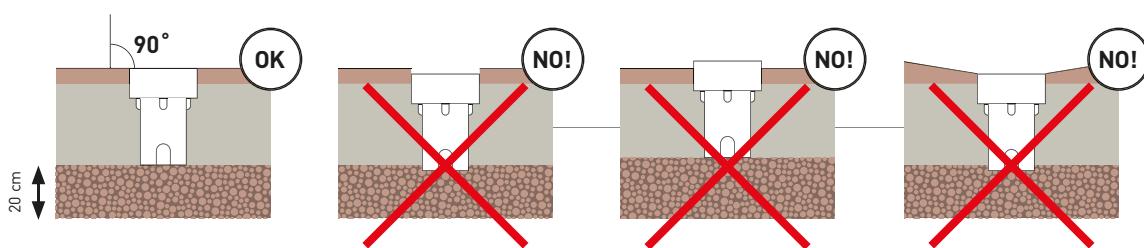

LED Integrado



G53 Halogéneo

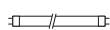

T5 Tubo fluorescente

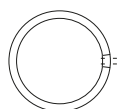

2GX13 Tubo fluorescente



G11841

Fonte recomendada, mais informações na categoria Fontes de luz.



Transformador não regulável.



regulável

Luz com driver TRIAC regulável.



regulamento opcional

Por um custo adicional, a luz pode ser fornecida com um interruptor ajustável.



G13002

Driver recomendado, mais informações na categoria Acessórios para candeeiros.



Interruptor de alavanca



Interruptor de toque com regulação



Interruptor no cabo



Interruptor de empurrar



Interruptor de puxar



Interruptor elétrico



Interruptor de toque



Interruptor rotativo



PIR

Sensor PIR, sensor de movimento por infravermelhos.



MW

Sensor MW, Sensor de movimento por microondas.



1800K → 3000K
DIMM TO WARM

DIMM TO WARM, controlo de temperatura de cor da luz.



CANDEEIROS SUSPENSOS

DECORATIVO	14-39
VIDRO	40-59
AJUSTÁVEL	60-65
MÚLTIPLO	66-67
METÁLICO	68-77
SUBTIL	78-81
TÉCNICO, CIRCULAR	82-85
TÉCNICO, ANGULAR	86-89
OBLONGO	90-93
INDUSTRIAL	94-95

SUSPENSOS DECORATIVO

14-39



ARAQ
14-15



AGNETA
14-15



COPA
14-15



DESTY I
14-15



ASTRAL
16-17



ASTROMET VII
16-17



BISOU 40
18-19



BEAU MONDE 25
18-19



BEAU MONDE 30
18-19



BEAU MONDE 35
18-19



ENCOMBRE
20-21



CONFETTI
20-21



COCO
20-21



ZALA
22-23



RARA
22-23



EZRA 40
22-23



CLANK
22-23



GLAMOUR 35/20
24-25



AINO 40
24-25



EL DORADO 43
24-25



FIATLUX 41/24
26-27



FANCY 35/25
26-27



FANCY 50/30
26-27



LALO 40
28-29



LALO 55
28-29



LOPE 80
28-29



AMICI
28-29



BUCKY 40
30-31



VESCO
30-31



JAMAICA 34
30-31



POLLOCK
30-31



ESPLANADE
32-33



ICAR
32-33



CHOUPELLE
32-33



ESME 76
34-35



NANCY III
34-35



TUTTI
34-35



FRUTTI
34-35



FLORIDA
36-37



HEIDI
36-37



RADICAL
36-37



ELLA
36-37



CAMINO
38-39



BURTON
38-39



ILUSIA
38-39

SUSPENSOS VIDRO

40-59



BELLINI L E14
40-41



BELLINI M LED
40-41



AZRIA
40-41



CORONA
40-41



PULIRE CON
42-43



PULIRE RD
42-43



COROA NEW 28
42-43



DORA
42-43



BOLLY 17
44-45



LUNA 20
44-45



LUNA 25
44-45



LUNA 30
44-45



LUNEA 30
46-47



LUNEA 40
46-47



LUNEA 50
46-47



JULIETTA 16
48-49



JULIETTA 31
48-49



BABU NEW 22
48-49



SANSSOUCI I
50-51



GARNISH
50-51



TOMBA
52-53



EIGHT
52-53



JACK RC
52-53



ESTRA I
54-55



ESTRA V
54-55



GIFT I
54-55



DADOS NEW
56-57



LIZ NEW
56-57



ASTERI
58-59



CASSABLANCA 40
58-59

SUSPENSOS AJUSTÁVEL

60-65



BROADWAY
60-61



LEVITA
60-61



BROADWAY
62-63



MADISON C
62-63



LOYD LED I
64-65



LOYD E27 I
64-65



LOYD E27 III
64-65

SUSPENSOS MÚLTIPLO

66-67



VIPER III
66-67



CINDY VI
66-67

SUSPENSOS METÁLICO

68-77



GIULIA 12
68-69



GIULIA 20
68-69



GIULIA 40
68-69



ASTON 28
70-71



ASTON 30
70-71



BLONDIE 25
70-71



MARGO
70-71



MONROE 30
72-73



MONROE 40
72-73



SINTRA 30
72-73



SINTRA 40
72-73



GOLDIE 36
74-75



GOLDIE 46
74-75



MERYLYN 34, 48
74-75



BABADES I
76-77



BABADES IV
76-77



CARISSIMA 25
76-77



CARISSIMA 40
76-77

SUSPENSOS SUBTIL

78-81



MAVRO
78-79



RIGA 28
78-79



BOGARD
80-81



BOGARD
80-81



BELENOS
80-81



OPTIMUS
80-81

SUSPENSOS TÉCNICO, CIRCULAR

82-85



MEZZO 40
82-83



MEZZO 60
82-83



MEZZO 80
82-83



MENSA R 60
84-85



MONETA
84-85



LARISA R 30
84-85

SUSPENSOS TÉCNICO, ANGULAR

86-89



MENSA SQ 48
86-87



MENSA RC
86-87



LARISA SQ 30
86-87



STRUCTURAL LED 20x20
88-89



STRUCTURAL LED 40x40
88-89



STRUCTURAL LED 55x55
88-89

SUSPENSOS OBLONGO



PESANTE 35
90-91



PESANTE 75
90-91



INDIGO
90-91

90-93



BERLINO
90-91



TRIDENT PRO 120
92-93



TRIDENT PRO 150
92-93



TRIDENT PRO
92-93

SUSPENSOS INDUSTRIAL



MEGALOS PRO 26
94-95



MEGALOS PRO 30
94-95



MEGALOS PRO 35
94-95

94-95



AGNETA

Luminária suspensa redonda de metal para uso com uma fonte de luz E27 adequada.

AGNETA SUSPENSO

230 V E27 40 W

R13897 branco

€ 68 NEW

R13898 preto

€ 68 NEW

R13899 latão escovado

€ 98 NEW

R13900 cobre escovado

€ 98 NEW

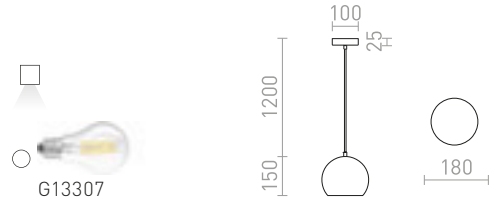

ARAQ

Luminária suspensa com casquilho em latão, cabo têxtil e base lacada a preto. Para uso com uma fonte de luz decorativa E27 adequada.

ARAQ SUSPENSO

230 V E27 42 W

R13891 latão escovado/preto

€ 35 NEW

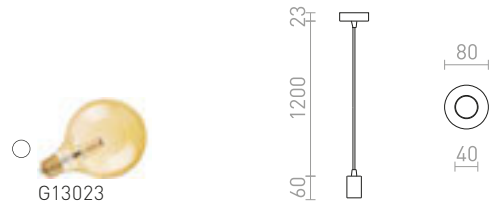

DESTY

Luminária suspensa com abajur e base de teto em cromo ou cobre. A versão cromada vem com um cabo têxtil preto. A versão cobre tem um cabo têxtil vermelho.

DESTY | SUSPENSO

230 V GU10 35 W

R12085 vermelho/cobre

€ 78 %

R12086 preto/cromo

€ 78

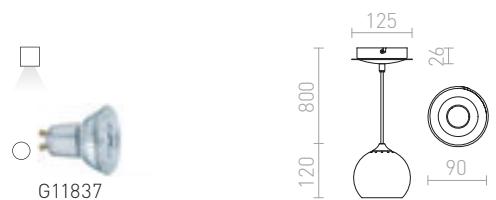



COPA

Luminária suspensa com abajur de vidro disponível em duas cores.

COPA SUSPENSO

230 V E27 28 W

R11823 vidro colorido opala

€ 178

R11824 preto/vidro

€ 178

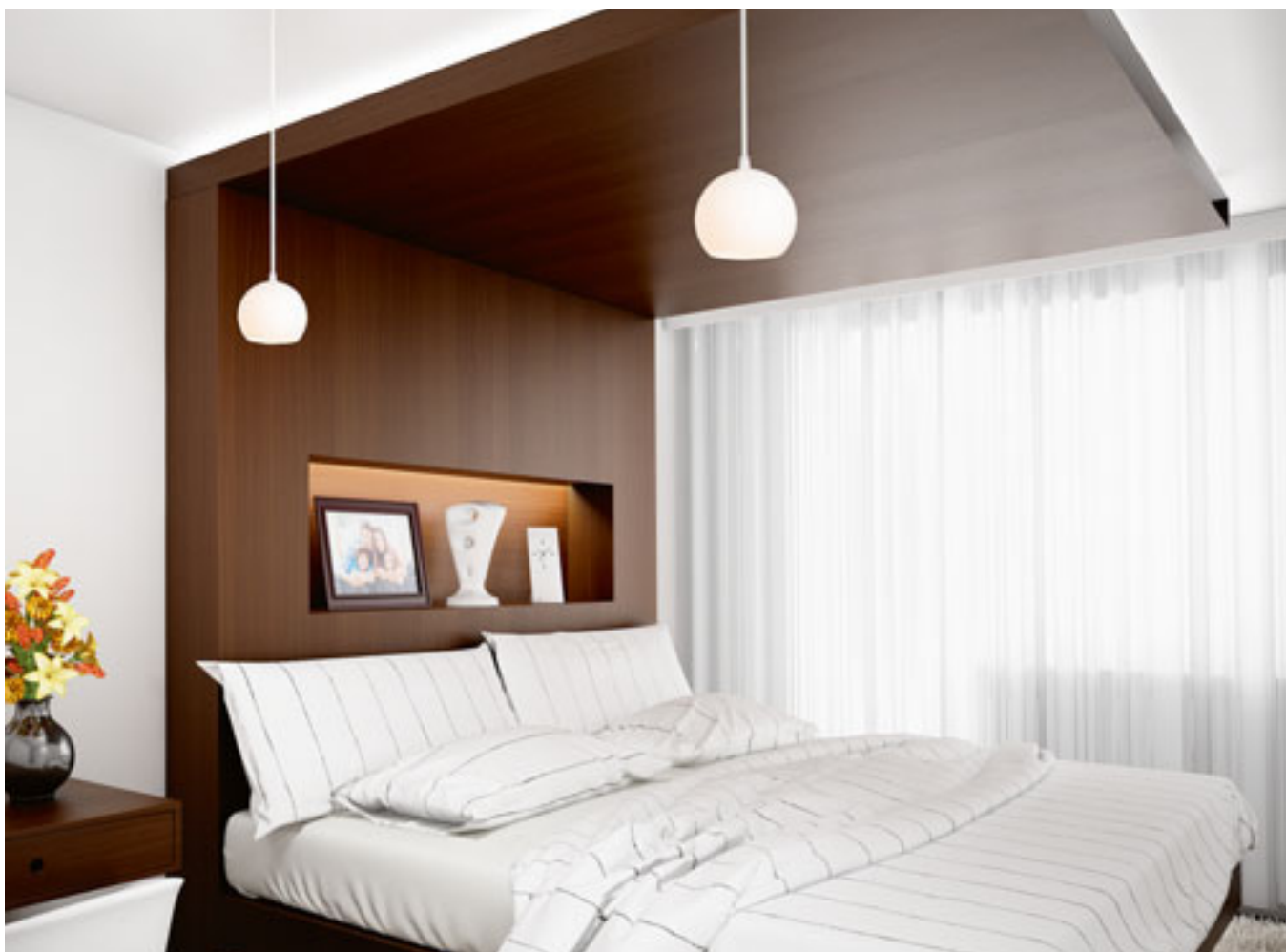
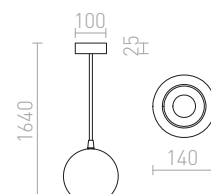





ASTRAL

Luminária suspensa de design com abajures de vidro semi-colorido. Os abajures podem ser montados em várias formas. Um anel decorativo é usado para ajustar o ângulo de inclinação.

ASTRAL SUSPENSO

230 V/12 V G4 10x20 W

R10513 vidro cromado/vidro transparente € 620

R11706 vidro tingido de cobre/vidro transparente € 620



G13035

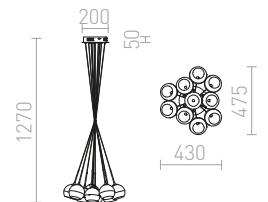

ASTROMET

Luminária suspensa composta por sete esferas de cromo anexadas a uma base de teto, com casquilhos E27.

ASTROMET VII SUSPENSO

230 V E27 7x42 W

R11761 cromo € 360



G13014

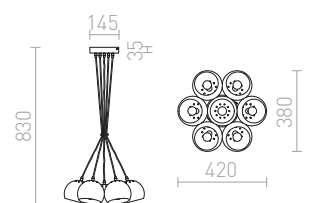



BISOU

Luminária suspensa com abajur de vidro transparente e acessórios cromados. Para fontes de luz eficientes em energia com casquilho E27. Pequenas bolhas no vidro são causadas pelo processo de produção e não é um defeito do abajur.

BISOU 40 SUSPENSO

230 V E27 25 W

R10506 vidro transparente/cromo

€ 380 →

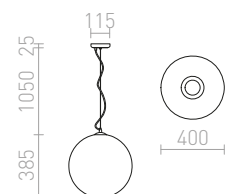



BEAU MONDE

Luminária suspensa com abajur de vidro soprado à mão. A aparência do espelho do abajur é conseguida por um método especial no qual uma fina camada de metal é aplicada ao vidro. Para fontes de luz E27 de baixo consumo energético. O processo de fabrico origina pequenas bolhas no vidro, não sendo defeitos, são efeitos causados na sua fabricação.

BEAU MONDE 25 SUSPENSO

230 V E27 25 W

R10517 vidro tingido de cobre

€ 215

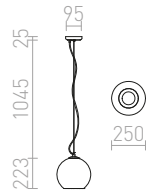

BEAU MONDE

Luminária suspensa com abajur de vidro soprado à mão. A aparência do espelho do abajur é conseguida por um método especial no qual uma fina camada de metal é aplicada ao vidro. Para fontes de luz E27 de baixo consumo energético. O processo de fabrico origina pequenas bolhas no vidro, não sendo defeitos, são efeitos causados na sua fabricação.

BEAU MONDE 30 SUSPENSO

230 V E27 25 W

R10518 vidro cromado

€ 320

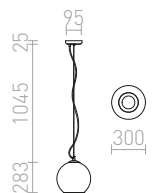

BEAU MONDE

Luminária suspensa com abajur de vidro soprado à mão. A aparência do espelho do abajur é conseguida por um método especial no qual uma fina camada de metal é aplicada ao vidro. A parte inferior do abajur é feita de vidro transparente. Para fontes de luz E27 de baixo consumo energético. O processo de fabrico origina pequenas bolhas no vidro, não sendo defeitos, são efeitos causados na sua fabricação.

BEAU MONDE 35 SUSPENSO

230 V E27 25 W

R10516 vidro cromado/vidro transparente

€ 360

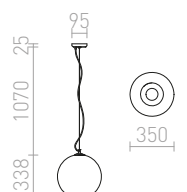



ENCOMBRE

Luminária decorativa suspensa feita de pétalas de plástico disponível em três cores. Fornecido desmontado, montagem necessária.

ENCOMBRE SUSPENSO

230 V E27 42 W

R12381 PVC branco

€ 129

R12382 folha de cromo

€ 158

R12383 folha de cobre

€ 158



G13026

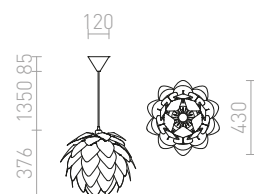

COCO

Luminária decorativa suspensa feita de elementos plásticos com design de botões de rosa. Fornecido desmontado, montagem necessária.

COCO SUSPENSO

230 V E27 28 W

R12384 PVC branco

€ 238



G13026

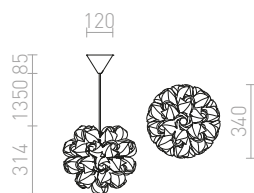



CONFETTI

Candeeiro divertido com camadas de grandes lantejoulas feitas de lâmina cromada. Fornecido desmontado, montagem necessária.

CONFETTI SUSPENSO

230 V E27 28 W

R13285 folha de cromo

€ 98

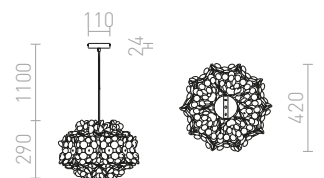
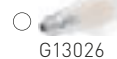



ZALA

Candeeiro suspenso com tiras decorativas de plástico. Fornecido desmontado, montagem necessária.

ZALA SUSPENSO

230 V E27 15 W

R13315 PVC branco/preto

€ 48 %

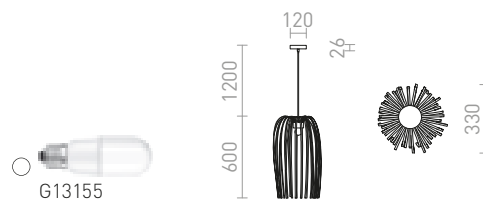

RARA

Candeeiro suspenso com tiras decorativas de plástico. Fornecido desmontado, montagem necessária.

RARA SUSPENSO

230 V E27 15 W

R13316 PVC branco/preto

€ 48 %

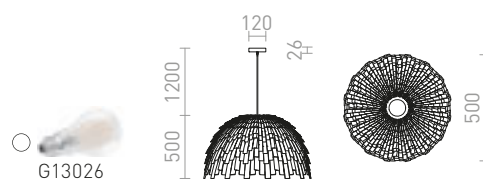



CLANK

Candeeiro suspenso com tiras decorativas de plástico.
Fornecido desmontado, montagem necessária.

CLANK SUSPENSO

230 V E27 15 W

R13321 PVC branco/preto

€ 78 %

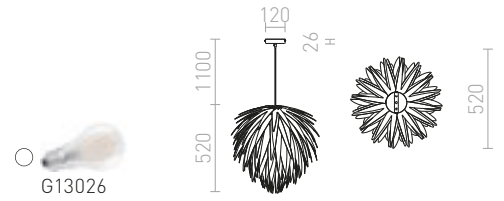

EZRA

Abajur de plástico redondo com textura decorativa.
Fornecido desmontado, montagem necessária.

EZRA 40 SUSPENSO

230 V E27 15 W

R13319 PVC branco/cinza

€ 58 %

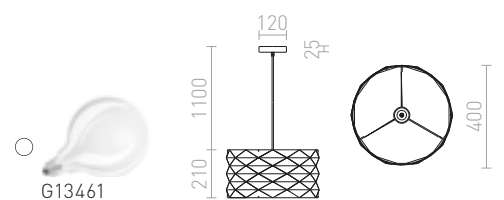



AINO

Candeeiro suspenso com abajur padrão de malha cinzento.

AINO 40 SUSPENSO

230 V E27 28 W

R13275 cinzento/cromo

€ 129 %

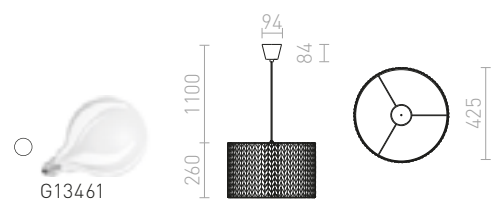



EL DORADO

Abajur suspenso em couro sintético com uma textura subtil.

EL DORADO 43 SUSPENSO

230 V E27 28 W

R13359 ouro/folha de cromo

€ 98 %

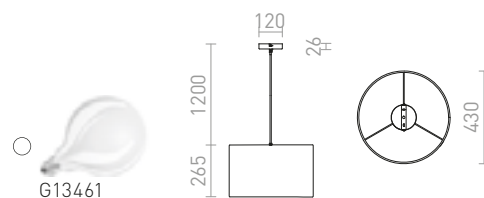

GLAMOUR

Candeeiro suspenso com abajur em fitas pretas.

GLAMOUR 35/20 SUSPENSO

230 V E27 28 W

R13271 preto

€ 58 %

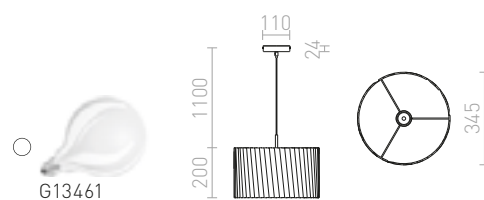



FANCY

Candeeiro suspenso decorativo com abajur em folha de cromo. Quando a lâmpada está acesa, ela torna-se semi-transparente e, quando desligada, possui uma superfície refletora.

FANCY 35/25 SUSPENSO

230 V E27 15 W

R13418 folha de cromo

€ 120 →

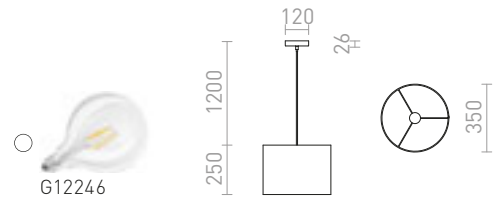

FANCY 50/30 SUSPENSO

230 V E27 20 W

R13419 folha de cromo

€ 158

R13748 película fumada

€ 178 →

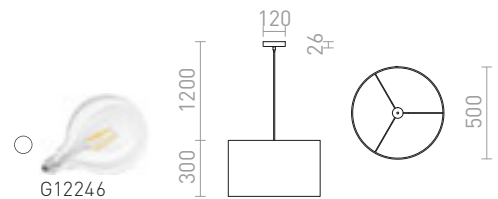

FIATLUX

Candeeiro suspenso preto de bambu.

FIATLUX 41/24 SUSPENSO

230 V E27 15 W

R13398 preto/bambu

€ 98 →

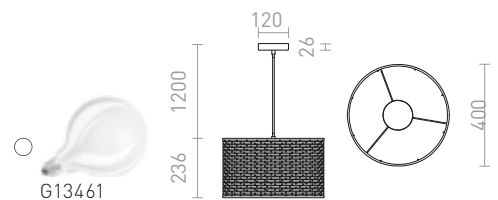





AMICI

Luminária suspensa com abajur de silicone.

AMICI SUSPENSO DE SILICONE

230 V E27 42 W

R10620 verde

€ 12 %



G13026

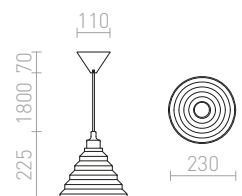



LALO

Candeeiro suspenso com abajur finamente plissado de cor creme. A luminária tem casquilho E27, revestido com difusor acrílico mate.

LALO 40 SUSPENSO

230 V E27 3x42 W

R10605 branco creme/níquel mate

€ 238

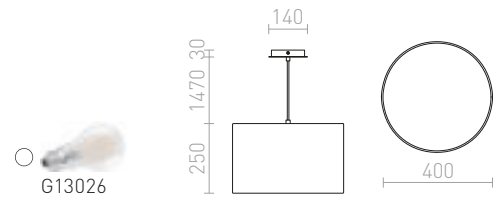

LALO 55 SUSPENSO

230 V E27 3x42 W

R10540 branco creme/níquel mate

€ 278

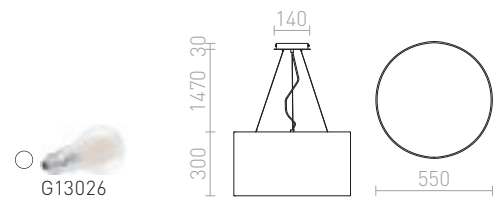

LOPE

Luminária suspensa com abajur finamente plissado em preto para quatro fontes de luz com casquilho E27. As fontes de luz são cobertas com um difusor acrílico mate.

LOPE 80 SUSPENSO

230 V E27 4x42 W

R10539 preto/níquel mate

€ 129

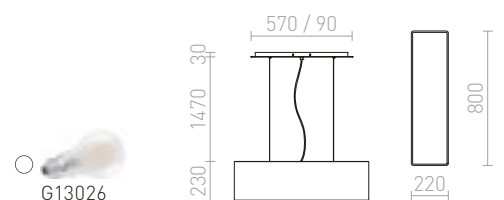



JAMAICA

Abajur trançado de material natural com formato cónico.

JAMAICA 34 SUSPENSO

230 V E27 15 W

R13397 natural

€ 78

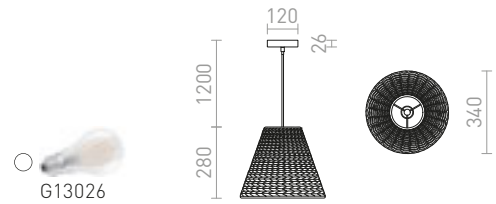

POLLOCK

Candeeiro têxtil suspenso com difusor embutido cinzento.

POLLOCK SUSPENSO

230 V E27 28 W

R13280 branco/cinzeno claro

€ 68

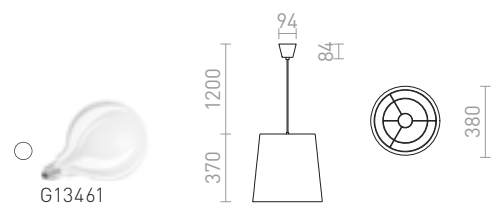



VESCO

Luminária suspensa com abajur metálico envernizado.

VESCO SUSPENSO

230 V E27 42 W

R10536 preto

€ 120 %

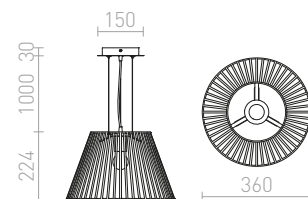

BUCKY

Candeeiro suspenso de metal com textura martelada.

BUCKY 40 SUSPENSO

230 V E27 28 W

R13360 branco/cinza/metal

€ 129 %

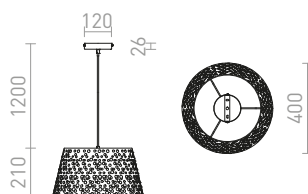





ESPLANADE

Candeeiro suspenso com abajur têxtil duplo.

ESPLANADE SUSPENSO

230 V E27 42 W

R12483 preto transparente/branco/cromo

€ 360

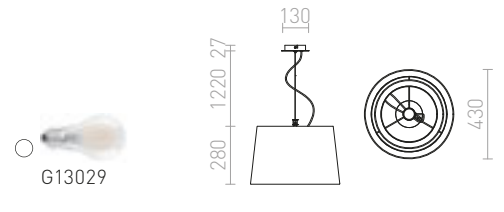

CHOUPELLE

Luminária suspensa em tecido com acessório em madeira para fonte de luz LED com casquilho E27.

CHOUPELLE SUSPENSO

230 V E27 15 W

R13650 cinzento escuro/têxtil/madeira

€ 120

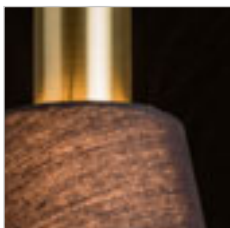
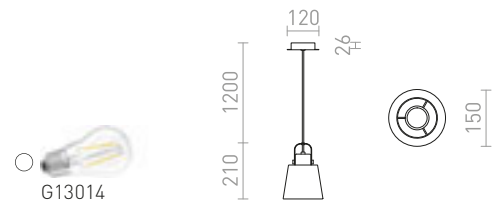

ICAR

Candeeiro suspenso minimalista com abajur têxtil.

ICAR SUSPENSO

230 V E27 15 W

R12418 preto/ouro

€ 98





TUTTI

Candeeiro suspenso com abajur cónico com luz descendente para fontes de luz E27.

TUTTI SUSPENSO

230 V E27 15 W

R13289 laranja/cerâmica

€ 48 %

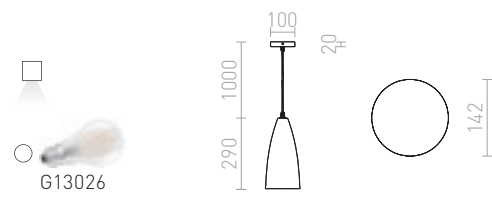

FRUTTI

Candeeiro suspenso para fontes de luz E27.

FRUTTI SUSPENSO

230 V E27 28 W

R13290 verde/cerâmica

€ 38 →

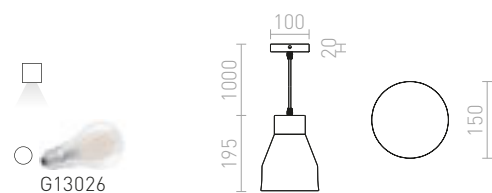



NANCY

Candeeiro suspenso com uma base e três abajures de tecido, para três fontes de luz E14.

NANCY III SUSPENSO

230 V E14 3x11 W

R13345 branco/vermelho

€ 58

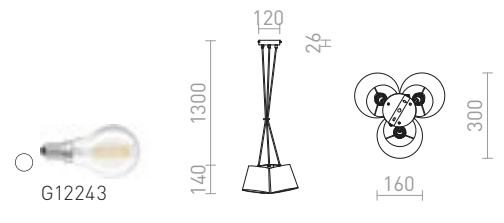

ESME

Candeeiro suspenso com abajur cônico oblongo branco e o interior cor de laranja.

ESME 76 SUSPENSO

230 V E27 28 W

R13276 branco/laranja

€ 68

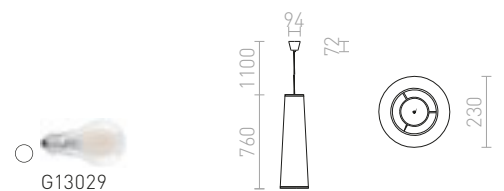



ELLA

Luminária suspensa de gesso para fonte LED com casquilho E27. Base do teto em metal lacado a branco. A luminária pode ser pintada com tintas para interiores.

ELLA SUSPENSO
230 V LED E27 15 W

R13788 gesso

€ 120 **NEW**

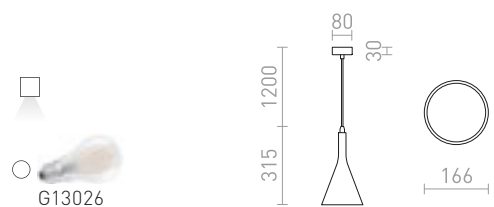



FLORIDA

Candeeiro suspenso de cerâmica texturada para fontes de luz E27.

FLORIDA SUSPENSO

230 V E27 28 W

R13298 cerâmica

€ 120

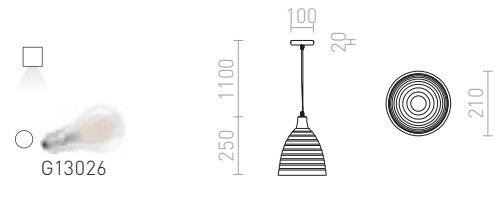

RADICAL

Candeeiro suspenso em cimento maciço com ligação de cabo e cabo independente para fonte de luz E27.

RADICAL SUSPENSO

230 V E27 28 W

R12416 cimento

€ 178

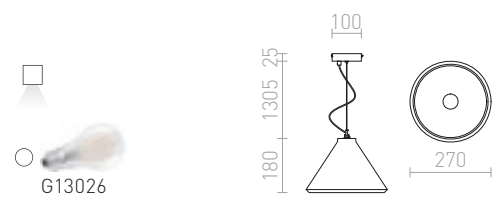

HEIDI

Luminária cônica em cimento suspensa com tampa em madeira para fonte de luz com casquilho E27.

HEIDI SUSPENSO

230 V E27 28 W

R12380 cimento/madeira

€ 88

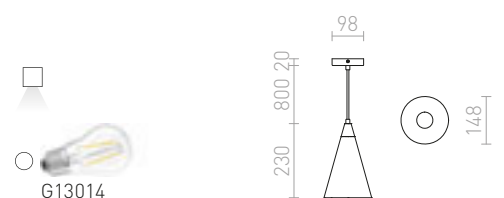



ILUSIA

Luminária suspensa com cortina de arame e cabo têxtil para uso com uma fonte de luz E27 adequada.

ILUSIA SUSPENSO

230 V E27 42 W

R13892 preto

€ 68 **NEW**

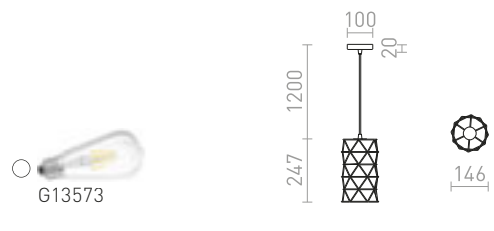

BURTON

Luminária de cimento suspenso com abajur e arames metálicos para fontes de luz E27.

BURTON SUSPENSO

230 V E27 42 W

R12931 cimento

€ 120





CAMINO

Candeeiro suspenso, de forma cilíndrica para fontes de luz E27. Cada base tem o seu acabamento exclusivo.

CAMINO SUSPENSO

230 V E27 28 W

R13296 terrazzo decor

€ 88

R13297 cimento

€ 88

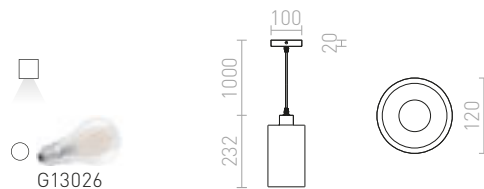



BELLINI

Luminária suspensa de vidro com acessórios lacados para fonte de luz LED com casquilho E14.

BELLINI L E14 SUSPENSO

230 V E14 15 W

R13658 branco/vidro transparente

€ 198

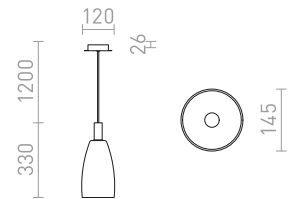

BELLINI

Luminária LED em vidro com design suspenso. Adequado para iluminar bares e ilhas de cozinha.

BELLINI M LED SUSPENSO

230 V LED 5 W $\angle 30^\circ$ 3000 K 475 lm Ra 80

R13652 preto/vidro de cor fumo

€ 215

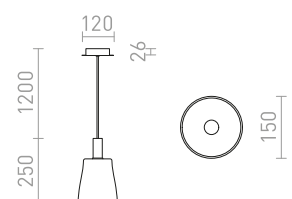



AZRIA

Candeeiro suspenso elegante com vidro texturado e acessórios cromados.

AZRIA SUSPENSO

230 V G9 25 W

R12056 vidro de cor fumo

€ 78 %



G13037

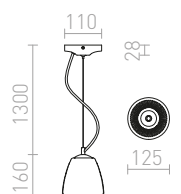

CORONA

Luminária suspenso com vidro sólido texturado. O vidro é cromado nos dois lados. Quando acesa, a fonte de luz é parcialmente visível.

CORONA SUSPENSO

230 V E27 42 W

R12055 vidro cromado

€ 215 %



G13461

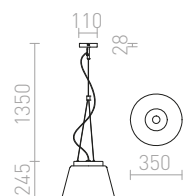



DORA

Luminária suspensa elegante de vidro transparente para fonte de luz de design com casquilho E27.

DORA SUSPENSO

230 V E27 28 W

R12417 vidro transparente/cromo

€ 88 %

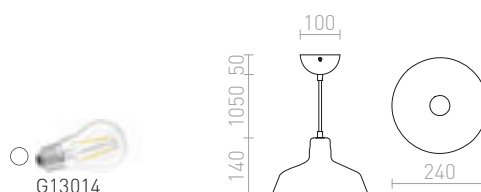

PULIRE

Candeeiro suspenso retro feito em vidro tingido para fonte de luz com casquilho E14.

PULIRE CON SUSPENSO

230 V E14 28 W

R12663 vidro colorido opala/madeira/cromo

€ 120

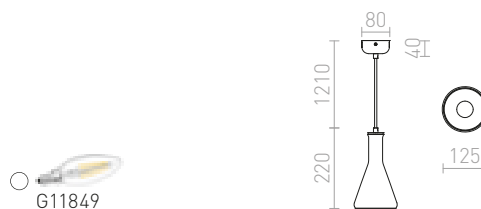

PULIRE RD SUSPENSO

230 V E14 28 W

R12664 vidro colorido opala/madeira/cromo

€ 120





COROA NEW 28

Luminária suspensa com abajur de vidro. Disponível em duas cores. Base de teto em cromo.

COROA NEW 28 SUSPENSO

230 V E27 53 W

R13824 vidro colorido opala/cromo

€ 215 **NEW**

R13825 preto/cromo

€ 238 **NEW**

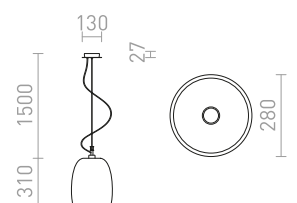



IP44

BOLLY

Luminária suspensa com vidro opalino e acessórios cromados. Adequado para ambientes húmidos.

BOLLY 17 SUSPENSO
230 V LED E27 15 W IP44

R13692 vidro colorido opala/cromo

€ 178



G13307

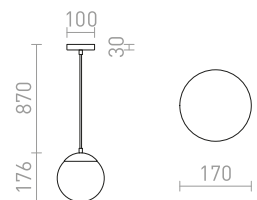



LUNA

Luminária suspensa em vidro opalino com acessórios cromados e cabo transparente.

LUNA 20 SUSPENSO

230 V LED E27 15 W

R13745 vidro colorido opala/cromo

€ 120 **NEW**

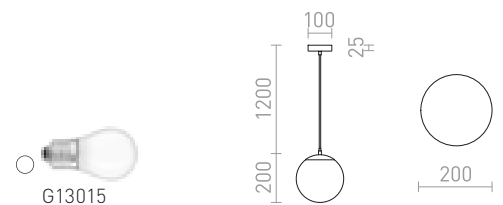

LUNA 25 SUSPENSO

230 V LED E27 15 W

R13746 vidro colorido opala/cromo

€ 178 **NEW**

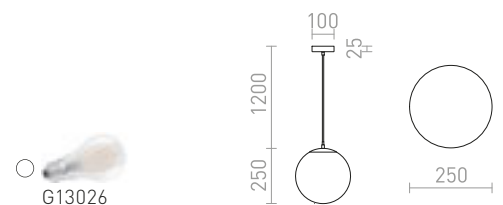

LUNA 30 SUSPENSO

230 V LED E27 15 W

R13747 vidro colorido opala/cromo

€ 220 **NEW**

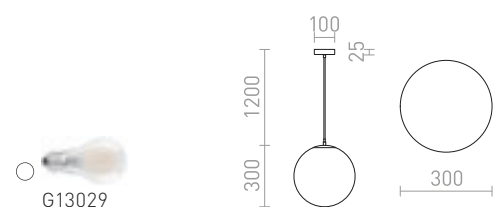



LUNEA

Luminária suspensa com esfera de vidro triplex em cor opala. O cabo de suspensão é separado do cabo de alimentação. Cabo transparente e detalhes cromados.

LUNEA 30 TRIPLEX SUSPENSO

230 V E27 70 W

R10478 vidro colorido opala

€ 178

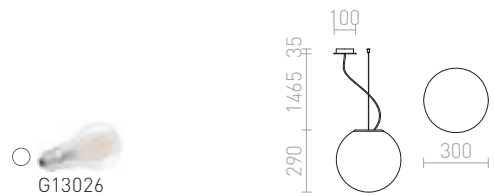

LUNEA 40 TRIPLEX SUSPENSO

230 V E27 70 W

R10479 vidro colorido opala

€ 320

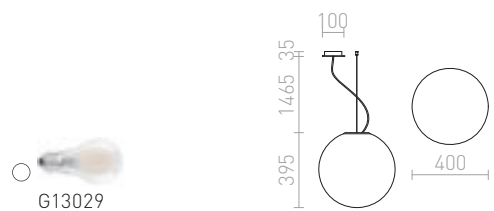

LUNEA 50 TRIPLEX SUSPENSO

230 V E27 100 W

R11715 vidro colorido opala

€ 460

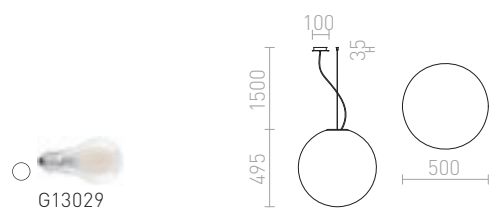







BABU NEW

Luminária suspensa com abajur de vidro, disponível em duas cores. Base de teto em cromo.

BABU NEW 22 SUSPENSO

230 V E27 53 W

R13826 vidro transparente/cromo

€ 178 NEW

R13827 vidro colorido opala/cromo

€ 150 NEW

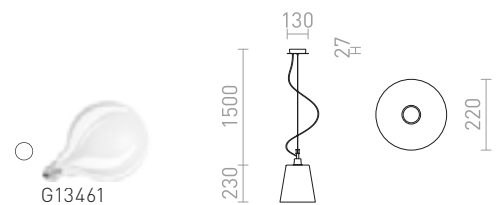

JULIETTA

Luminária suspensa decorativa de design em vidro cilíndrico opalino. Elementos de metal pintado, cabo têxtil preto.

JULIETTA 16 SUSPENSO

230 V E27 20 W

R13752 vidro colorido opala/preto

€ 129 NEW

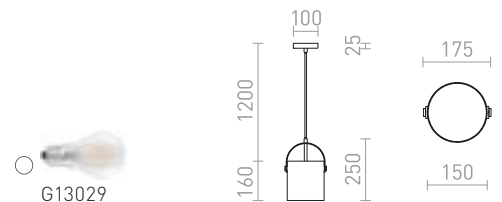

JULIETTA 31 SUSPENSO

230 V E27 20 W

R13753 vidro colorido opala/preto

€ 178 NEW

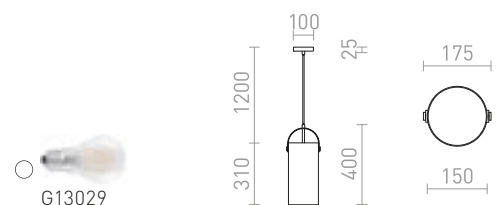



SANSSOUCI

Luminária suspensa com abajur de vidro. A luminária acesa é espelhada, e as fontes de luz são parcialmente visíveis quando a luz está acesa.

SANSSOUCI I SUSPENSO

230 V E27 42 W

R10511 vidro tingido de cobre

€ 120



SANSSOUCI I SUSPENSO

230 V E27 42 W

R10509 vidro cromado

€ 120



GARNISH

Luminária suspensa com base de cromo e abajur de vidro transparente. O abajur de vidro é fechado na parte inferior e pode acolher decorações apropriadas.

GARNISH SUSPENSO

230 V GU10 9 W

R11756 vidro transparente/cromo

€ 138









EIGHT

Luminária suspensa com abajur de vidro opalino com detalhes cromados.

EIGHT SUSPENSO

230 V E27 28 W

R10493 vidro colorido opala/cromo

€ 138

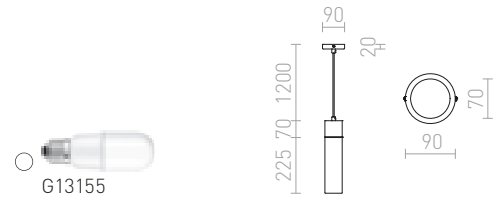

TOMBA

Luminária cilíndrica de vidro suspensa com acessórios cromados para três fontes de luz fluorescentes lineares.

TOMBA SUSPENSO

230 V G5 3x21 W

R10501 vidro colorido opala/cromo

€ 258

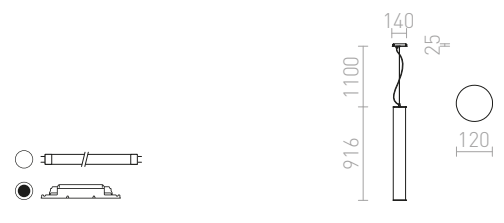

JACK

Luminária suspensa de gesso para fonte de luz com casquilho GU10. Base do teto em metal lacado a branco. A luminária pode ser pintada com tintas para interiores.

JACK RC SUSPENSO

230 V GU10 35 W

R11676 gesso

€ 68

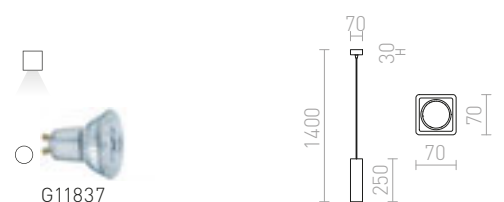





GIFT

Luminária suspensa com um abajur de vidro texturado transparente com acessórios cromados.

GIFT I SUSPENSO

230 V E14 42 W

R10510 vidro transparente/cromo

€ 88



G11849

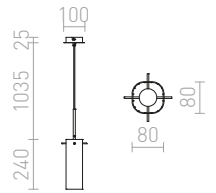

ESTRA

Luminária LED suspensa com foco de alumínio coberto com um abajur de vidro transparente.

ESTRA V SUSPENSO

230 V LED 5x5 W 3000 K 2000 lm Ra 81

R11678 branco/vidro transparente

€ 398

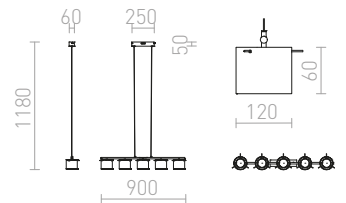
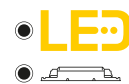

ESTRA I SUSPENSO

230 V LED 5 W 3000 K 400 lm Ra 81

R11679 branco/vidro transparente

€ 88

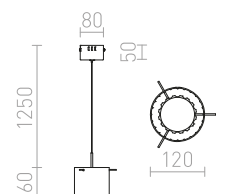



LIZ NEW

Luminária suspensa com abajur de vidro disponível em duas cores.

LIZ NEW SUSPENSO

230 V E27 28 W

R13822 vidro colorido opala/cromo

€ 88 NEW

R13823 preto/cromo

€ 98 NEW

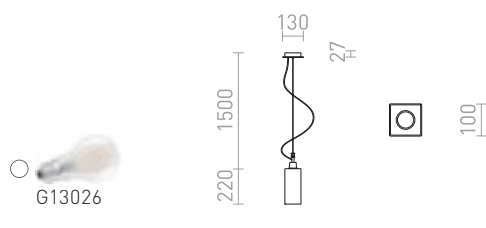

DADOS NEW

Luminária suspensa com abajur de vidro opala. Base de teto em cromo.

DADOS NEW SUSPENSO

230 V E27 28 W

R13821 vidro colorido opala/cromo

€ 88 NEW

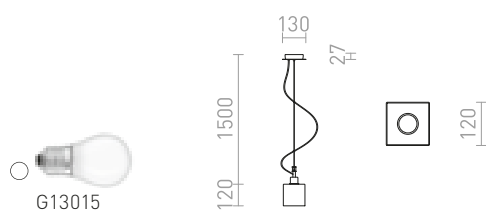





ASTERI

Luminária suspensa com abajur de vidro acetinado. A cobertura inferior é fixada com placa redonda cromada.

ASTERI SUSPENSO

230 V 2GX13 40 W

R10626 vidro acetinado/cromo

€ 98 %

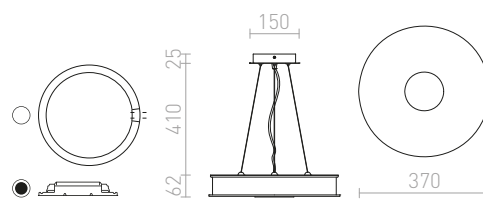

CASSABLANCA

Luminária para duas fontes de luz fluorescentes circulares T5. A cobertura inferior de vidro acetinado é fixada com parafuso de cabeça cromada. A lateral da luminária é feita de acrílato.

CASSABLANCA 40 SUSPENSO

230 V 2GX13 + 2GX13 22 W + 40 W

R10522 cromo

€ 129 %

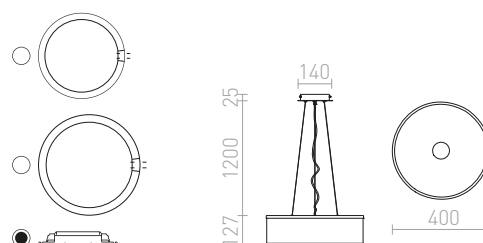





BROADWAY

Luminária suspensa com altura ajustável. Adequada para tetos sem tomadas. Com abajur têxtil estruturado. O interruptor está localizado no cabo de alimentação.

BROADWAY SUSPENSO AJUSTÁVEL

230 V E27 42 W

R11989 branco/cromo

€ 178 →

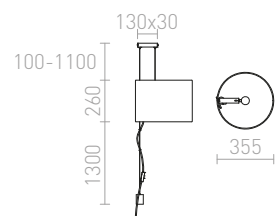



LEVITA

Candeeiro suspenso ajustável com abajur têxtil preto ou branco.

LEVITA SUSPENSO AJUSTÁVEL

230 V E27 42 W

R12477 branco/cromo

€ 480

R12478 preto/cromo

€ 480

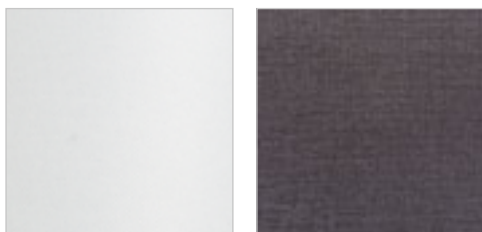

G13029

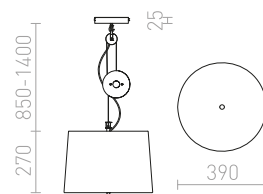



BROADWAY

Luminária de teto com braço ajustável no eixo do teto.
Abajur têxtil estruturado.

BROADWAY COM BRAÇO SUSPENSO

230 V E27 42 W

R11978 branco/cromo

€ 720 %

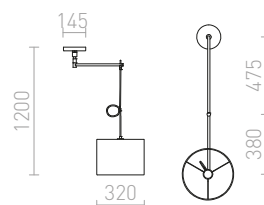
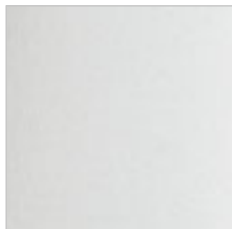

MADISON

Luminária de teto com braço ajustável e um abajur têxtil.

MADISON C TETO

230 V E27 42 W

R12479 branco/cromo

€ 520 →

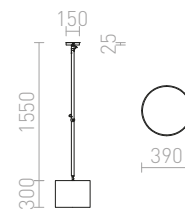





LOYD LED

Luminária de teto embutida LED com ajuste flexível multidirecional e abajur têxtil.

LOYD LED I TETO

230 V LED 4,5 W 3000 K 280 lm Ra 80

R12932 preto/níquel mate

€ 78 %

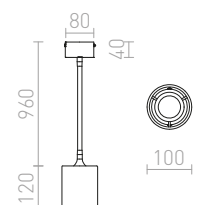



LOYD E27 I

Luminária de teto com um braço articulado coberto por forro de silicone, ajustável em todas as direções. Para uso com fontes de luz decorativas ou refletivas E27.

LOYD E27 I TETO

230 V E27 28 W

R12933 cinzento bege

€ 88 %

R12934 preto

€ 98



G13461

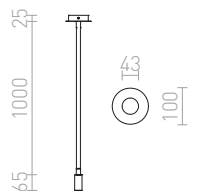

LOYD E27 III

Luminária de teto com três braços articulados cobertos por forro de silicone, ajustáveis em todas as direções. Para uso com fontes de luz decorativas ou refletivas E27.

LOYD E27 III TETO

230 V E27 3x28 W

R12935 preto

€ 215



G12246

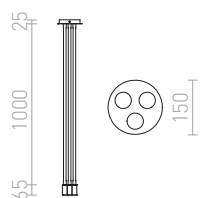

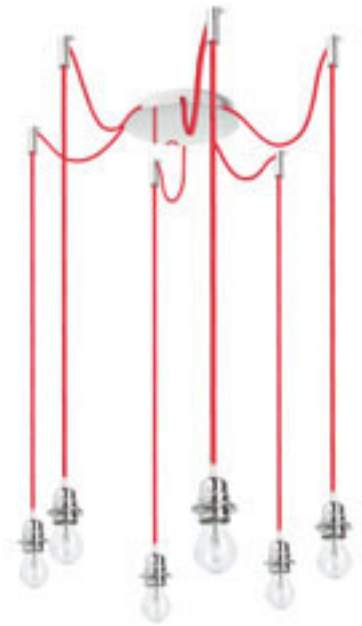

Outras versões do conjunto suspenso **KOMBIX** podem ser encontradas na categoria **Abajures e acessórios**.



CINDY

Luminária suspensa com base de teto central e seis dobradiças individuais com casquilho E27. As dobradiças estão equipadas com suportes de teto que podem ser colocados a uma distância individual da base. Comprimento total do cabo 2 m.

CINDY VI SUSPENSO

230 V E27 6x42 W

R12054 preto

€ 248

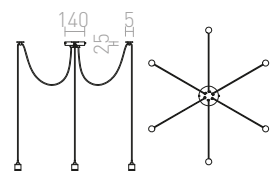



VIPER

Luminária de teto com design elegante, detalhes cromados, três focos de LED pretos e cabos têxteis vermelhos.

VIPER III TETO

230 V LED 3x3 W $\angle 60^\circ$ 3000 K 300 lm Ra 80

R12460 preto/cromo

€ 215 %

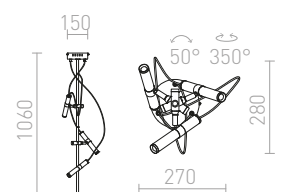





GIULIA

Candeeiro suspenso com abajur em metal lacado e cabo têxtil.

GIULIA 12 SUSPENSO

230 V E27 40 W

R13908 branco/cromo

€ 58 NEW

R13909 preto/castanho dourado/latão

€ 58 NEW

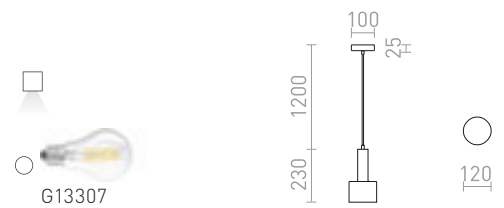

GIULIA 20 SUSPENSO

230 V E27 40 W

R13910 branco/cromo

€ 68 NEW

R13911 preto/castanho dourado/latão

€ 68 NEW

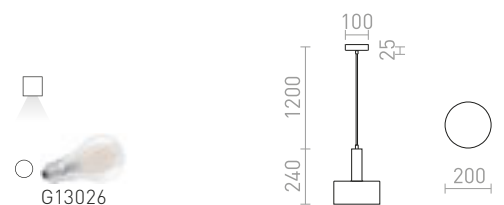

GIULIA 40 SUSPENSO

230 V E27 40 W

R13912 branco/cromo

€ 138 NEW

R13913 preto/castanho dourado/latão

€ 150 NEW

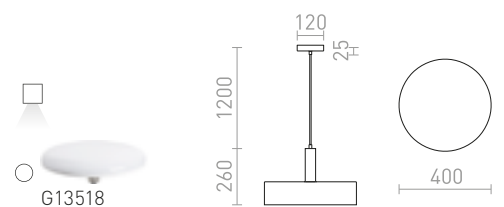



ASTON

Candeeiro suspenso de metal com cabo transparente, para fonte de luz com casquilho E27.

ASTON 28 SUSPENSO

230 V E27 42 W

R10515 alumínio escovado

€ 68 →

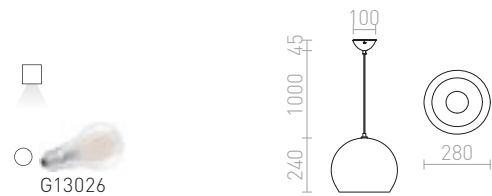

ASTON 30 SUSPENSO

230 V E27 42 W

R12394 cromo

€ 120 %

R12395 cobre

€ 120 %

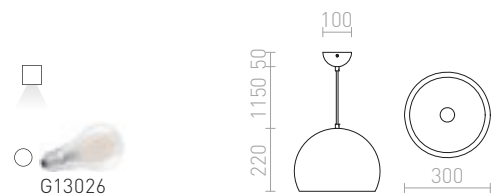



MARGO

Luminária suspensa em cromo com fonte de alimentação LED integrada, revestida por difusor acrílico. O difusor é moldado por anel de alumínio.

MARGO SUSPENSO

230 V LED 7 W 3000 K 700 lm Ra 80

R10578 cromo

€ 78

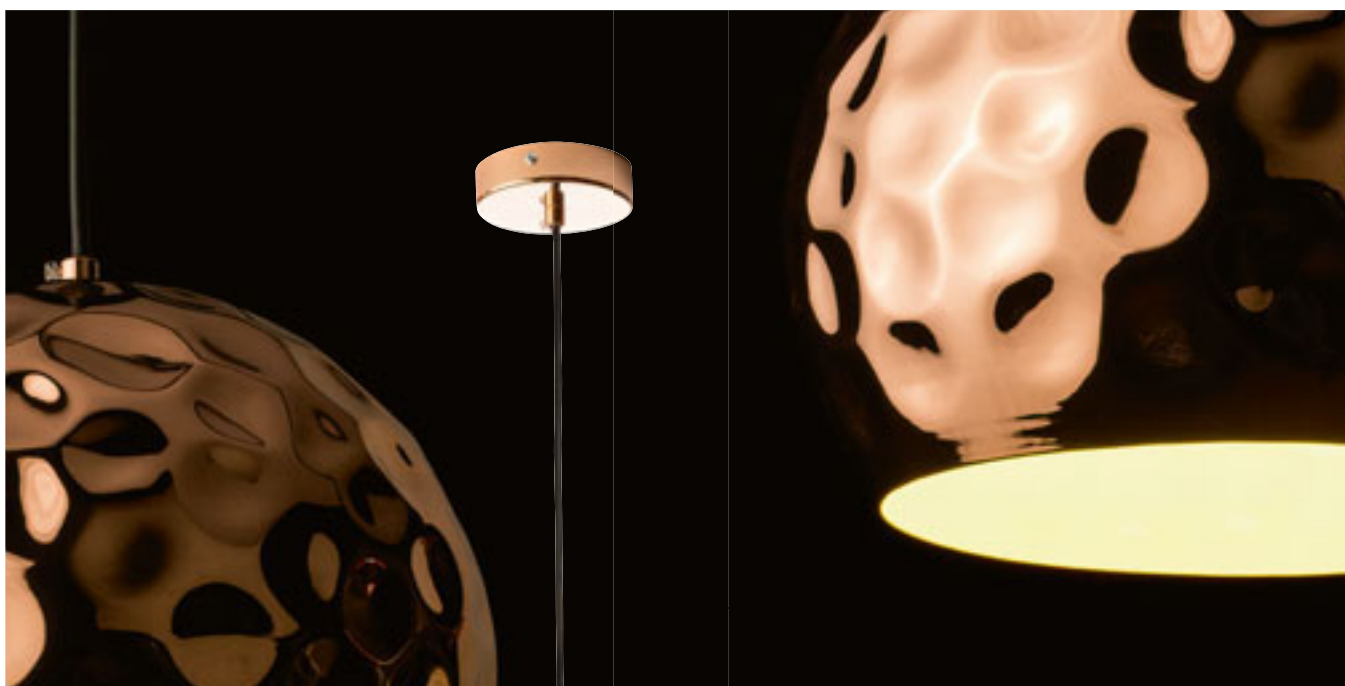
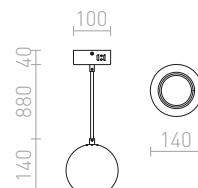

BLONDIE

Candeeiro suspenso com abajur metálico texturado. O exterior do abajur é em cobre, o interior é lacado a branco. Inclui cabo de PVC preto e copo de cobre.

BLONDIE 25 SUSPENSO

230 V E27 42 W

R12057 cobre

€ 198



G13461

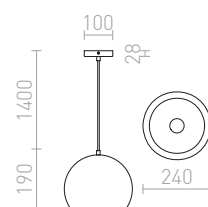





SINTRA

Candeeiro suspenso com abajur de metal cromado, disponível em dois tamanhos.

SINTRA 30 SUSPENSO

230 V E27 42 W

R11698 cromo

€ 68 %

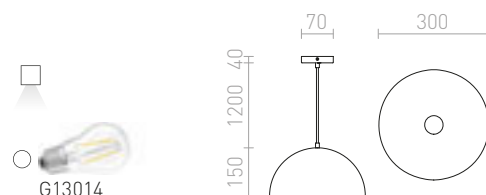

SINTRA 40 SUSPENSO

230 V E27 42 W

R11699 cromo

€ 138 %

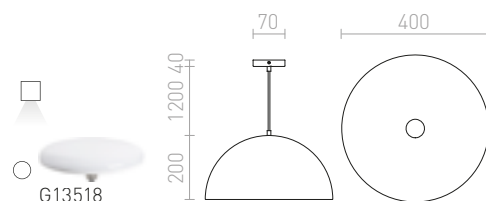

MONROE

Luminária suspensa com abajur metálico, disponível em três tamanhos.

MONROE 30 SUSPENSO

230 V E27 42 W

R11700 mate preto/branco

€ 158

R12396 cobre

€ 120 %

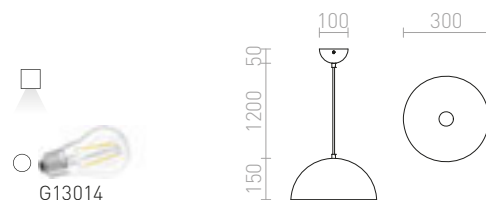

MONROE 40 SUSPENSO

230 V E27 42 W

R11701 mate preto/branco

€ 238

R11707 branco brilhante/branco

€ 229

R12397 cobre

€ 158 %

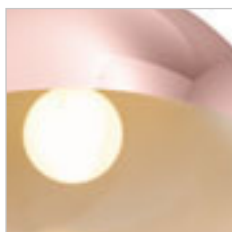
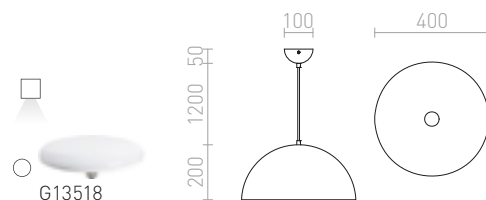





GOLDIE

Luminária de metal suspensa, disponível em três cores.

GOLDIE 36 SUSPENSO

230 V E27 42 W

R11687 cromo

€ 120 %

R11688 preto/branco

€ 178 %

R11689 branco/branco

€ 88 %

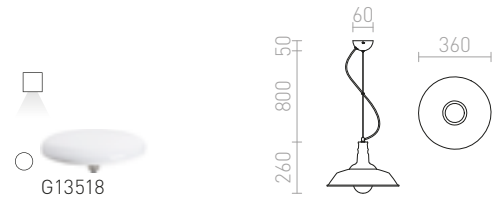

GOLDIE 46 SUSPENSO

230 V E27 42 W

R11690 preto/branco

€ 258

R11691 branco/branco

€ 248

R11692 cromo

€ 158

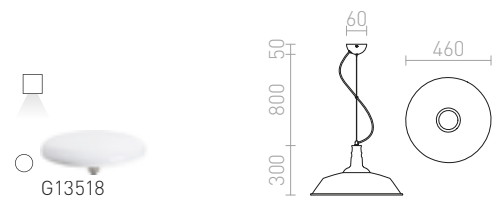

MERYLYN

Luminária suspensa cônica de metal para casquilho E27.

MERYLYN 34 SUSPENSO

230 V E27 28 W

R12445 preto/branco

€ 138 %

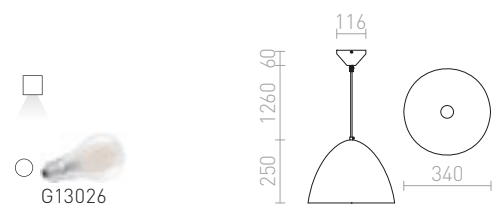

MERYLYN 48 SUSPENSO

230 V E27 42 W

R12446 alumínio penteado/laca dourada

€ 158

R12447 preto/branco

€ 158

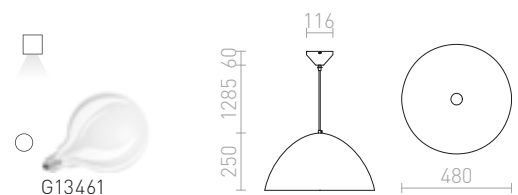



CARISSIMA

Candeeiro suspenso com abajur de metal lacado ou cromado. A parte interior do abajur tem um design dourado ou cinza prateado.

CARISSIMA 25 SUSPENSO

230 V E27 28 W

R11765 cromo

€ 68

%

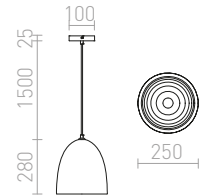

CARISSIMA 40 SUSPENSO

230 V E27 42 W

R11766 mate preto/ouro

€ 248

R13048 mate branco/cinza prata

€ 248

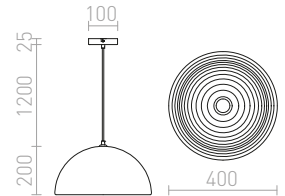

BABADES

Luminária suspensa com abajur e base de teto em cromo ou níquel mate. Inclui um cabo têxtil preto.

BABADES IV SUSPENSO

230 V GU10 4x35 W

R12083 cromo

€ 215

%

R12084 níquel mate

€ 215

%

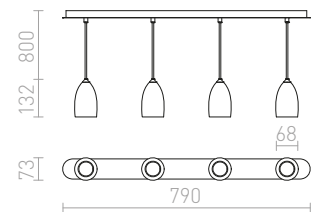

BABADES I SUSPENSO

230 V GU10 35 W

R12081 cromo

€ 58

R12082 níquel mate

€ 58

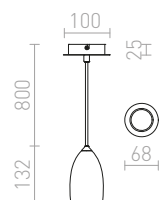





RIGA

Luz de teto com LED integrado, disponível em quatro cores

RIGA 28 SUSPENSO

230 V LED 6 W $\angle 38^\circ$ 3000 K 570 lm Ra 80

R12456 cromo

€ 98 %

R12457 cobre

€ 98 %

R12458 branco

€ 98

R12459 preto

€ 98

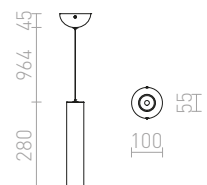
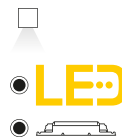



MAVRO

Elegante foco LED suspenso cilíndrico adequado sobre balcões de bar e ilhas de cozinha. TRIAC com regulação da intensidade da luz.

MAVRO DIMM SUSPENSO

230 V LED 12 W $\angle 38^\circ$ 3000 K 1020 lm Ra 80

R13182 branco

€ 178

R13183 ouro

€ 178

R13184 preto/ouro

€ 178

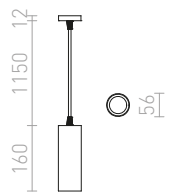

MAVRO

Elegante foco LED tubular suspenso adequado sobre balcões de bar e ilhas de cozinha.

MAVRO SUSPENSO

230 V LED 12 W $\angle 38^\circ$ 3000 K 1020 lm Ra 80

R12990 branco

€ 120

R12991 ouro

€ 120

R12992 preto/ouro

€ 120

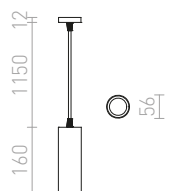
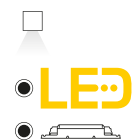



BOGARD

Luminária LED cilíndrica suspensa. A luminária pode ser ampliada óticamente usando R12495 e R12496.

BOGARD SUSPENSO

230 V LED 5 W $\angle 40^\circ$ 3000 K 350 lm Ra 80

R12493 mate preto

€ 98

R12494 níquel mate

€ 78

%

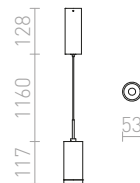
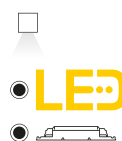

BOGARD

Acessório para focos suspensos Bogard R12493 e R12494.

BOGARD

EXTENSOR PARA SUSPENSOS

R12495 mate preto

€ 15.50

R12496 níquel mate

€ 15.50

%

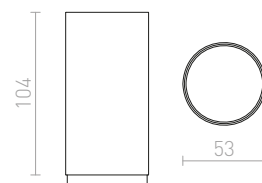

BELENOS

Foco suspenso cilíndrico minimalista para fontes de luz GU10 sobre base redonda. As molas ligadas ao casquilho permitem o uso de fontes de luz de vários comprimentos.

BELENOS SUSPENSO

230 V LED GU10 9 W

R13365 branco

€ 58

R13366 preto

€ 58

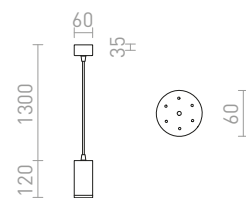



OPTIMUS

Luminária cilíndrica suspensa com possibilidade de ajuste do cone de luz mediante sistema de zoom de 10-50°. A luminária é adequada para fontes de luz LED com casquilho GU10. Use fontes de luz com um ângulo de feixe de 120° na luminária para evitar sombras indesejadas.

OPTIMUS SUSPENSO

230 V LED GU10 9 W \angle 10-50°

R13777 branco

€ 58 NEW

R13778 preto

€ 58 NEW

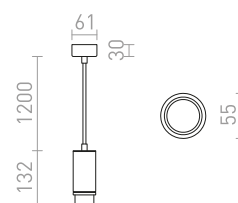



MEZZO

Plafon de teto com fonte de luz LED embutida e moldura de alumínio lacada. O equipamento é fornecido com um difusor de luz em policarbonato fosco. Com o kit de suspensão (R13330 ou R13331), o plafon pode ser instalado como suspenso. Regulação da intensidade da luz TRIAC.

MEZZO 80 DIMM TETO

230 V LED 100 W 3000 K 6400 lm Ra 80

R13334 branco

€ 950

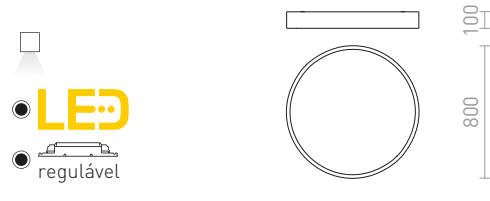

MEZZO

Conjunto suspenso adequado para a série MEZZO.

MEZZO 80 CONJUNTO SUSPENSO

230 V

R13335 branco

€ 120

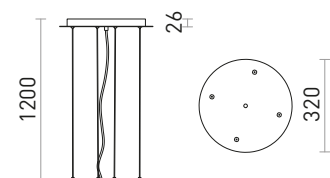



MEZZO

Plafon de teto com fonte de luz LED embutida e moldura de alumínio lacada. O equipamento é fornecido com um difusor de luz em policarbonato fosco. Com o kit de suspensão (R13330 ou R13331), o plafon pode ser instalado como suspenso. Regulação da intensidade da luz TRIAC.

MEZZO 40 DIMM TETO

230 V LED 30 W 3000 K 1800 lm Ra 80

R13328 branco

€ 268

R13329 preto

€ 290

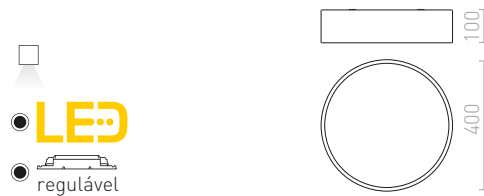

MEZZO 60 DIMM TETO

230 V LED 60 W 3000 K 3700 lm Ra 80

R13332 branco

€ 560

R13333 preto

€ 560

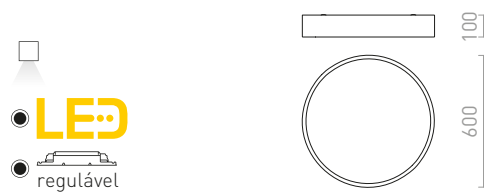

MEZZO

Conjunto suspenso adequado para a série MEZZO.

MEZZO 40/60 CONJUNTO SUSPENSO

230 V

R13330 branco

€ 58

R13331 preto

€ 58

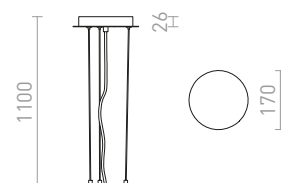





MONETA

Luminária LED suspenso com um design muito elegante. Inclui um difusor de policarbonato fosco. Regulação da intensidade da luz TRIAC.

MONETA DIMM SUSPENSO

230 V LED 36 W 3000 K 2500 lm Ra 80

R10581 branco

€ 320 %

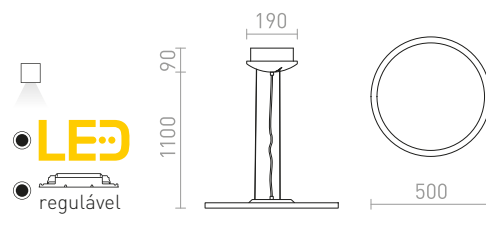

MENSA

Plafon LED suspenso com moldura em alumínio escovado. Inclui um difusor de acrílico fosco.

MENSA R 60 SUSPENSO

230 V LED 52 W 3000 K 3300 lm Ra 80

R12118 alumínio escovado

€ 398 %

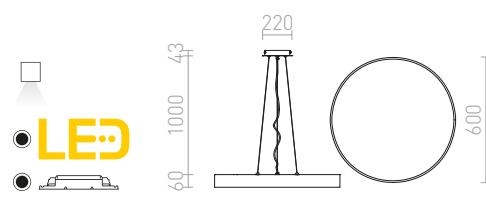

LARISA

Plafon suspenso com LED e moldura minimalista.

LARISA R 30 SUSPENSO

230 V LED 30 W 3000 K 2400 lm Ra 80

R12846 branco

€ 129 %

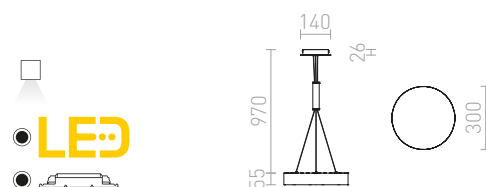



MESA

Luminária LED suspensa com moldura em alumínio lacado ou escovado. Inclui um difusor de acrílico fosco.

MESA SQ 48 SUSPENSO

230 V LED 56 W 3000 K 3530 lm Ra 80

R11291 branco

€ 229

%

R11292 alumínio escovado

€ 248

%

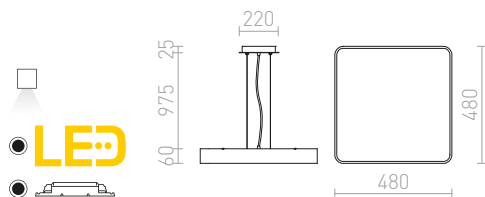



MENSA

Luminária LED suspensa com moldura de alumínio lacada a branco. Inclui difusor em acrílico fosco.

MENSA RC SUSPENSO

230 V LED 36 W 3000 K 2300 lm Ra 80

R10584 branco

€ 178 %

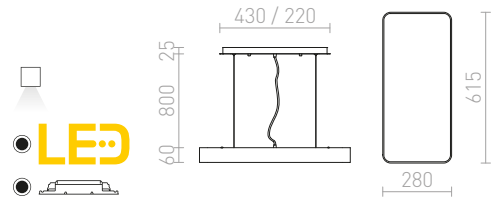

LARISA

Plafon suspensó LED quadrado com moldura minimalista.

LARISA SQ 30 SUSPENSO

230 V LED 30 W 3000 K 2400 lm Ra 80

R12852 branco

€ 120 %

R12853 preto

€ 120 %

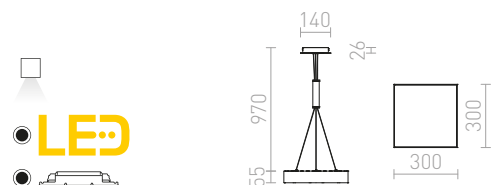





STRUCTURAL

Luminária suspensa LED em perfil de alumínio, design elegante em alumínio natural ou lacado a branco com difusor PMMA opalino com luz embutida, cabo transparente de três núcleos.

STRUCTURAL LED 20x20 SUSPENSO

230 V LED 12 W 3000 K Ra 80

R13709 alumínio escovado

€ 138

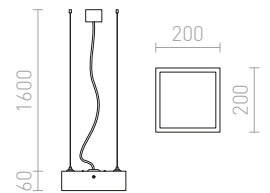
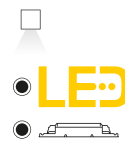

STRUCTURAL LED 40x40 SUSPENSO

230 V LED 36 W 3000 K Ra 80

R13710 branco

€ 278

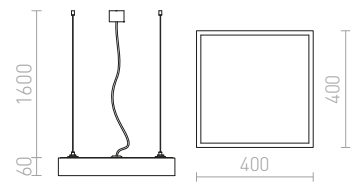
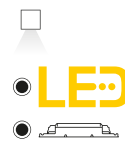

STRUCTURAL LED 55x55 SUSPENSO

230 V LED 48 W 3000 K Ra 80

R13713 branco

€ 198

R13714 alumínio escovado

€ 248

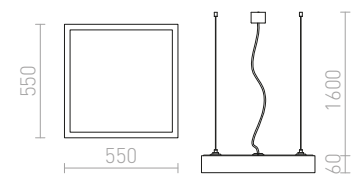
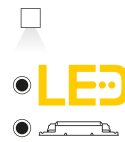



BERLINO

Luminária suspensa linear com tecnologia LED.
O difusor é de acrílico fosco.

BERLINO SUSPENSO

230 V LED 24 W 3000 K 1680 lm Ra 80

R10637 preto

€ 178 %

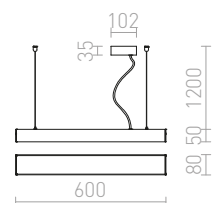
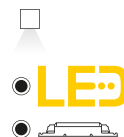



PESANTE

Luminária suspensa linear com LED integrado adequada para interiores modernos.

PESANTE 35 SUSPENSO

230 V LED 40 W 3000 K 3340 lm Ra 80

R12718 alumínio anodizado

€ 220

R12719 preto

€ 215

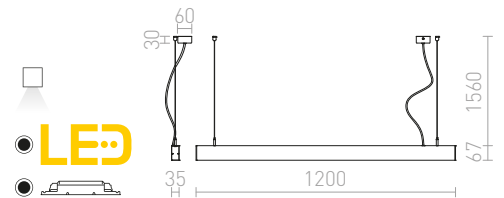

PESANTE 75 SUSPENSO

230 V LED 40 W 3000 K 4200 lm Ra 80

R12720 alumínio anodizado

€ 278

R12721 preto

€ 320

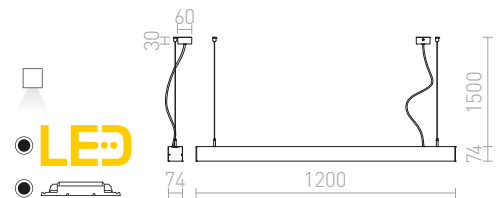

INDIGO

Luminária LED suspensa linear adequada para mesas e balcões.

INDIGO SUSPENSO

230 V LED 18 W 3000 K 1580 lm Ra 80

R12676 alumínio escovado

€ 215

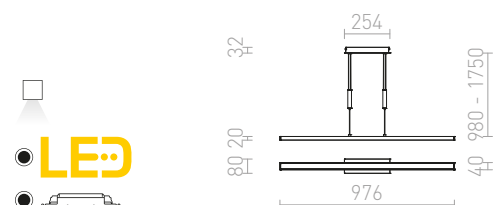



IP65

TRIDENT PRO

Luminária industrial linear LED para montagem em teto ou suspenso com kit G13672. Alto desempenho e proteção IP65. Fornecido sem kit de suspensão e cabo de alimentação. Possibilidade de ligação entre luminárias em série.

TRIDENT PRO 120 CORPO

230 V LED 40 W 4000 K 5200 lm Ra 80 IP65

G13670 cinzento/acrílico fosco

€ 68

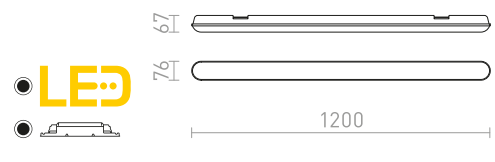

TRIDENT PRO 150 CORPO

230 V LED 60 W 4000 K 7800 lm Ra 80 IP65

G13671 cinzento/acrílico fosco

€ 88

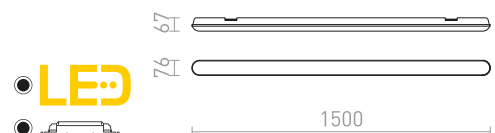



TRIDENT PRO

Conjunto para pendurar luminárias Trident.

TRIDENT PRO CONJUNTO SUSPENSO 2 PÇS

613672 preto

€ 4

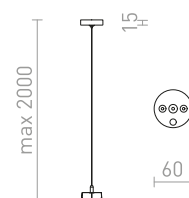

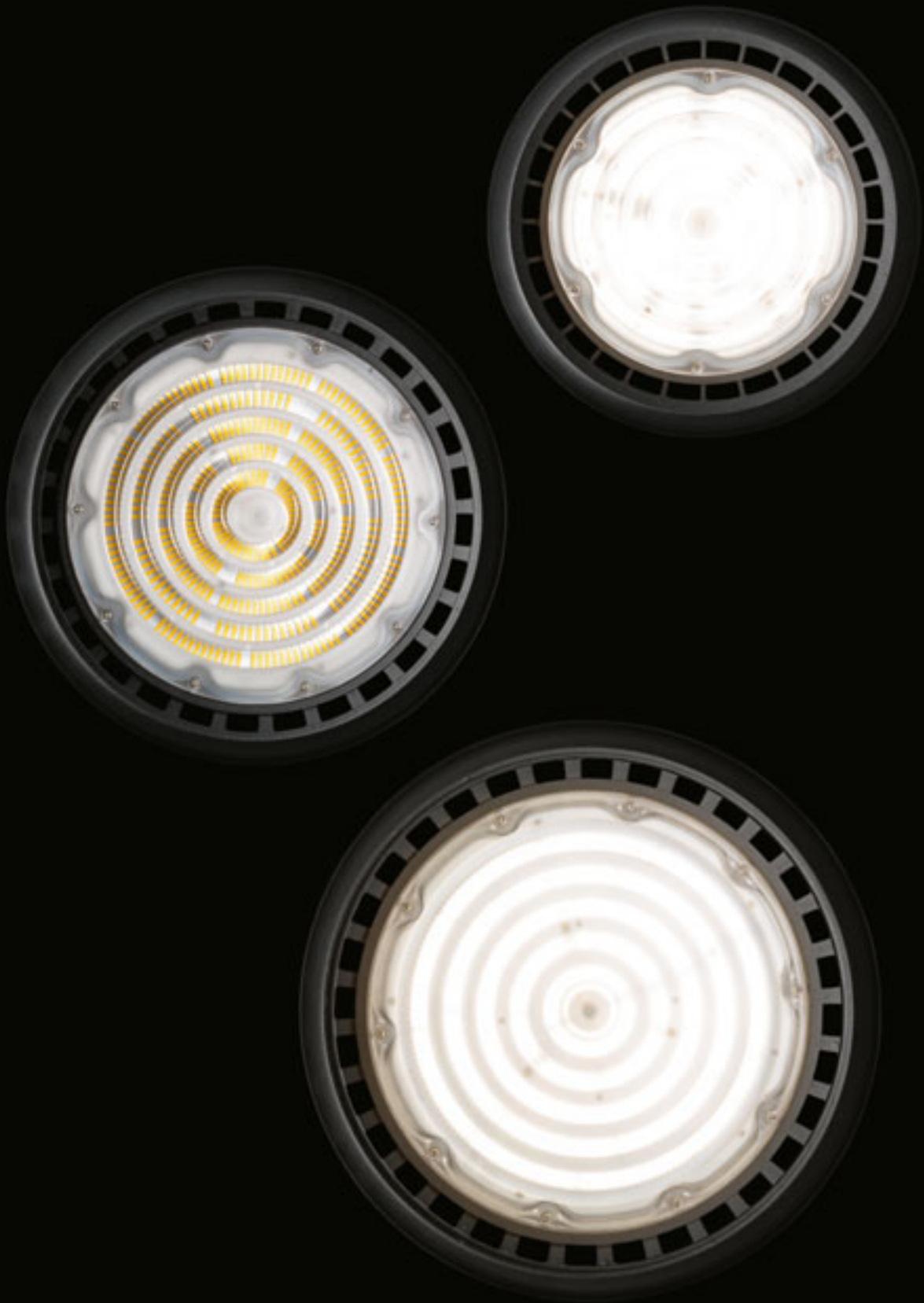

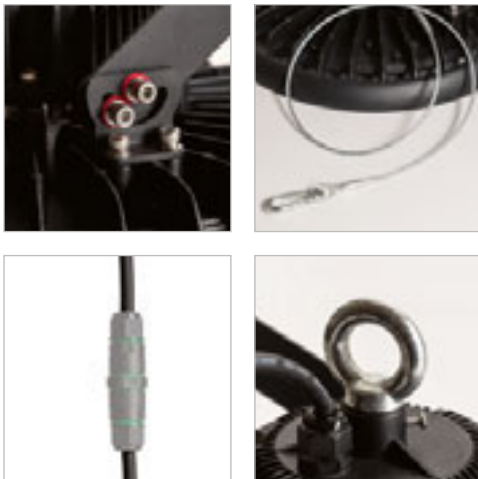

MEGALOS PRO

Refletor industrial LED de alta potência para suspensão. Fornecido com cabo de segurança (0,5 m), olhal de suspensão e cabo de alimentação com 0,2 m de comprimento. Recomendamos o uso de IP BOX G12984 para ligar ao seu cabo de alimentação.

MEGALOS PRO 26 CORPO

230 V LED 100 W $\angle 90^\circ$ 4000 K 16000 lm Ra 80 IP65

G13749 preto

€ 98

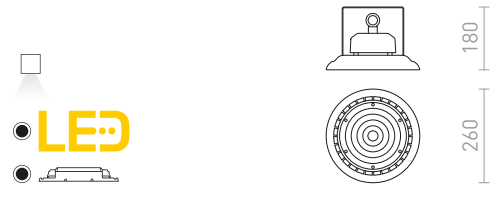

MEGALOS PRO 30 CORPO

230 V LED 150 W $\angle 90^\circ$ 4000 K 24000 lm Ra 80 IP65

G13750 preto

€ 120

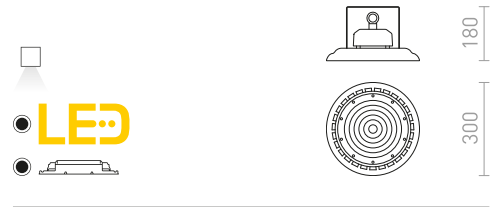

MEGALOS PRO 35 CORPO

230 V LED 200 W $\angle 90^\circ$ 4000 K 32000 lm Ra 80 IP65

G13751 preto

€ 158

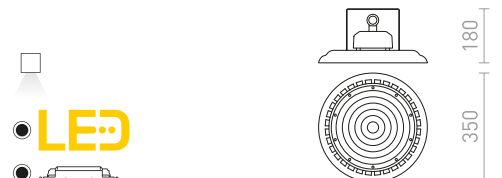



CANDEEIROS DE TETO

CASA DE BANHO	104-125
GESSO	126-131
AJUSTÁVEL	132-135
DESCENDENTE	136-153
DECORATIVO	154-159
TÉCNICO	160-191

CANDEEIROS DE TETO

CASA DE BANHO



GRANDE LED 25
104-105



GRANDE LED 35
104-105



CIRA 29
106-107

104-125



CIRA LED 23
106-107



CIRA LED 35
106-107



GORRA
108-109



BARRY
108-109



AWE 23
108-109



AWE 33
108-109



ZARA LED 26
110-111



SARA LED 26
110-111



SARA LED 36
110-111



SASSARI
110-111



VENICE 23
112-113



VENICE LED 30
112-113



ARANA R 17
112-113



ARANA R 27
112-113



BOLLY 17
114-115



BOLLY 26
114-115



MERINGUE 11
114-115



MERINGUE 16
114-115



ESICA CYL
116-117



ESICA SQ
116-117



EIGHT
116-117



ORIN R
118-119



ORIN SQ
118-119



SENZA R
118-119



SENZA SQ
118-119



LOLA 88
120-121



SAMMY
120-121



EILEEN
120-121



KIM
120-121



MERIDO
122-123



LIZZI
122-123



RODGE
122-123



DEZA
122-123



MERANO LED 30
124-125



MERANO LED 35
124-125



KATHARIS SQ 28
124-125



SPECTACLE
124-125



BONO
124-125

CANDEEIROS DE TETO GESSO



GINA S 17
126-127



GINA
126-127



GINA III
126-127

126-131



COLIN
126-127



JACK SQ S 17
128-129



JACK SQ
128-129



JACK III
128-129



VOLCA
130-131



COLES
130-131



COLES SQ
130-131



ATIKA
130-131

CANDEEIROS DE TETO AJUSTÁVEL



BOGARD
132-133



BOGARD TWIN
132-133



BELENOS
132-133

132-135



CONDU
134-135



SNAZZY
134-135



PIXIE
134-135



DARIO
134-135

CANDEEIROS DE TETO DESCENDENTE

136-153



RIGA 18
136-137



RIGA 38
136-137



KELLY LED
136-137



CONNOR
136-137



VADE R
138-139



TUBA
138-139



CANTO
138-139



PIXIE
140-141



MAYO R
140-141



MEA
140-141



MOMA
142-143



MOMA
142-143



MOCCA
142-143



MANTOVA I
144-145



MANTOVA II
144-145



MILANO I
144-145



MILANO II
144-145



GAYA
144-145



ENKI EDG I
146-147



ENKI EDG II
146-147



AGATE I
146-147



AGATE II
146-147



CUBO
146-147



BERIT I
148-149



BERIT II
148-149



MAYO SQ
148-149



MEA
148-149



EX 111
150-151



JAMES I
150-151



JAMES II
150-151



MARVEL
152-153



MARVEL II
152-153



EX GU10
152-153

CANDEIROS DE TETO DECORATIVO



TACO
154-155



OTIS 50
154-155



OTIS 60
154-155

154-159



VENICE 23
156-157



VENICE LED 30
156-157



MARA
156-157



MELISA 25
158-159



MELISA 52
158-159



ARANA SQ
158-159

CANDEEIROS DE TETO TÉCNICO



MEZZO 40
160-161



MEZZO 60
160-161



MEZZO 80
160-161

160-191



LARISA R 12
162-163



LARISA R 22
162-163



LARISA R 30
162-163



LARISA R 40
162-163



LARISA R 12
164-165



LARISA R 22
164-165



LARISA R 30
164-165



HUE R 9
166-167



HUE R 17
166-167



HUE R 22
166-167



HUE R 9
168-169



HUE R 17
168-169



HUE R 22
168-169



MENSA R 40
170-171



MENSA R 80
170-171



ALLEGRO II 43
170-171



SOCORRO R 120
172-173



SOCORRO R 300
172-173



SLENDER SQ 12
172-173



SLENDER SQ 22
172-173



SLENDER R 12
172-173



LARISA SQ 17
174-175



LARISA SQ 22
174-175



LARISA SQ 30
174-175



LARISA SQ 40
174-175



LARISA SQ 17
176-177



LARISA SQ 22
176-177



LARISA SQ 30
176-177



MENSA SQ 40
178-179



MENSA SQ 48
178-179



MENSA SQ 80
178-179



STRUCTURAL LED 20x20
180-181



STRUCTURAL LED 40x40
180-181



STRUCTURAL LED 55x55
180-181



HUE SQ 9
182-183



HUE SQ 17
182-183



HUE SQ 22
182-183



HUE SQ 9
184-185



HUE SQ 17
184-185



HUE SQ 22
184-185



SEMPRE R 45
186-187



SEMPRE R 55
186-187



SEMPRE SQ 43
186-187



SEMPRE SQ 63
186-187



SEMPRE SQ 33
188-189



SEMPRE SQ 43
188-189



SEMPRE SQ 53
188-189



SEMPRE SQ 63
188-189



STRUCTURAL LED 60x15
190-191



RIVIER
190-191



TRIDENT PRO 120
190-191



TRIDENT PRO 150
190-191



IP44



IP44



GRANDE

Plafon de LED para casa de banho com vidro plano opalino em estrutura de metal.

GRANDE LED 25 TETO

230 V LED 12 W 3000 K 900 lm Ra 80 IP44

R13676 vidro colorido opala/cromo

€ 178

R13677 vidro colorido opala/preto

€ 178

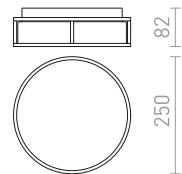

GRANDE LED 35 TETO

230 V LED 24 W 3000 K 1700 lm Ra 80 IP44

R13678 vidro colorido opala/cromo

€ 320

R13679 vidro colorido opala/preto

€ 278

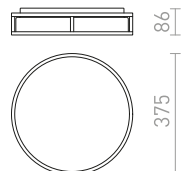





IP44

CIRA

Plafon LED com vidro plano opalino em estrutura de metal. Adequado para ambientes húmidos.

CIRA 29 TETO

230 V LED 20 W 3000 K 776 lm Ra 80 IP44

R12195 cromo

€ 178

%

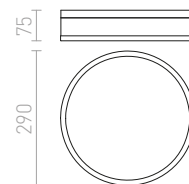

IP44

CIRA

Plafon LED com vidro plano opalino em estrutura de metal. Adequado para ambientes húmidos.

CIRA LED 23 TETO

230 V LED 12 W 3000 K 900 lm Ra 80 IP44

R13680 vidro colorido opala/preto

€ 129

R13742 vidro colorido opala/cromo

€ 150

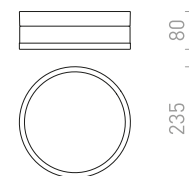

IP44

CIRA LED 35 TETO

230 V LED 24 W 3000 K 1700 lm Ra 80 IP44

R13681 vidro colorido opala/cromo

€ 278

R13754 vidro colorido opala/preto

€ 258

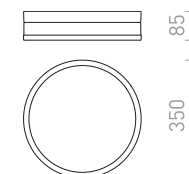





IP44

GORRA

Plafon para ambientes húmidos. O vidro opalino tem as seguintes dimensões Ø / A 24/3 cm.

GORRA TETO

230 V E14 2x40 W IP44

R10500 cromo

€ 88 %

R12048 níquel mate

€ 88 %

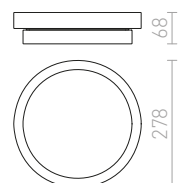



IP44

BARRY

Plafon circular com moldura de níquel mate para fonte de luz fluorescente circular com eficiência energética.

BARRY TETO

230 V 2GX13 22 W IP44

R10576 níquel mate

€ 48

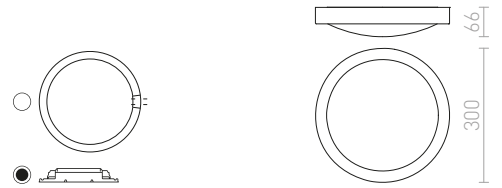

IP44



IP44

AWE

Plafon com LED integrado e abajur de vidro opalino. A base do teto é cromada ou níquel mate. Adequado para ambientes húmidos.

AWE 23 TETO

230 V LED 14 W 3000 K 580 lm Ra 80 IP44

R12196 níquel mate

€ 138

R12201 cromo

€ 138

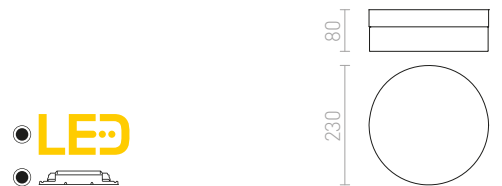

IP44

AWE 33 TETO

230 V LED 21 W 3000 K 948 lm Ra 80 IP44

R12197 níquel mate

€ 220

R12202 cromo

€ 220

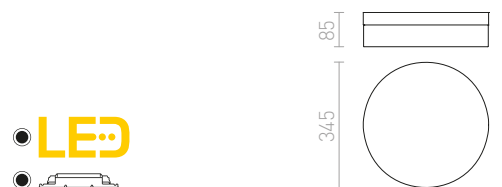



IP44

ZARA

Plafon LED de vidro opalino com base cromada, adequada para ambientes húmidos.

ZARA LED 26 TETO

230 V LED 12 W 3000 K 900 lm Ra 80 [IP44](#)

R13686 vidro colorido opala/cromo

€ 138

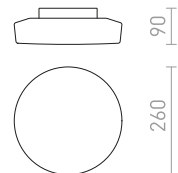

IP65

SASSARI

Plafon LED redondo para teto de casa de banho.

SASSARI TETO

230 V LED 24 W 3000 K 1900 lm Ra 80 [IP65](#)

R13642 branco/policarbonato/plástico

€ 120

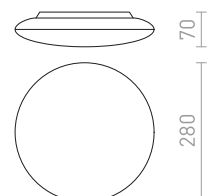



IP44



IP44

SARA

Plafon de LED em vidro opalino com base cromada, adequado para casas de banho.

SARA LED 26 TETO

230 V LED 12 W 3000 K 900 lm Ra 80 IP44

R13687 vidro colorido opala/cromo

€ 138

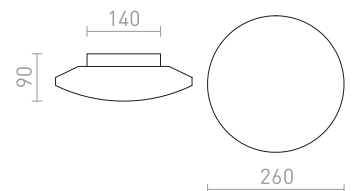

● LED



SARA LED 36 TETO

230 V LED 24 W 3000 K 1700 lm Ra 80 IP44

R13688 vidro colorido opala/cromo

€ 248

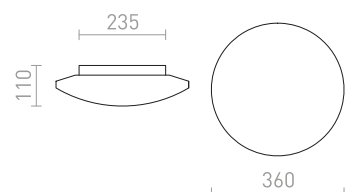

● LED





IP44

ARANA

Cilindro de teto em vidro opalino com base cromada, adequado para casas de banho.

ARANA R 17 TETO

230 V E27 15 W IP44

R13682 vidro colorido opala/cromo

€ 120



G13014



160



170



IP44

ARANA

Cilindro de teto em vidro opalino com base cromada, adequado para casas de banho.

ARANA R 27 TETO

230 V E27 20 W IP44

R13683 vidro colorido opala/cromo

€ 198

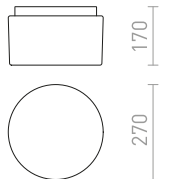

IP44

VENICE

Luminária de teto, combinação de opala no interior e vidro transparente no exterior sobre base cromada, para casquilho LED E27. Adequado para ambientes húmidos

VENICE 23 TETO

230 V E27 20 W IP44

R13684 vidro transparente/vidro colorido opala/cromo **€ 215**

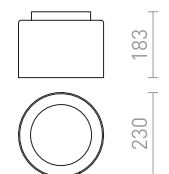

IP44

VENICE

Plafon LED, combinação de opala no interior e vidro transparente no exterior sobre base cromada. Adequado para ambientes húmidos.

VENICE LED 30 TETO

230 V LED 12 W 3000 K 900 lm Ra 80 IP44

R13685 vidro transparente/vidro colorido opala/cromo **€ 258**

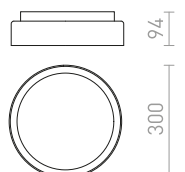





IP44



IP44



IP44

IP44



BOLLY

Candeeiro de teto em vidro opalino com base cromada. Adequado para casas de banho.

BOLLY 17 TETO

230 V E27 15 W IP44

R13693 vidro colorido opala/cromo

€ 158

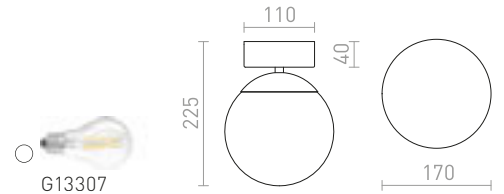

BOLLY 26 TETO

230 V E27 15 W IP44

R13694 vidro colorido opala/cromo

€ 198

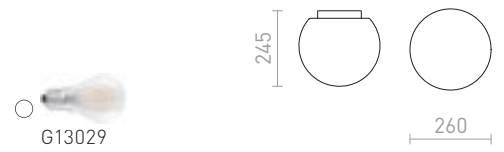

MERINGUE

Luminária de teto oval de vidro com base cromada. Adequada para casas de banho.

MERINGUE 11 TETO

230 V LED G9 9 W IP44

R13689 vidro colorido opala/cromo

€ 98 %

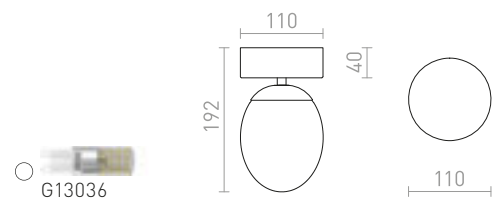

MERINGUE 16 TETO

230 V E27 15 W IP44

R13690 vidro colorido opala/cromo

€ 129 %

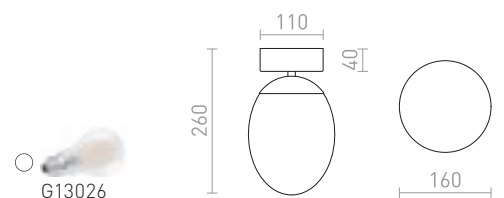



IP44

ESICA

Candeeiro de teto cilíndrico com LED e vidro opalino. Adequado para ambientes húmidos.

ESICA SQ TETO

230 V LED 6 W 3000 K 435 lm Ra 80 IP44

R12198 cromo

€ 78

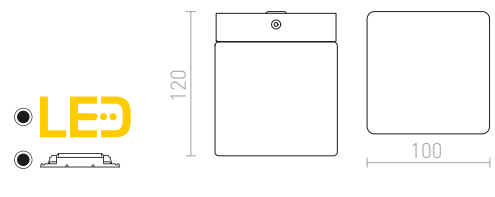

IP44

ESICA

Candeeiro de teto cilíndrico com LED e vidro opalino. Adequado para ambientes húmidos.

ESICA CYL TETO

230 V LED 6 W 3000 K 369 lm Ra 80 IP44

R12199 cromo

€ 88

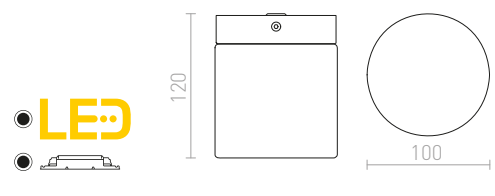

IP44

EIGHT

Luminária de teto com abajur de vidro opalino. Adequada para ambientes húmidos.

EIGHT TETO

230 V E27 28 W IP44

R10492 vidro colorido opala/cromo

€ 98 →

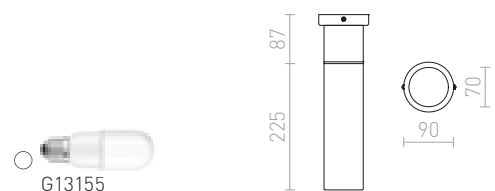





IP54



ORIN

Iluminação LED quadrada para teto com abajur acetinado.

ORIN SQ TETO

230 V LED 10 W 3000 K 800 lm Ra 80 IP54

R13628 branco/acrílico acetinado

€ 88

R13629 cinzento antracite/acrílico acetinado

€ 88

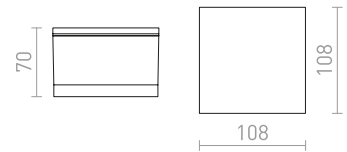
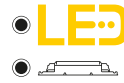

IP65

SENZA

Plafon LED para exterior. Luminária cilíndrica com tampa de vidro transparente preto em todo o perímetro.

SENZA R TETO

230 V LED 6 W 3000 K 480 lm Ra 80 IP65

R13622 branco/vidro transparente

€ 98

R13623 cinzento antracite/vidro transparente

€ 98

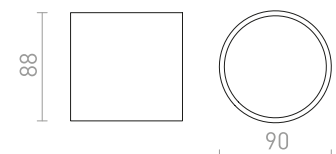
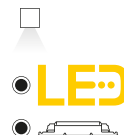



IP65

SENZA

Plafon de LED para exterior com cobertura de vidro transparente e circunda todo o perímetro.

SENZA SQ TETO

230 V LED 6 W 3000 K 580 lm Ra 80 IP65

R13624 branco/vidro transparente

€ 98

R13625 cinzento antracite/vidro transparente

€ 98

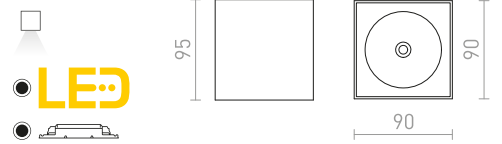

IP54

ORIN

Iluminação de teto cilíndrica LED para exterior com abajur acetinado.

ORIN R TETO

230 V LED 10 W 3000 K 650 lm Ra 80 IP54

R13626 branco/acrílico acetinado

€ 88

R13627 cinzento antracite/acrílico acetinado

€ 88

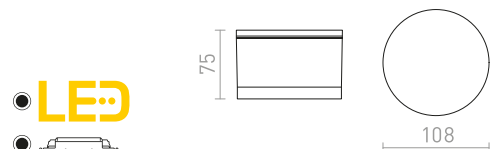



IP65

EILEEN

Cilindro de teto adequado para uso em casas de banho, para fonte de luz LED com casquilho GU10.

EILEEN TETO

230 V GU10 35 W IP65

R13606 branco

€ 58

R13607 preto

€ 58



117

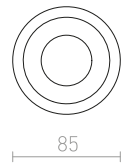



IP65

KIM

Prisma de teto adequado para uso em casas de banho, para fonte de luz LED com casquilho GU10.

KIM TETO

230 V GU10 35 W IP65

R13608 branco

€ 58

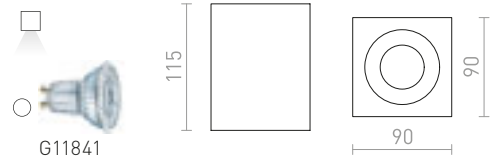

IP54

LOLA

Foco de teto com proteção para ambientes húmidos e adequado para casa de banho.

LOLA 88 TETO

230 V GU10 15 W IP54

R13538 branco

€ 48

R13539 cromo

€ 48

R13542 preto

€ 48

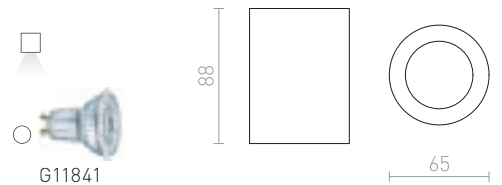

IP54

SAMMY

Foco de exterior com casquilho GU10. Com cobertura de vidro transparente na parte inferior.

SAMMY TETO

230 V LED GU10 15 W IP54

R13450 branco

€ 58

R13451 cinzento

€ 48

R13452 cinzento antracite

€ 58

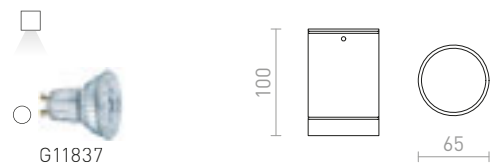



MERIDO

Luminária de teto exterior para fontes de luz GX53 de baixo consumo energético.

MERIDO TETO

230 V GX53 11 W IP54

R10428 branco

€ 68

R10429 cinzento prata

€ 68

R10430 cinzento antracite

€ 68

IP54

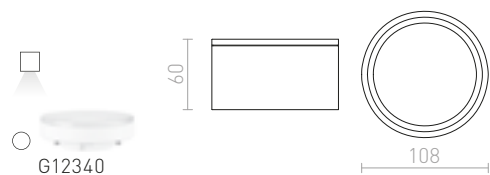



IP54

LIZZI

Foco externo com casquilho GU10.

LIZZI TETO

230 V GU10 35 W IP54

R13505 branco

€ 58

R13506 cinzento prata

€ 58

R13507 cinzento antracite

€ 58

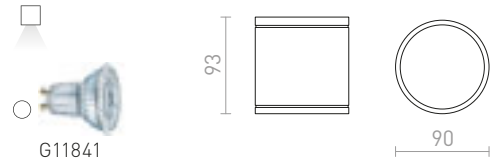

IP54

RODGE

Foco de exterior com casquilho GU10.

RODGE TETO

230 V GU10 35 W IP54

R13503 branco

€ 58

R13510 cinzento

€ 58

R13511 cinzento antracite

€ 58

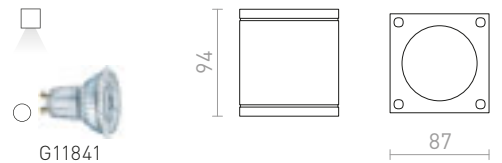

IP54

DEZA

Luminária de teto de alumínio maciço com cobertura de vidro acetinado.

DEZA QUADRADO

230 V G9 25 W IP54

R10166 alumínio/vidro acetinado

€ 48

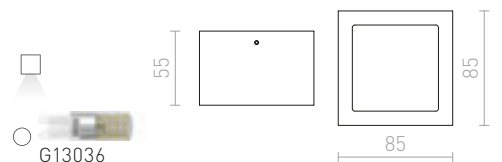



IP54

SPECTACLE

Luz externa de alumínio fundido com LED integrado e um difusor de cor opala. Para montagem em teto ou parede.

SPECTACLE SUPERFÍCIE

230 V LED 5 W 3000 K 350 lm Ra80 IP54

R11968 cinzento prata

€ 120 %

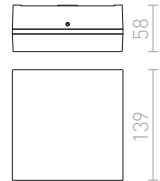
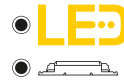

IP65

BONO

Luz externa de alumínio fundido com LED integrado e um difusor de cor opala. Para montagem no teto ou na parede.

BONO SUPERFÍCIE

230 V LED 4 W 3000 K 297 lm Ra80 IP65

R11967 cinzento antracite

€ 178

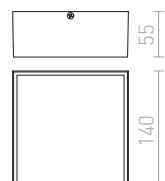
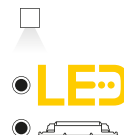



IP44

KATHARIS

Plafon para ambientes húmidos, para instalação somente em paredes e tetos ocultos.

KATHARIS SQ 28 PARA TETOS OCOS

230 V LED 24 W 3000 K 1820 lm Ra 80 IP44

R12524 branco

€ 98

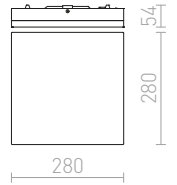

IP44

MERANO

Plafon de LED quadrado adequado para ambientes húmidos.

MERANO LED 30 TETO

230 V LED 16 W 3000 K 1300 lm Ra 80 IP44

R13697 cromo/acrílico fosco

€ 188

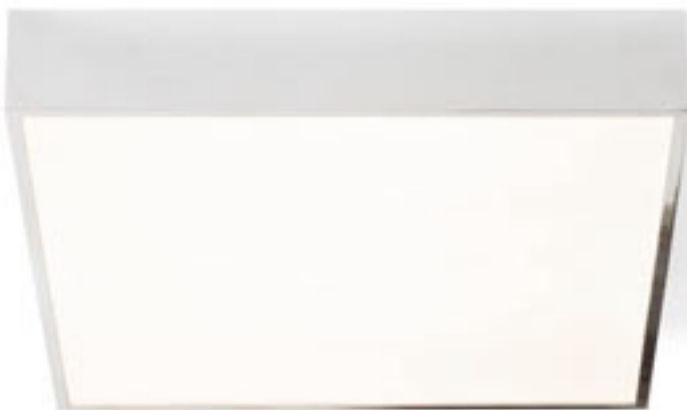
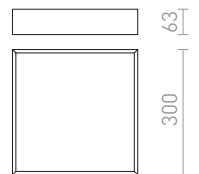

IP44

MERANO LED 35 TETO

230 V LED 24 W 3000 K 1700 lm Ra 80 IP44

R13698 cromo/acrílico fosco

€ 229

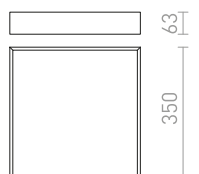



COLIN

Luminária de teto de gesso para casquilho GU10. Pode ser pintada com tintas para interiores.

COLIN TETO

230 V LED GU10 5 W

R13791 gesso

€ 58 **NEW**

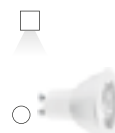

G13466

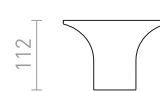

112

68



166



GINA

Luminária de teto de gesso para fonte de luz LED com casquilho GU10. A luminária pode ser pintada com tinta para interiores.

GINA III TETO

230 V LED GU10 3x5 W

R13789 gesso

€ 120 **NEW**

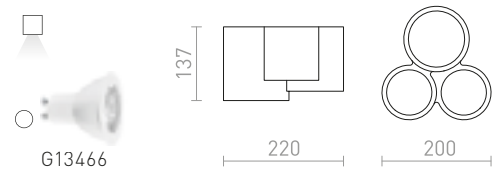

GINA

Luminária de teto de gesso para casquilho GU10. Pode ser pintada com tintas para interiores.

GINA TETO

230 V LED GU10 15 W

R11680 gesso

€ 78

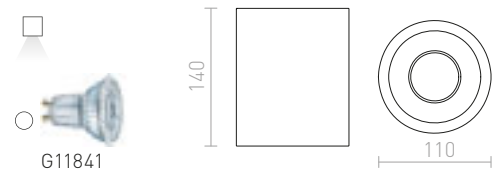

GINA S 17 TETO

230 V GU10 15 W

R12354 gesso

€ 58

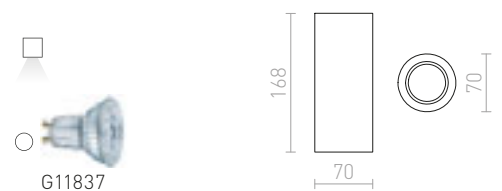





JACK

Luminária de teto de gesso para fonte de luz LED com casquilho GU10. A luminária pode ser pintada com tinta para interiores.

JACK III TETO

230 V LED GU10 3x5 W

R13790 gesso

€ 150 NEW

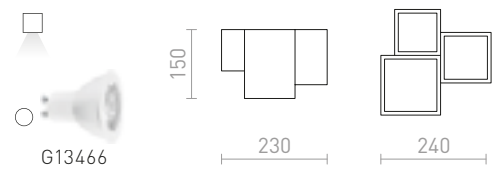

JACK

Luminária angular de gesso para fonte de luz com casquilho GU10. A luminária pode ser pintada com tintas para interiores.

JACK SQ TETO

230 V LED GU10 15 W

R11957 gesso

€ 78

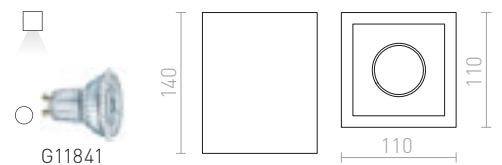

JACK SQ S 17 TETO

230 V GU10 15 W

R12751 gesso

€ 38 %

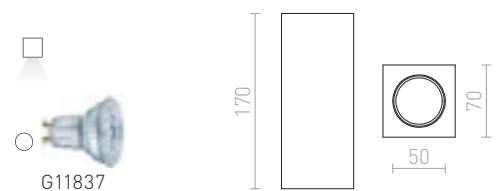



VOLCA

Luminária de teto de cimento para fontes de luz LED com casquilho GU10.

VOLCA TETO

230 V LED GU10 5 W

R13795 cimento/granito escuro

€ 48 **NEW**

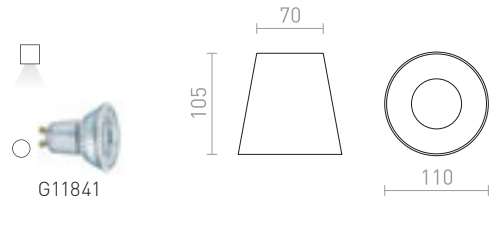

COLES

Luminária de teto para uma fonte de luz que pode ser inclinada em um eixo. A luminária pode ser pintada com tintas para interiores.

COLES SQ LUZ DE TETO

230 V LED GU10 15 W

R13438 gesso

€ 88 **%**

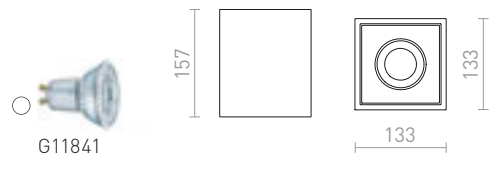

COLES

Luminária de teto para uma fonte de luz que pode ser inclinada em um eixo. A luminária pode ser pintada com tintas para interiores.

COLES DIRECIONAL DE TETO

230 V GU10 15 W

R10454 gesso

€ 120

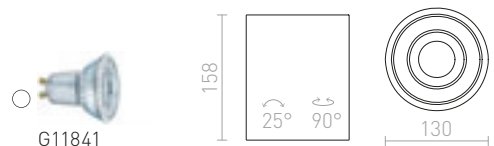



ATIKA

Plafon em gesso com vidro acetinado para três fontes de luz E27. A superfície pode ser pintada com tintas para interiores.

ATIKA TETO

230 V E27 3x28 W

R12492 gesso

€ 138 %

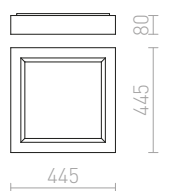



BOGARD

Luminária de teto LED com um foco fixo e um ajustável.

BOGARD TWIN TETO

230 V LED 2x5 W $\angle 40^\circ$ 3000 K 700 lm Ra 80

R12499 mate preto

€ 138

R12500 níquel mate

€ 88

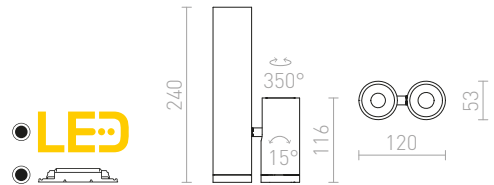

BOGARD

Foco direcional tubular LED de teto ajustável.

BOGARD TETO

230 V LED 5 W $\angle 40^\circ$ 3000 K 414 lm Ra 80

R12497 mate preto

€ 78

R12498 níquel mate

€ 78



BELENOS

Foco cilíndrico minimalista para fontes de luz GU10 sobre base redonda. As molas ligadas ao casquilho permitem o uso de fontes de luz de vários comprimentos.

BELENOS TETO

230 V LED GU10 9 W

R13363 branco

€ 48

R13364 preto

€ 48

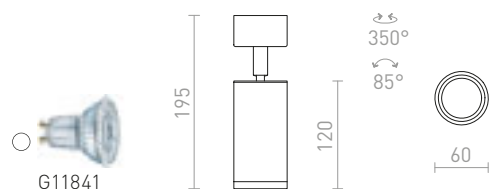





DARIO

Luminária cilíndrica direcional com casquilho GU10 para fontes de luz LED, incluindo um tom decorativo de latão preto escovado. Diferentes combinações de cores estão disponíveis comprando tons adicionais em outras cores.

DARIO TETO

230 V GU10 9 W

R13867 branco/latão escovado

€ 68

NEW

R13868 preto/latão escovado

€ 68

NEW

R13869 latão escovado

€ 78

NEW

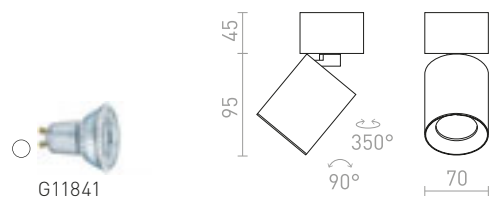
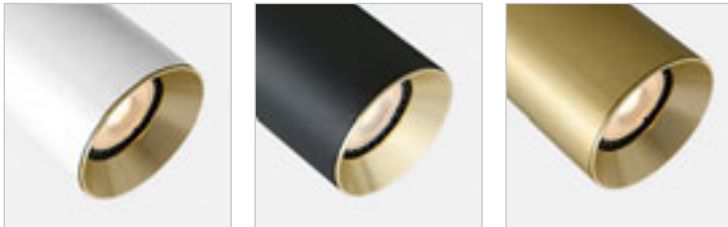

DARIO

Tonalidade decorativa interna de metal em várias cores para a luz DARIO.

DARIO ANEL DECORATIVO

R13876 branco

€ 9.80

NEW

R13877 preto

€ 9.80

NEW

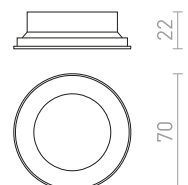
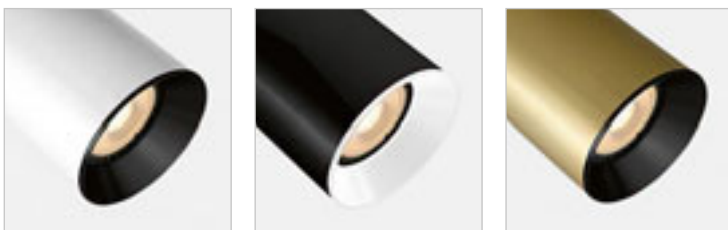



PIXIE

Luminária inclinada na base para fontes de luz LED GX53 de baixo consumo energético.

PIXIE DIRECIONAL

230 V LED GX53 7 W

R11772 branco/cromo

€ 138

R11773 preto/cromo

€ 138

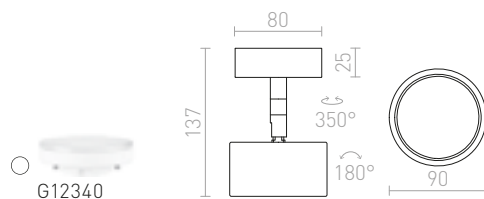

SNAZZY

Luminária de teto cilíndrica inclinável para fontes de luz GU10.

SNAZZY

230 V GU10 35 W

R12670 branco

€ 78

R13552 preto

€ 78

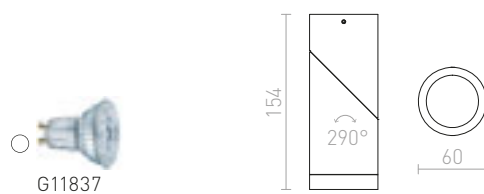

CONDU

Luminária de teto cilíndrica sólida e inclinável com LED integrado.

CONDU TETO

230 V LED 20 W $\angle 24^\circ$ 3000 K 1600 lm Ra 80

R12839 branco

€ 120

R12840 preto

€ 120

R12841 cromo

€ 98

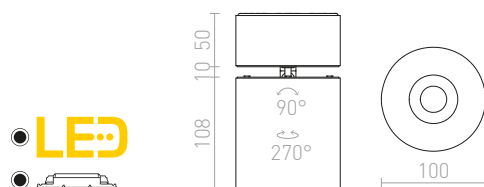



KELLY LED

Luminária de teto regulável com fonte de luz LED fixa integrada. Regulação da intensidade da luz TRIAC.

KELLY LED DIMM TETO

230 V LED 15 W $\angle 45^\circ$ 3000 K 750 lm Ra 80

R12633 branco

€ 129

R12634 preto

€ 129

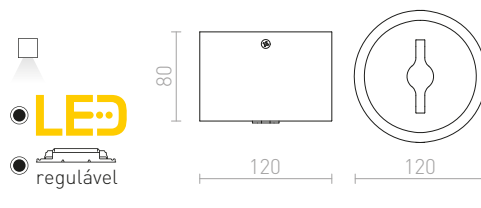

RIGA

Luz de teto com LED integrado, disponível em quatro cores.

RIGA 18 TETO

230 V LED 4 W $\angle 38^\circ$ 3000 K 285 lm Ra 80

R12448 cromo

€ 68

R12449 cobre

€ 68

R12450 branco

€ 88

R12451 preto

€ 78



RIGA 38 TETO

230 V LED 6 W $\angle 38^\circ$ 3000 K 570 lm Ra 80

R12452 cromo

€ 78

R12453 cobre

€ 78

R12454 branco

€ 88

R12455 preto

€ 88

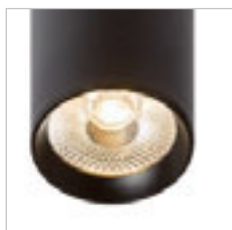



CONNOR

Foco de teto cilíndrico com casquilho GU10 fixo.

CONNOR TETO

230 V LED GU10 10 W

R13496 branco/preto

€ 38

R13501 preto/ouro

€ 38



G11841

96

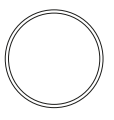

69



CANTO

Foco de teto cilíndrico adequado para combinar com anel decorativo Canto.

CANTO FOCO SEM ABAJUR INTERNO

230 V LED GU10 8 W

R13471 branco

€ 48

R13472 preto

€ 48



G11841

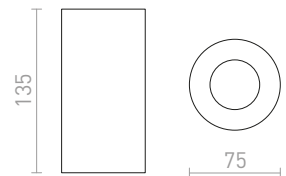

CANTO

Anel decorativo, disponível em quatro cores para candeeiro Canto.

CANTO ANEL DECORATIVO

R13473 branco

€ 5.80

R13474 ouro

€ 5.80

R13475 folha de cobre

€ 5.80

R13476 preto

€ 5.80

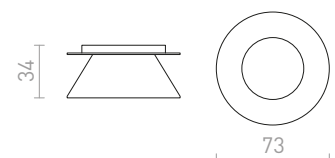



TUBA

Foco de teto cilíndrico para fontes de luz fixas GU10.

TUBA TETO

230 V GU10 35 W

R12745 mate branco/ouro

€ 58

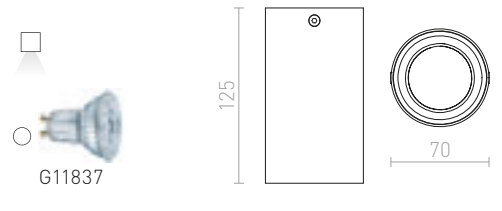

VADE

Foco de teto para fontes de luz fixas GU10.

VADE R

230 V GU10 35 W

R12669 branco/preto

€ 48

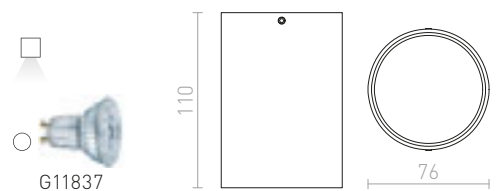



MAYO

Foco cilíndrico direcional montado em superfície com LED integrado. Driver incluído.

MAYO R TETO DIRECIONAL

230 V LED 9 W $\angle 36^\circ$ 2700 K 400 lm Ra 80

R10374 alumínio escovado

€ 88

%

R10375 branco

€ 120

%

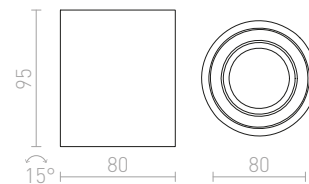



PIXIE

Luminária de teto de alumínio para fontes de luz LED GX53 de baixo consumo energético.

PIXIE TETO

230 V LED GX53 7 W

R11770 branco/cromo

€ 129

R11771 preto/cromo

€ 129

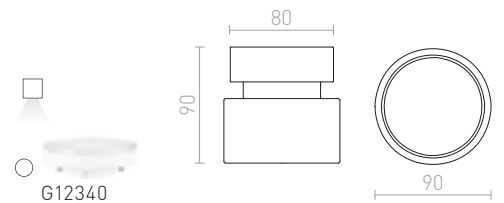

MEA

Luz de teto cilíndrica para fonte de luz E27 de baixo consumo energético, com cobertura de vidro acetinado.

MEA TETO CILÍNDRICO

230 V E27 18 W

R10195 branco

€ 58

R10212 alumínio escovado

€ 58

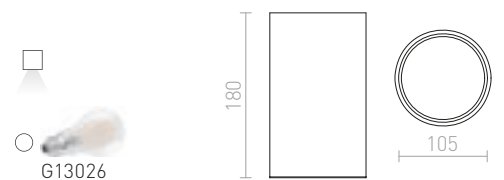



MOCCA

Luminária cilíndrica de alumínio polido com fonte de luz inclinável.

MOCCA TETO
230 V GU10 50 W

R10124 alumínio

€ 88 →

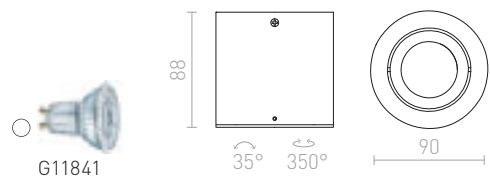



MOMA

Luminária de teto cilíndrica inclinável para fonte de luz com casquilho GU10.

MOMA DIRECIONAL

230 V GU10 35 W

R12044 branco

€ 58

R12517 preto

€ 58

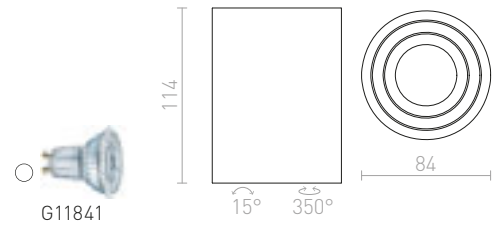

MOMA

Luminária de teto cilíndrica para uma fonte de luz halógena fixa com uma altura máxima de 56 mm.

MOMA TETO

230 V GU10 35 W

R12043 branco

€ 35

R12047 níquel mate

€ 26

R12516 preto

€ 35

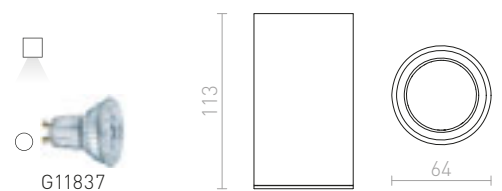



MANTOVA

Luminária de teto com casquilho fixo GU10.

MANTOVA I TETO

230 V GU10 35 W

R12729 mate branco

€ 38

R12730 alumínio escovado

€ 38

R12731 mate preto

€ 38

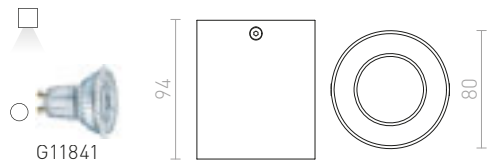

MANTOVA II TETO

230 V GU10 2x35 W

R12732 mate branco

€ 78

R12733 alumínio escovado

€ 48

R12734 mate preto

€ 78



GAYA

Foco de teto cilíndrico montado em superfície para fonte de luz com casquilho GU10.

GAYA

230 V GU10 35 W

R12667 branco

€ 32

R12668 preto

€ 32

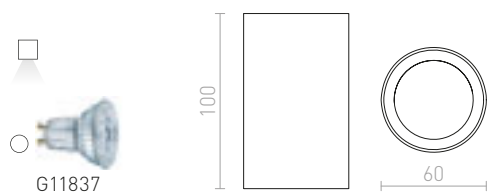



MILANO

Luminária de teto montada em superfície com inclinação para fontes de luz GU10.

MILANO I TETO

230 V GU10 35 W

R12681 mate preto/alumínio escovado

€ 48

R12682 alumínio escovado

€ 58

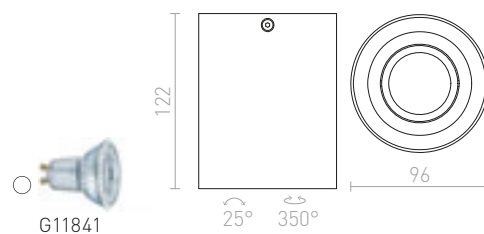

MILANO II TETO

230 V GU10 2x35 W

R12683 mate preto/alumínio escovado

€ 88

R12684 alumínio escovado

€ 88

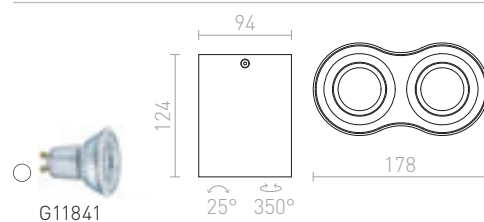



CUBO

Luminária de teto angular em alumínio para fonte de luz G10.

CUBO EM SUPERFÍCIE

230 V GU10 50 W

R10168 alumínio

€ 48 %



G11841

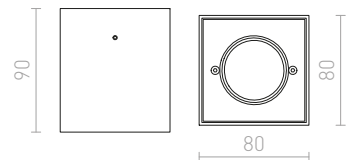



AGATE

Luminária de teto angular para fontes de luz com casquilho GU10 fixo.

AGATE I TETO

230 V GU10 35 W

R12735 mate branco

€ 38

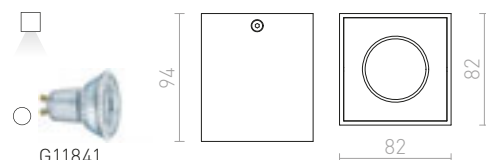

AGATE II TETO

230 V GU10 2x35 W

R12737 mate branco

€ 68

R12738 alumínio escovado

€ 48

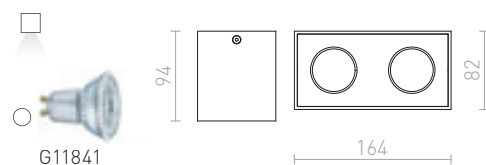

ENKI

Luminária de teto angular montada em superfície com inclinação e casquilho GU10.

ENKI EDG I

230 V GU10 35 W

R12672 branco

€ 68

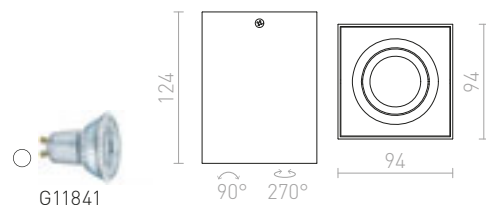

ENKI EDG II

230 V GU10 2x35 W

R12673 branco

€ 98

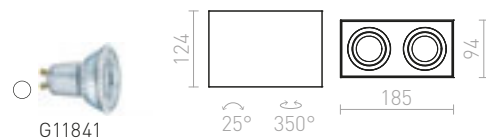



MEA

Luz de teto para fontes de luz de baixo consumo energético, com vidro acetinado. Disponível em duas cores.

MEA TETO ANGULAR

230 V E27 18 W

R10196 branco

€ 48 %

R10213 alumínio escovado

€ 48 %



235

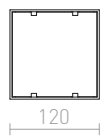
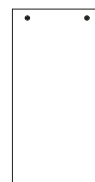



BERIT

Luminária de teto retangular em alumínio para fontes de luz GU10 inclináveis em dois eixos.

BERIT I

230 V GU10 50 W

R10119 alumínio

€ 58 %

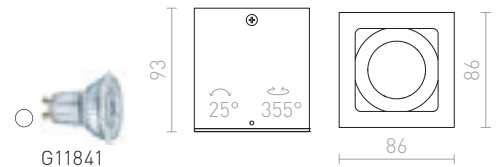

BERIT II

230 V GU10 2x50 W

R10120 alumínio

€ 78 %

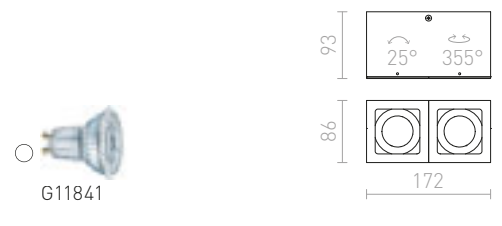

MAYO

Foco angular montado em superfície com LED integrado. Driver incluído.

MAYO SQ TETO DIRECIONAL

230 V/700 mA LED 9 W $\angle 36^\circ$ 2700 K 400 lm Ra 80

R10325 alumínio escovado

€ 120 %

R10326 branco

€ 120 %

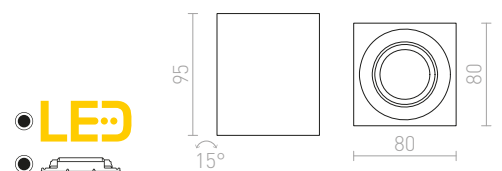



EX

Luminária de teto com indentação, para fonte de luz halogénea sem inclinação.

EX 111 TETO QUADRADO

230 V/12 V G53 50 W

R13491 alumínio escovado

€ 88 %

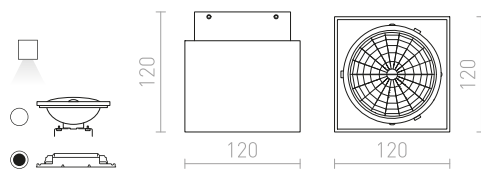

JAMES

Luminária de teto lacado com LED embutido que pode ser inclinado em dois eixos. Regulação da intensidade da luz TRIAC.

JAMES I DIMM TETO

230 V LED 15 W $\angle 24^\circ$ 3000 K 800 lm Ra 80

R13361 mate branco

€ 120 %

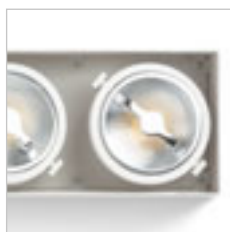
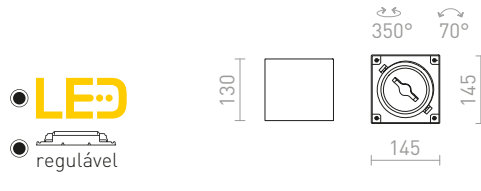

JAMES II DIMM TETO

230 V LED 2x15 W $\angle 24^\circ$ 3000 K 1600 lm Ra 80

R13362 mate branco

€ 188 %

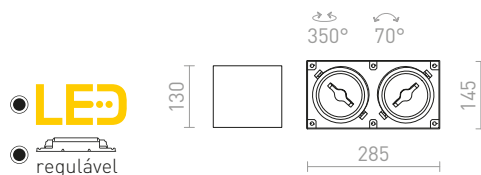





EX

Luminária de teto com indentação, para fonte de luz halogénea sem inclinação.

EX GU10 TETO QUADRADO

230 V GU10 50 W

R10164 cinzento prata

€ 14.50

%

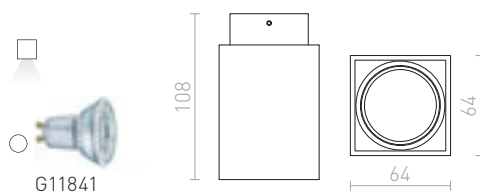

MARVEL

Luminária angular de alumínio para duas fontes de luz GU10.

MARVEL DIRECIONAL

230 V GU10 2x50 W

R10167 alumínio

€ 48

%

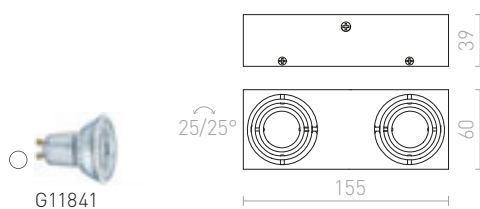



MARVEL

Luminária angular de alumínio para duas fontes de luz GU10 que podem ser inclinadas individualmente em base central.

MARVEL II DIRECIONAL

230 V GU10 2x50 W

R10171 alumínio

€ 48 %

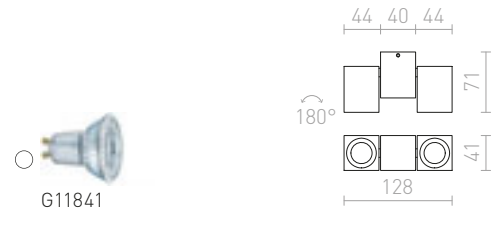

MARVEL

Luminária angular de alumínio para fontes de luz GU10, sem inclinação.

MARVEL TETO

230 V GU10 50 W

R10122 alumínio

€ 16.50 %

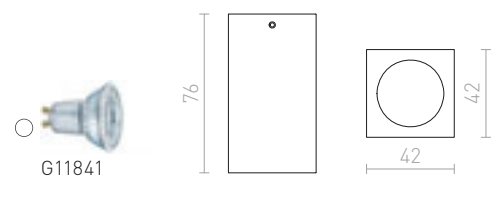

MARVEL II

230 V GU10 2x50 W

R10123 alumínio

€ 17.50 %

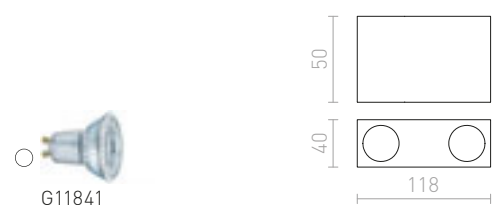





TACO

Foco cilíndrico de teto com um abajur têxtil e casquilho E27, adequado para fontes de luz com eficiência energética.

TACO TETO

230 V E27 15 W

R12471 preto/cromo

€ 58

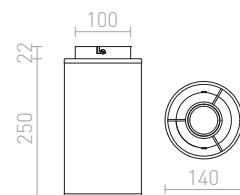

OTIS

Luminária têxtil dupla redonda de teto para fontes de luz E27. A tonalidade interna é sempre branca.

OTIS 50 TETO

230 V E27 3x28 W

R12490 branco/branco

€ 335

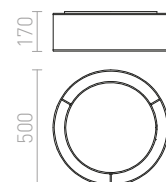

OTIS 60 TETO

230 V E27 4x28 W

R13807 branco/branco

€ 420

R13808 preto transparente/branco

€ 420

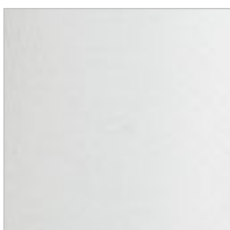
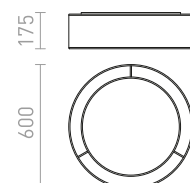



MARA

Luminária de teto de LED com base cromada e difusor ligeiramente convexo.

MARA TETO

230 V LED 24 W 3000 K 1760 lm Ra 80

R12894 acrílico fosco/cromo

€ 138

%

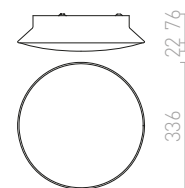

IP44

VENICE

Luminária de teto, combinação de opala no interior e vidro transparente no exterior sobre base cromada, para casquilho LED E27. Adequado para ambientes húmidos

VENICE 23 TETO

230 V E27 20 W IP44

R13684 vidro transparente/vidro colorido opala/cromo

€ 215



G13307

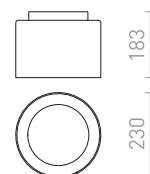

IP44

VENICE

Plafon LED, combinação de opala no interior e vidro transparente no exterior sobre base cromada. Adequado para ambientes húmidos.

VENICE LED 30 TETO

230 V LED 12 W 3000 K 900 lm Ra 80 IP44

R13685 vidro transparente/vidro colorido opala/cromo

€ 258

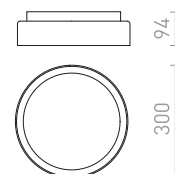







MELISA

Luminária montada em superfície com LED integrado abajur de acrílico fosco e moldura de alumínio escovado.

MELISA 25 TETO

230 V LED 12 W 3000 K 840 lm Ra 80

R11296 alumínio

€ 58 %

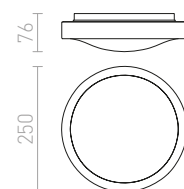

MELISA 52 TETO

230 V LED 40 W 3000 K 2200 lm Ra 80

R11297 alumínio

€ 138 %

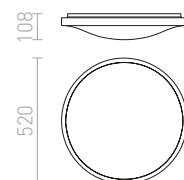

ARANA

Luminária de teto retangular com base em níquel mate. O abajur é de vidro fosco.

ARANA SQ DE SUPERFÍCIE

230 V E14 2x30 W

R10498 níquel mate

€ 58 %

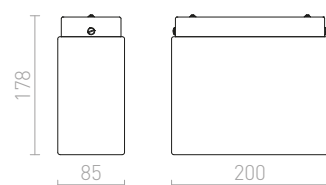



MEZZO

Plafon de teto com fonte de luz LED embutida e moldura de alumínio lacada. O equipamento é fornecido com um difusor de luz em policarbonato fosco. Com o kit de suspensão (R13330 ou R13331), o plafon pode ser instalado como suspenso. Regulação da intensidade da luz TRIAC.

MEZZO 40 DIMM TETO

230 V LED 30 W 3000 K 1800 lm Ra 80

R13328 branco

€ 268

R13329 preto

€ 290

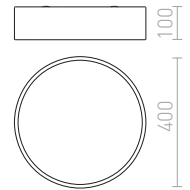
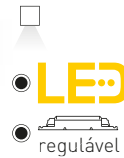

MEZZO 60 DIMM TETO

230 V LED 60 W 3000 K 3700 lm Ra 80

R13332 branco

€ 560

R13333 preto

€ 560

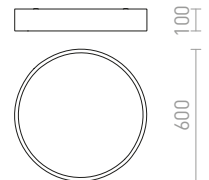
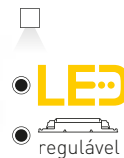

MEZZO 80 DIMM TETO

230 V LED 100 W 3000 K 6400 lm Ra 80

R13334 branco

€ 950

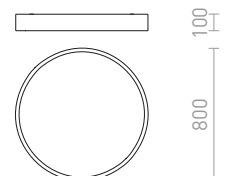
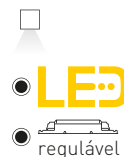





LARISA

Plafon com LED e moldura minimalista.

LARISA R 12 TETO

230 V LED 10 W 3000 K 800 lm Ra 80

R12842 branco	€ 58
R12843 ouro pérola	€ 58
R13479 preto	€ 58

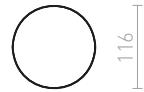
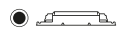

LARISA R 22 TETO

230 V LED 20 W 3000 K 1600 lm Ra 80

R13481 branco	€ 98
R13482 ouro pérola	€ 98
R13483 preto	€ 98

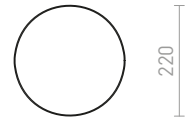
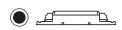

LARISA R 30 TETO

230 V LED 30 W 3000 K 2400 lm Ra 80

R12844 branco	€ 138
R12845 ouro pérola	€ 150
R13480 preto	€ 138

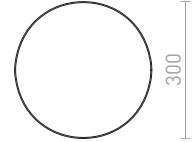
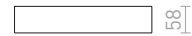
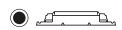

LARISA R 40 TETO

230 V LED 50 W 3000 K 4000 lm Ra 80

R13484 branco	€ 215
R13485 ouro pérola	€ 229
R13486 preto	€ 215

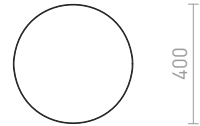
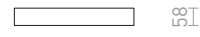
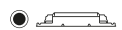





LARISA

Plafon com LED e moldura minimalista. Regulação da intensidade da luz TRIAC.

LARISA R 12 DIMM TETO

230 V LED 10 W 3000 K 800 lm Ra 80

R13157 branco

€ 88 NEW

R13164 ouro pérola

€ 88 NEW

R13551 preto

€ 88 NEW



LED

regulável

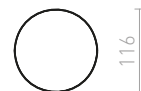
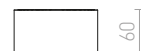

LARISA R 22 DIMM TETO

230 V LED 20 W 3000 K 1600 lm Ra 80

R13844 branco

€ 129 NEW

R13743 ouro pérola

€ 129 NEW

R13843 preto

€ 129 NEW



LED

regulável

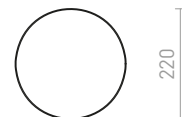
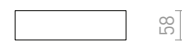

LARISA R 30 DIMM TETO

230 V LED 30 W 3000 K 2400 lm Ra 80

R13177 branco

€ 158 NEW

R13178 ouro pérola

€ 178 NEW

R13570 preto

€ 158 NEW



LED

regulável

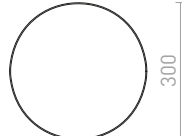
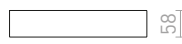







HUE

Luminária muito fina montada em superfície com LED de alta potência integrado. A moldura está disponível em cromo, cromo preto, níquel mate, laca branca e imitação de madeira.

HUE R 9 TETO

230 V LED 6 W 3000 K 540 lm Ra 80

R12790 branco	€ 24	%
R12791 cromo preto	€ 19	%
R12792 cromo	€ 26	%
R12793 níquel mate	€ 28	▶
R12794 faixa decorativa	€ 28	▶

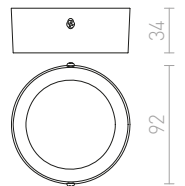
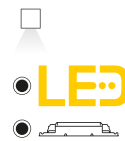

HUE R 17 TETO

230 V LED 18 W 3000 K 1620 lm Ra 80

R12795 branco	€ 58	%
R12798 níquel mate	€ 48	%
R12799 faixa decorativa	€ 58	%
R13404 imitação de imbuia escura	€ 58	▶

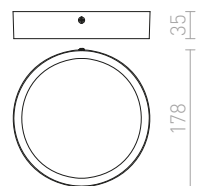
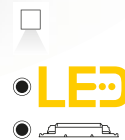

HUE R 22 TETO

230 V LED 24 W 3000 K 2160 lm Ra 80

R12800 branco	€ 68	▶
R12801 cromo preto	€ 68	▶
R12802 cromo	€ 78	▶
R12804 faixa decorativa	€ 78	▶
R13405 imitação de imbuia escura	€ 78	%

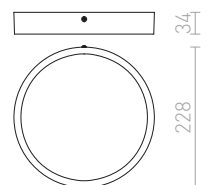
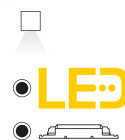



HUE

Luminária muito fina montada em superfície com LED de alta potência integrado e regulável. A moldura está disponível em cromo, cromo preto, níquel mate, laca branca e imitação de madeira. Regulação da intensidade da luz TRIAC.

HUE R 9 DIMM TETO

230 V LED 6 W 3000 K 540 lm Ra 80

R13137 branco	€ 58
R13138 cromo preto	€ 58 →
R13139 cromo	€ 58 →
R13140 níquel mate	€ 58 →
R13141 faixa decorativa	€ 58 →

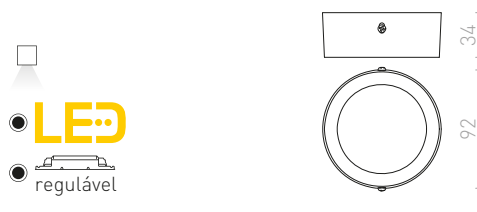

HUE R 17 DIMM DE TETO

230 V LED 18 W 3000 K 1620 lm Ra 80

R13073 branco	€ 120
R13076 níquel mate	€ 120 →
R13077 faixa decorativa	€ 120 →
R13444 imitação de imbuia escura	€ 120 →

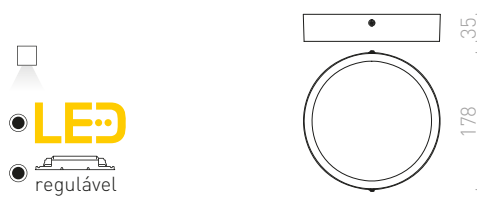

HUE R 22 DIMM DE TETO

230 V LED 24 W 3000 K 2160 lm Ra 80

R13078 branco	€ 129 →
R13079 cromo preto	€ 129 →
R13080 cromo	€ 138 →
R13082 faixa decorativa	€ 138 →
R13445 imitação de imbuia escura	€ 150 →









MENSA

Plafon LED de teto quadrado com moldura em alumínio. Inclui um difusor de acrílico fosco.

MENSA R 40 TETO

230 V LED 28 W 3000 K 1820 lm Ra 80

R12115 alumínio escovado

€ 238

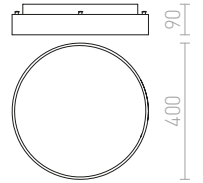
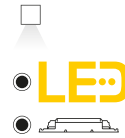

MENSA R 80 TETO

230 V LED 80 W 3000 K 6800 lm Ra 80

R12119 alumínio escovado

€ 680

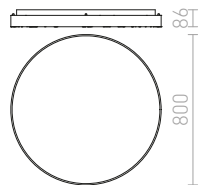
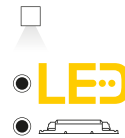

ALLEGRO

Plafon LED com moldura de alumínio pintado. Inclui difusor embutido em acrílico fosco. Regulação da intensidade da luz TRIAC.

ALLEGRO II 43 DIMM TETO

230 V LED 30 W 3000 K 1950 lm Ra 80

R13730 branco

€ 398

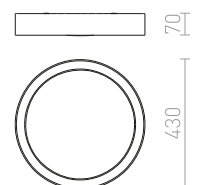
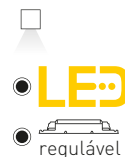



SLENDER

Luminária LED fina montada em superfície.

SLENDER R 12 SUPERFÍCIE

230 V LED 6 W 3000 K 540 lm Ra 80

R11281 níquel mate

€ 17 %

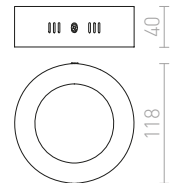
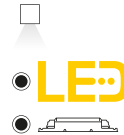

SLENDER SQ 12 SUPERFÍCIE

230 V LED 6 W 3000 K 540 lm Ra 80

R11284 níquel mate

€ 22 %

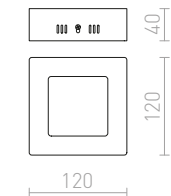
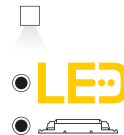

SLENDER SQ 22 MONTADO EM SUPERFÍCIE

230 V LED 18 W 3000 K 1620 lm Ra 80

R11285 níquel mate

€ 35 %

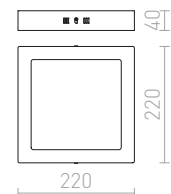
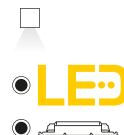

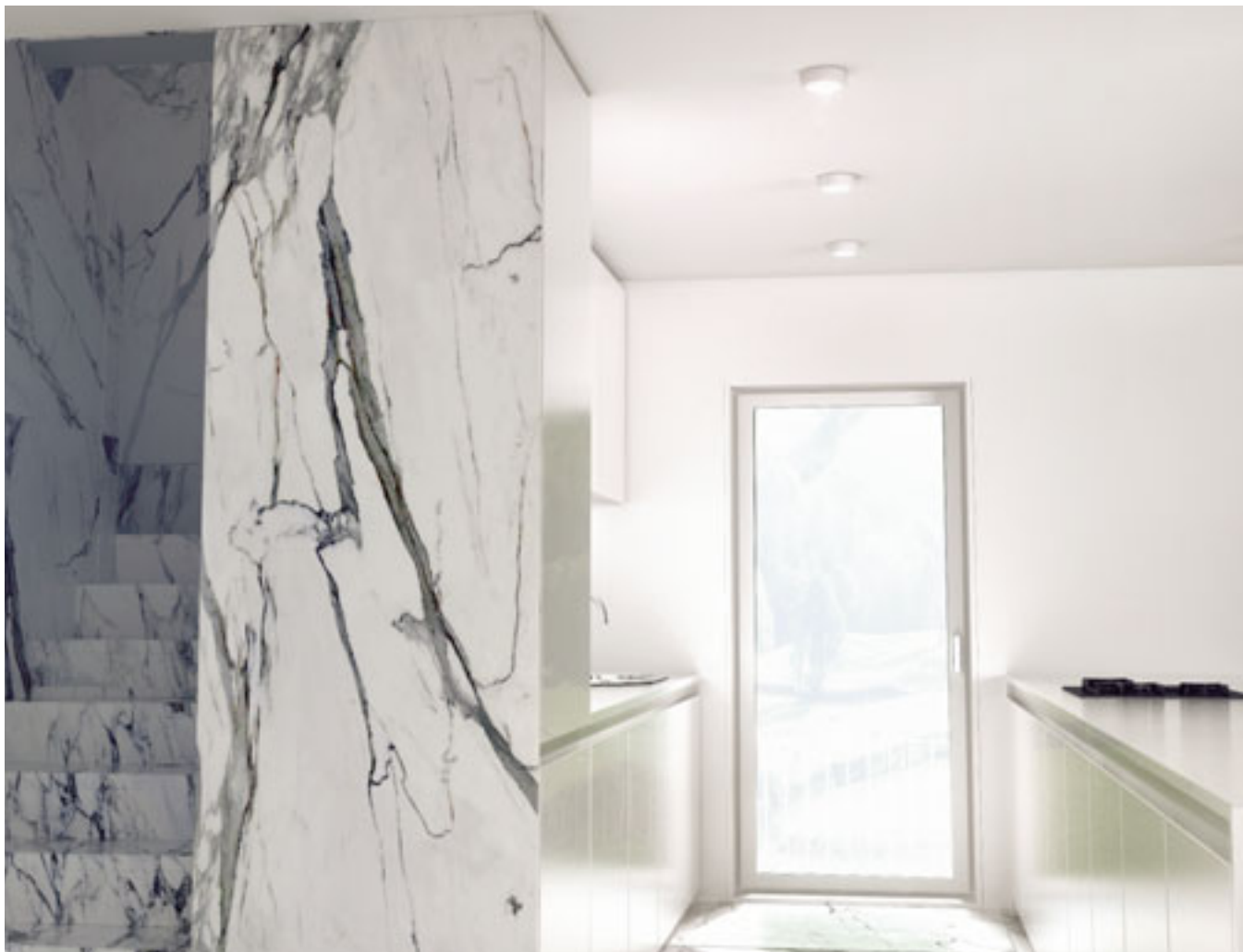

SOCORRO

Luminária plana montada em superfície com LED integrado.

SOCORRO R 120 DE SUPERFÍCIE

230 V LED 6 W 3000 K 480 lm Ra 80

R12971 branco

€ 18 %

● LED

● regulamento
opcional

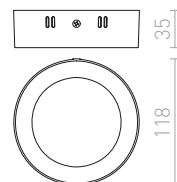

SOCORRO R 300 DE SUPERFÍCIE

230 V LED 24 W 3000 K 1920 lm Ra 80

R12973 branco

€ 58 ↗

● LED

● regulamento
opcional

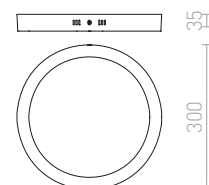





LARISA

Plafon com LED e moldura minimalista.

LARISA SQ 17 TETO

230 V LED 15 W 3000 K 1200 lm Ra 80

R12848 branco

€ 78

R12849 preto

€ 78

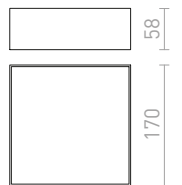
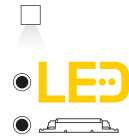

LARISA SQ 22 TETO

230 V LED 20 W 3000 K 1600 lm Ra 80

R13487 branco

€ 98

R13488 preto

€ 98

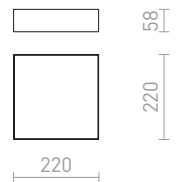
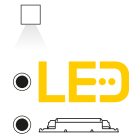

LARISA SQ 30 TETO

230 V LED 30 W 3000 K 2400 lm Ra 80

R12850 branco

€ 150

R12851 preto

€ 150

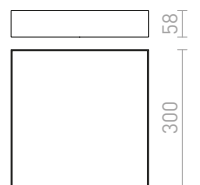
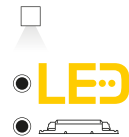

LARISA SQ 40 TETO

230 V LED 50 W 3000 K 4000 lm Ra 80

R13489 branco

€ 198

R13490 preto

€ 198

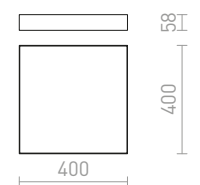
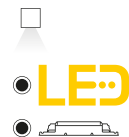





LARISA

Plafon com LED e moldura minimalista. Regulação da intensidade da luz TRIAC.

LARISA SQ 17 DIMM TETO

230 V LED 15 W 3000 K 1200 lm Ra 80

R13158 branco

€ 98 NEW

R13938 preto

€ 98 NEW

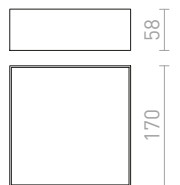

LARISA SQ 22 DIMM DE TETO

230 V LED 20 W 3000 K 1600 lm Ra 80

R13851 branco

€ 120 NEW

R13939 preto

€ 120 NEW

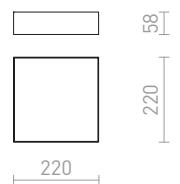
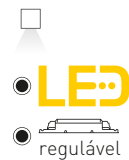

LARISA SQ 30 DIMM TETO

230 V LED 30 W 3000 K 2400 lm Ra 80

R13267 branco

€ 178 NEW

R13268 preto

€ 178 NEW

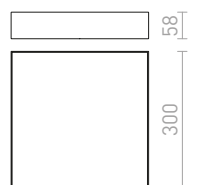
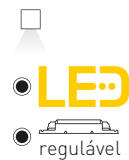

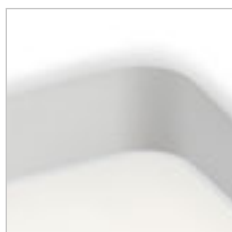
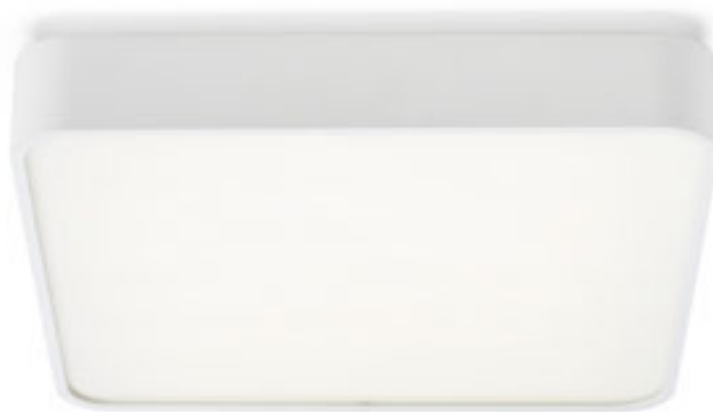

MENSA

Plafon LED quadrado de teto com moldura em alumínio lacado ou escovado. Inclui um difusor de acrílico fosco. Inclui um difusor de acrílico fosco.

MENSA SQ 40 TETO

230 V LED 38 W 3000 K 2470 lm Ra 80

R10582 branco

€ 229 %

R11290 alumínio escovado

€ 229 %

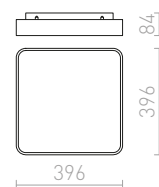
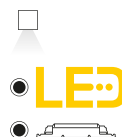

MENSA SQ 48 TETO

230 V LED 56 W 3000 K 3640 lm Ra 80

R11299 alumínio escovado

€ 258 %

R12120 branco

€ 278 →

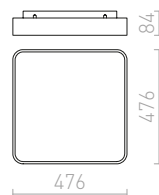
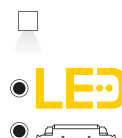

MENSA SQ 80 TETO

230 V LED 138 W 3000 K 8700 lm Ra 80

R12121 alumínio escovado

€ 580 %

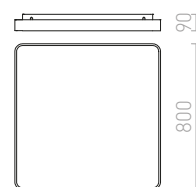
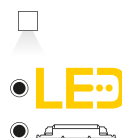





STRUCTURAL

Plafon LED montado em superfície com moldura em alumínio lacado. Inclui o driver.

STRUCTURAL LED 40x40 DE SUPERFÍCIE

230 V LED 40 W 3000 K 2918 lm Ra 80

R12063 branco

€ 268

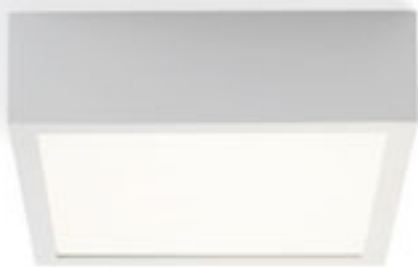
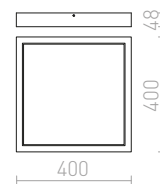

STRUCTURAL

Plafon LED em perfil de alumínio, design elegante em alumínio natural ou lacado a branco com difusor PMMA opalino com iluminação embutida.

STRUCTURAL LED 20x20 DE SUPERFÍCIE

230 V LED 12 W 3000 K Ra 80

R13707 branco

€ 150

R13708 alumínio escovado

€ 158

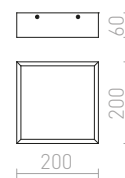
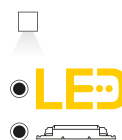

STRUCTURAL LED 55x55 DE SUPERFÍCIE

230 V LED 48 W 3000 K Ra 80

R13711 branco

€ 220

R13712 alumínio escovado

€ 238

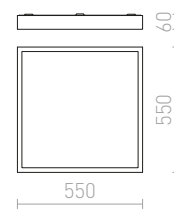
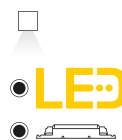







HUE

Luminária muito fina montada em superfície com LED de alta potência integrado. A moldura está disponível em cromo, cromo preto, níquel mate, laca branca e imitação de madeira.

HUE SQ 9 TETO

230 V LED 6 W 3000 K 540 lm Ra 80

R12805 branco	€ 24	%
R12806 cromo preto	€ 22	%
R12807 cromo	€ 19.50	%
R12808 níquel mate	€ 16.50	%
R12809 faixa decorativa	€ 28	→

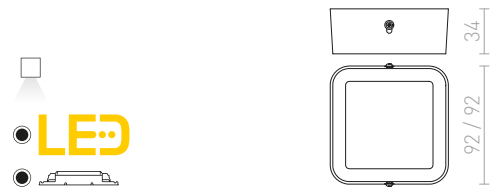

HUE SQ 17 TETO

230 V LED 18 W 3000 K 1620 lm Ra 80

R12810 branco	€ 58	%
R12811 cromo preto	€ 35	%
R12812 cromo	€ 35	%
R12813 níquel mate	€ 48	%
R12814 faixa decorativa	€ 68	→

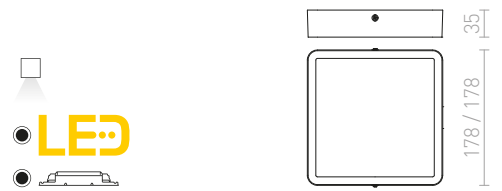

HUE SQ 22 TETO

230 V LED 24 W 3000 K 2160 lm Ra 80

R12815 branco	€ 78	%
R12816 cromo preto	€ 48	%
R12817 cromo	€ 68	%
R12818 níquel mate	€ 48	%

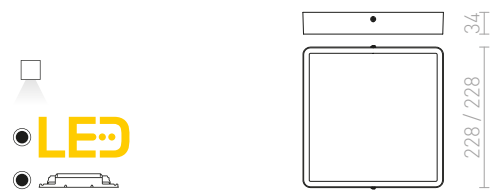



HUE

Luminária muito fina montada em superfície com LED de alta potência integrado. A moldura está disponível em cromo, cromo preto, níquel mate, laca branca e imitação de madeira. Regulação da intensidade da luz TRIAC.

HUE SQ 9 DIMM TETO

230 V LED 6 W 3000 K 540 lm Ra 80

R13142 branco	€ 58	→
R13143 cromo preto	€ 58	→
R13144 cromo	€ 58	→
R13145 níquel mate	€ 58	→
R13146 faixa decorativa	€ 58	→

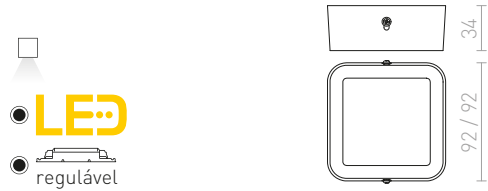

HUE SQ 17 DIMM DE TETO

230 V LED 18 W 3000 K 1620 lm Ra 80

R13083 branco	€ 120	→
R13084 cromo preto	€ 98	→
R13085 cromo	€ 120	→
R13086 níquel mate	€ 120	→
R13087 faixa decorativa	€ 120	→

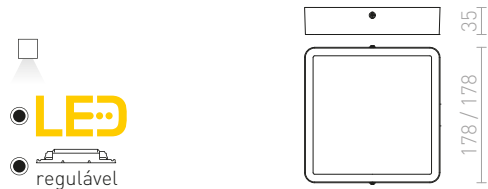

HUE SQ 22 DIMM DE TETO

230 V LED 24 W 3000 K 2160 lm Ra 80

R13088 branco	€ 138	→
R13089 cromo preto	€ 129	→
R13090 cromo	€ 138	→
R13091 níquel mate	€ 138	→

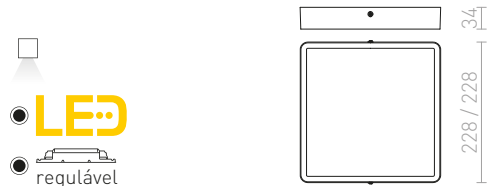







SEMPRE

Plafon com LED integrado e cobertura de acrílico fosco.

SEMPRE R 45 TETO

230 V LED 36 W 3000 K 2520 lm Ra 80

R12433 acrílico fosco

€ 120 ➤

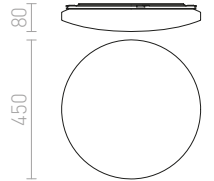
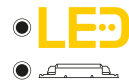

SEMPRE R 55 TETO

230 V LED 56 W 3000 K 3920 lm Ra 80

R12434 acrílico fosco

€ 178 ➤

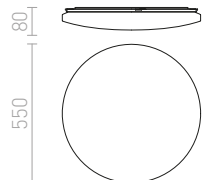

SEMPRE

Plafon com LED integrado e cobertura de acrílico fosco.

SEMPRE SQ 43 TETO

230 V LED 36 W 3000 K 2520 lm Ra 80

R12437 acrílico fosco

€ 98 ➤

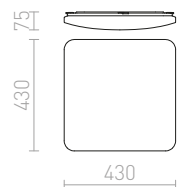

SEMPRE SQ 63 TETO

230 V LED 76 W 3000 K 5320 lm Ra 80

R12439 acrílico fosco

€ 220 ➤

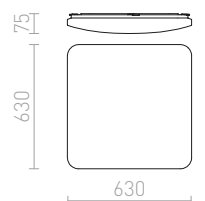



SEMPRE

Plafon com cobertura de acrílico fosco, LED e sensor de movimento incorporados.

SEMPRE SQ 33 SENSOR TETO

230 V LED 24 W 3000 K 1680 lm Ra 80

R12440 acrílico fosco

€ 120 →

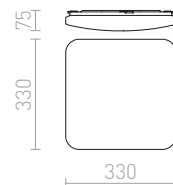

SEMPRE SQ 43 SENSOR TETO

230 V LED 36 W 3000 K 2520 lm Ra 80

R12441 acrílico fosco

€ 138 →

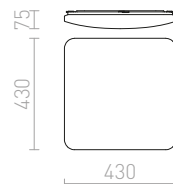

SEMPRE SQ 53 SENSOR TETO

230 V LED 56 W 3000 K 3920 lm Ra 80

R12442 acrílico fosco

€ 188 →

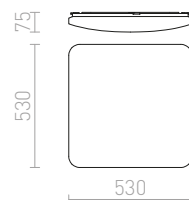

SEMPRE SQ 63 SENSOR TETO

230 V LED 76 W 3000 K 5320 lm Ra 80

R12443 acrílico fosco

€ 120 %

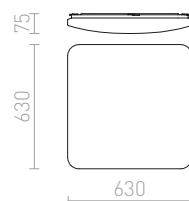





STRUCTURAL

Luminária LED montada em superfície com moldura em alumínio pintado. Inclui um driver incorporado.

STRUCTURAL LED 60x15 DE SUPERFÍCIE

230 V LED 22 W 3000 K 1370 lm Ra 80

R12064 branco

€ 158 %

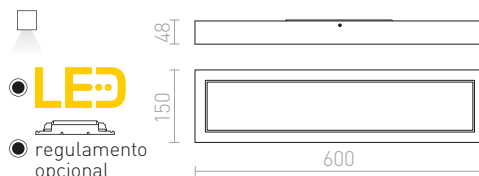

IP65



TRIDENT PRO

Luminária industrial linear LED para montagem em teto ou suspenso com kit G13672. Alto desempenho e proteção IP65. Fornecido sem kit de suspensão e cabo de alimentação. Possibilidade de ligação entre luminárias em série.

TRIDENT PRO 120 CORPO

230 V LED 40 W 4000 K 5200 lm Ra 80 IP65

G13670 cinzento/acrílico fosco

€ 68

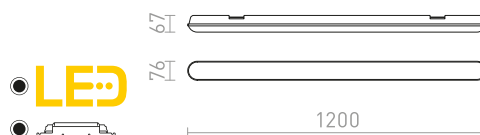

TRIDENT PRO 150 CORPO

230 V LED 60 W 4000 K 7800 lm Ra 80 IP65

G13671 cinzento/acrílico fosco

€ 88

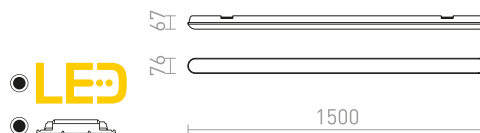



RIVIER

Luminária montada na superfície para fontes de luz fluorescentes T5, com cobertura de vidro transparente e base cromada.

RIVIER TETO

230 V G5 2x21 W

R10239 vidro transparente/cromo

€ 215 ➔

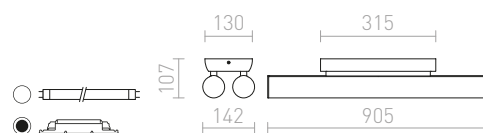

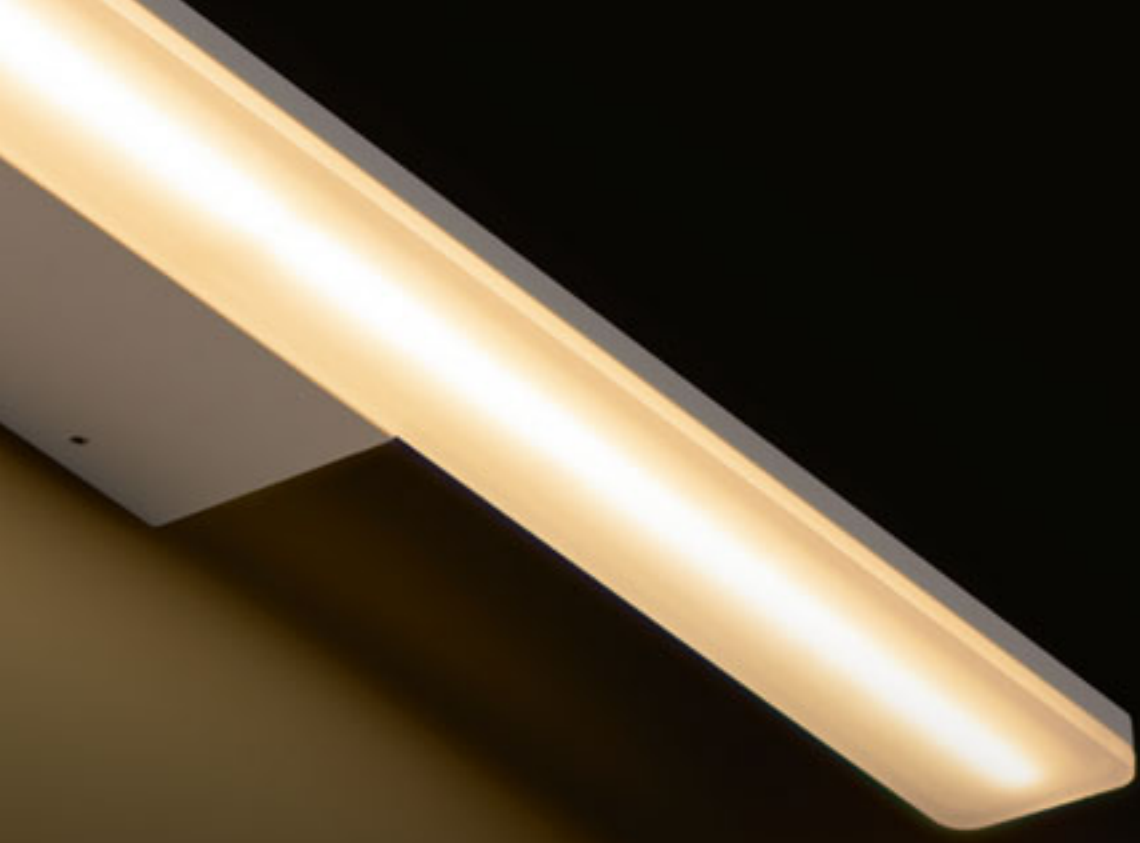

CANDEEIROS DE PAREDE

CASA DE BANHO	200-225
DECORATIVO	226-229
COMBINADO	230-233
COM UM BRAÇO	234-239
GESSO	240-251
INDIRETO	252-253
ACIMA - ABAIXO	254-269
POSICIONÁVEL	270-271
ILUMINAÇÃO DE ORIENTAÇÃO	272-275
SOBRE QUADROS	276-281
DEBAIXO DOS ARMÁRIOS	282-283

CANDEEIROS DE PAREDE

CASA DE BANHO



PANON SHORT
200-201



PANON LONG
200-201



SWAY
200-201

200-225



IMPERISO 60
200-201



PALEA 300
202-203



PALEA 500
202-203



MAREA 60
202-203

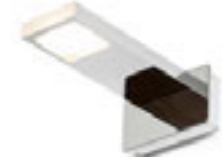

PARAGNA
202-203



YOLO SQ
204-205



PARIS
204-205



SAVOY 24
204-205



BALEA 500
204-205



LEVIA 60
206-207



LEVIA 90
206-207



LEVIA 120
206-207



AMENITY 60
208-209



AMENITY 90
208-209



AMENITY 120
208-209



PERISA 60
208-209



PERISA 90
208-209



IMPERIA 90
210-211



IMPERIA 120
210-211



ADAGIO 60
210-211



MARINA LED 60
212-213



MARINA LED 90
212-213



MARINA LED 120
212-213



MONET 84
214-215



LUISA 60
214-215



CASSAMBA 60
214-215



CRESCENDO 90
216-217



MIRANDA 60
216-217



MIRANDA 120
216-217



TAMPA 60
218-219



FLORIO 49
218-219



CORAZON 60
220-221



CORAZON 90
220-221



FAO 90
220-221



BOLLY III
222-223



LINN I
222-223



LINN III
222-223



VALTO I
222-223



VALTO III
222-223



DUBLIN I
224-225



DUBLIN II
224-225



DUBLIN III
224-225



DUBLIN IV
224-225

CANDEEIROS DE PAREDE DECORATIVO

226-229



RON W 15/25
226-227



LOPE W 25/14
226-227



PLAZA
228-229



PENTHOUSE
228-229



SELENA
228-229

CANDEEIROS DE PAREDE COMBINADO

230-233



VERSA
230-231



VERSINA
230-231



PERTH
230-231



TIARA
232-233



PLAZA
232-233



TAINA
232-233

CANDEEIROS DE PAREDE COM UM BRAÇO

234-239



JERSEY
234-235



SILENCE
234-235



SHARP
234-235



HUDSON
234-235



MADISON W
236-237



ASHLEY
236-237



MONTANA
238-239



ANTE
238-239

CANDEEIROS DE PAREDE GESSO

240-251



GINA S
240-241



CHIC
240-241



BODIE
240-241



BENITA
240-241



GRANITA II
240-241



GAN
242-243



VERITA
242-243



COWLEY
242-243



CRESCENT L
244-245



CRESCENT
244-245



SID
244-245



JACK RC LED W
246-247



JACK SQ
246-247



JACK RC S
246-247



ROLO 36
248-249



ROLO 45
248-249



WIM
248-249



HAY
250-251



TORO
250-251



KUBIS
250-251

CANDEEIROS DE PAREDE INDIRETO



FOND
252-253



BRUXEL 12
252-253



VIENNA
252-253

252-253



ATHI
252-253



ATLANTA 13
252-253

CANDEEIROS DE PAREDE ACIMA - ABAIXO



TITO R
254-255



TITO SQ
254-255



CARRE
254-255

254-269



TITO SQ
254-255



DAFFY
256-257



BIARITZ
256-257



TUBA W
256-257



MIDZACK
256-257



MICO I
258-259



MICO II
258-259



MOIRE I
258-259



MOIRE II
258-259



MARIO
260-261



REEM
260-261



ROZA
260-261



TAPA
260-261



NAXOS
260-261



TRIP SQ
262-263



ESSEX
262-263



ONYX
262-263



DIDO
262-263



CHLOE
264-265



LEA
264-265



TORINO
264-265



NEMAN
264-265



KORSO I
266-267



KORSO II
266-267



PEKKO
266-267



NOZ LED
266-267



AGATE II
268-269



DESMOND II
268-269



NICK II
268-269



UKKO
268-269

CANDEEIROS DE PAREDE POSICIONÁVEL

270-271

TWIST
270-271

AQUE
270-271

CANDEEIROS DE PAREDE ILUMINAÇÃO DE ORIENTAÇÃO

272-275

AQILA R
272-273

AQILA SQ
272-273

AQILA RC
272-273

AMBER
272-273

TICO I
272-273

BOBO R
274-275

BOBO SQ
274-275

BOBO RC
274-275

CANDEEIROS DE PAREDE SOBRE QUADROS

276-281

PRIO LED 38, 62
276-277

RIVIER
276-277

SWING
278-279

SWAY
278-279

PANON LONG
278-279

IMPERISO 60
280-281

MAREA 60
280-281

LUISA 60
280-281

CANDEEIROS DE PAREDE DEBAIXO DOS ARMÁRIOS

282-283

FLORIO 49
282-283

CORAZON 60
282-283

CORAZON 90
282-283



IP44



IP44

PANON

Luminária LED linear com base central. Adequada para uso em ambientes húmidos.

PANON SHORT NA PAREDE

230 V LED 18 W 3000 K 1700 lm Ra 80 IP44

R12949 cromo

€ 150

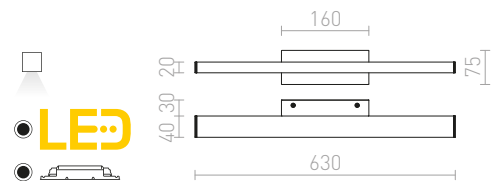

PANON LONG NA PAREDE

230 V LED 12 W 3000 K 900 lm Ra 80 IP44

R12950 cromo

€ 129

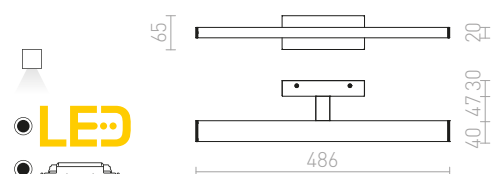



IP44

SWAY

Luminária LED linear inclinável, ideal acima de espelhos ou quadros.

SWAY CASA DE BANHO

230 V LED 12 W 3000 K 1060 lm Ra 80 IP44

R12951 cromo

€ 120

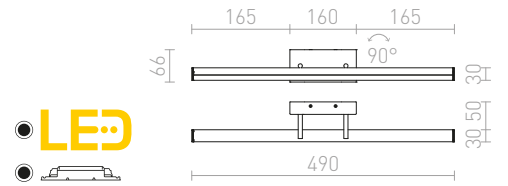

IP44

IMPERISO

Luminária linear LED adequada para colocar acima de espelho. A frente pode girar no eixo horizontal. Para uso em ambientes húmidos.

IMPERISO 60

230 V LED 18 W 3000 K 1769 lm Ra 80 IP44

R13555 branco

€ 248

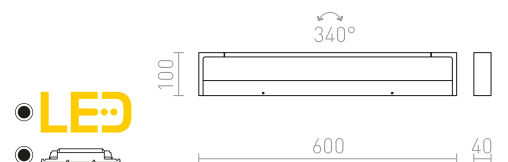



IP44

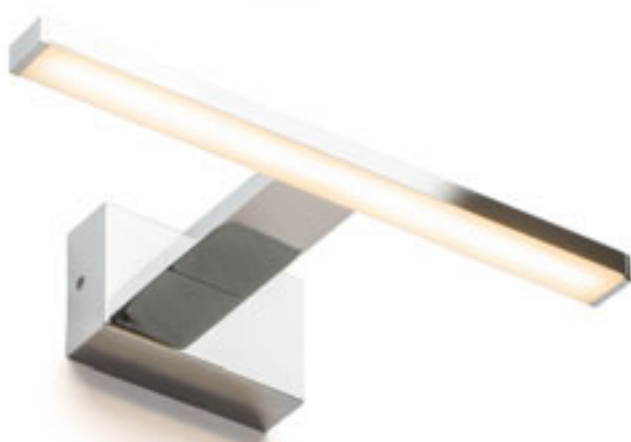

IP44



IP44

PALEA

Luminária de parede para casa de banho com tecnologia LED. Adequada para uso em ambientes húmidos.

PALEA 500

230 V LED 7 W 3000 K 308 lm Ra 80 IP44

R10613 cromo

€ 178

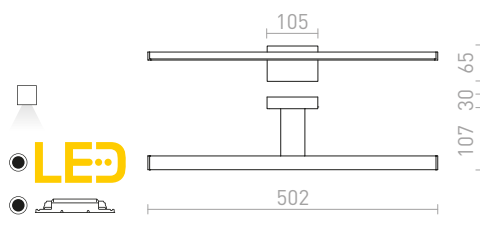

PALEA 300

230 V LED 4,4 W 3000 K 189 lm Ra 80 IP44

R10614 cromo

€ 129

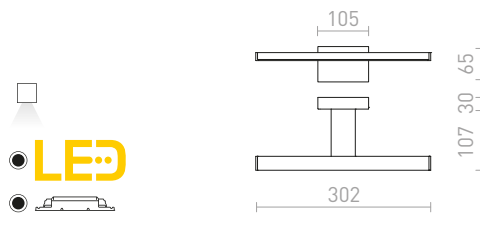

PARAGNA

Luminária de parede de casa de banho com tecnologia LED.

PARAGNA NA PAREDE

230 V LED 5,7 W 3000 K 246 lm Ra 80 IP44

R10612 cromo

€ 88

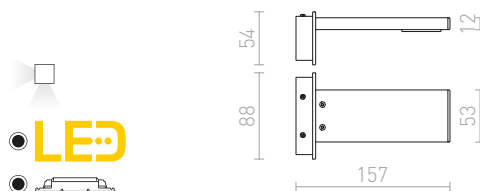



IP44

MAREA

Luminária linear LED com iluminação descendente, adequada para colocar acima do espelho. Para uso em ambientes húmidos.

MAREA 60 NA PAREDE

230 V LED 18 W 3000 K 1954 lm Ra 80 IP44

R13554 branco

€ 198

R13852 preto

€ 198

NEW

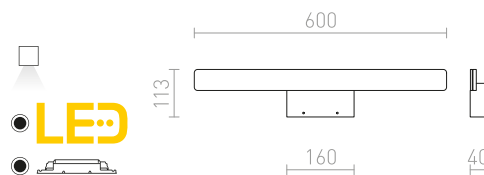

IP44

PARIS

Luz para casa de banho com LED integrado de metal sólido cromado adequada para armários e prateleiras.

PARIS PARA ARMÁRIOS

230 V LED 3 W $\angle 120^\circ$ 3000 K 210 lm Ra 80 IP44

R12398 cromo

€ 78 %

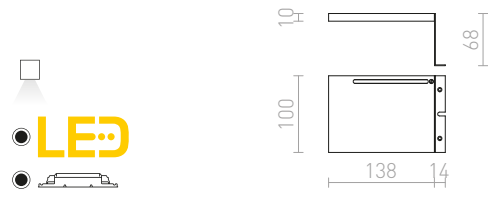

IP44

SAVOY

Luz retangular de metal cromado para casa de banho com iluminação bidirecional adequada para armários e prateleiras.

SAVOY 24 PARA ARMÁRIOS

230 V LED 8 W $\angle 120^\circ$ 3000 K 300 lm Ra 80 IP44

R12399 cromo

€ 98 %

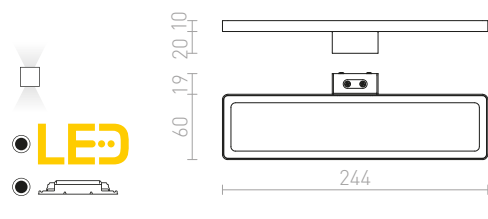

IP44

BALEA

Luminária linear para casa de banho com LED integrado e um braço para montagem em gabinetes ou prateleiras.

BALEA 500 PARA ARMÁRIOS

230 V LED 7 W $\angle 120^\circ$ 3000 K 370 lm Ra 80 IP44

R12400 cromo

€ 120

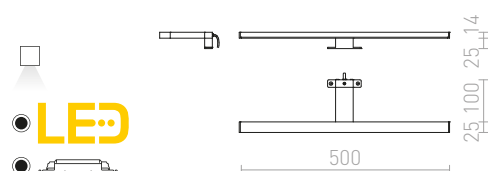



IP44



YOLO

Luz para casa de banho com LED integrado que pode ser montada em armários ou espelhos.

YOLO SQ ACIMA DE ESPELHO
12 V= LED 4 W 3000 K 215 lm Ra 80 IP44

R10588 cromo

€ 48 %

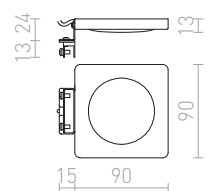
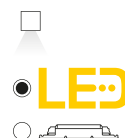



LEVIA

Luminária LED de parede linear. Adequada para ambientes húmidos. A luz pode ser montada em armários ou prateleiras usando o conjunto de suportes R12581.

LEVIA 60 NA PAREDE

230 V LED 12 W $\angle 120^\circ$ 3000 K 900 lm Ra 80 IP44

R12401 alumínio

€ 150

R12402 cromo

€ 158

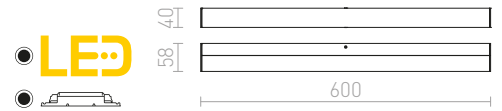

IP44

LEVIA 90 NA PAREDE

230 V LED 18 W $\angle 120^\circ$ 3000 K 1300 lm Ra 80 IP44

R12403 alumínio

€ 215

R12404 cromo

€ 215



IP44

LEVIA 120 NA PAREDE

230 V LED 24 W $\angle 120^\circ$ 3000 K 1700 lm Ra 80 IP44

R12405 alumínio

€ 258

R12406 cromo

€ 268

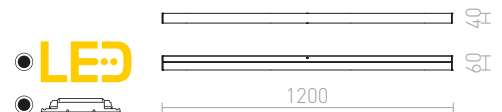

IP44

LEVIA

Suportes cromados para montagem em armários de R102401, R12402, R12403, R12404, R12405 e R12406.

LEVIA CONJUNTO DE ALÇAS EM ARMÁRIO

R12581 cromo

€ 3.80

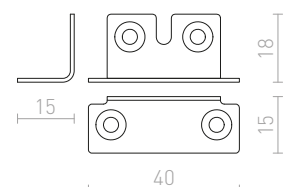



IP44



IP44

PERISA

Luminária linear para tubos fluorescentes ideal acima de espelhos. Disponível em alumínio ou lacada de branco. Adequada para ambientes húmidos.

PERISA 60 NA PAREDE

230 V G5 14 W IP44

R10262 branco

€ 120

%

R10264 alumínio escovado

€ 120

%



PERISA 90 NA PAREDE

230 V G5 21 W IP44

R10263 branco

€ 88

%

R10265 alumínio escovado

€ 120

%

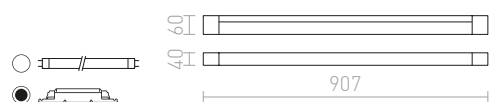



IP44



IP44



IP44



AMENITY

Luminária de parede linear com LED integrado e pontas cromadas. Adequada para ambientes húmidos.

AMENITY 120 NA PAREDE

230 V LED 14 W 3000 K 830 lm Ra 80 IP44

R12641 cromo

€ 229

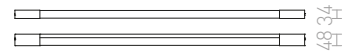

AMENITY 90 NA PAREDE

230 V LED 11 W 3000 K 580 lm Ra 80 IP44

R12640 cromo

€ 238

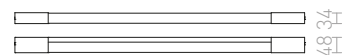

AMENITY 60 NA PAREDE

230 V LED 8 W 3000 K 400 lm Ra 80 IP44

R12639 cromo

€ 188

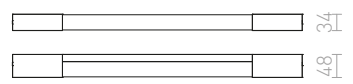





IP44

ADAGIO

Luminária angular sólida com difusor de plástico e acessórios cromados, adequada para ambientes húmidos.

ADAGIO 60 NA PAREDE

230 V G5 24 W IP44

R12217 cromo

€ 138 ➔

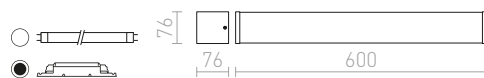

IP44

IMPERIA

Luminária retangular para casa de banho com cobertura de plástico e acessórios cromados.

IMPERIA 120 NA PAREDE

230 V G5 28 W IP44

R12219 cromo

€ 178 %



IP44

IMPERIA 90 NA PAREDE

230 V G5 39 W IP44

R12218 cromo

€ 158 %



IP44



IP44



IP44

MARINA

Luminária linear montada na parede com LED integrado para iluminação bidirecional. Adequada para ambientes húmidos.

MARINA LED 60 NA PAREDE

230 V LED 14 W 3000 K 550 lm Ra 80 [IP44](#)

R11993 cromo

€ 188



45



80



600

MARINA LED 90 NA PAREDE

230 V LED 19 W 3000 K 800 lm Ra 80 [IP44](#)

R11996 cromo

€ 248



45



80



900

MARINA LED 120 NA PAREDE

230 V LED 25 W 3000 K 950 lm Ra 80 [IP44](#)

R11998 cromo

€ 380



45



80



1200





IP44



MONET

Luminária linear de LED acima de espelho, adequada para áreas húmidas.

MONET 84 NA PAREDE

230 V LED 29 W 3000 K 1892 lm Ra 80 IP44

R13337 acrílico fosco/cromo

€ 290 %



LED

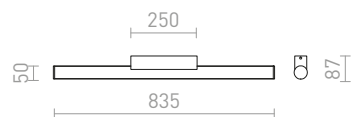



IP54



IP44

LUISA

Luminária linear LED com iluminação descendente, adequada para colocar acima do espelho. Para uso em ambientes húmidos.

LUISA 60 NA PAREDE

230 V LED 12 W 3000 K 1138 lm Ra 80 IP54

R13735 branco

€ 150

NEW

R13853 preto

€ 138

NEW

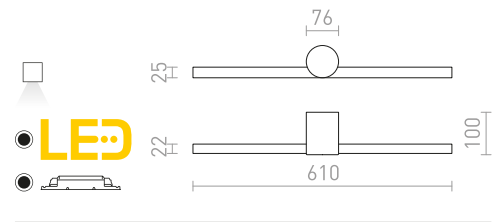

CASSAMBA

Candeeiro de parede em forma de tubo com LED incorporado numa base oblonga, adequado para casas de banho. A temperatura de cor da luz pode ser alterada usando um interruptor no interior da base: 3000K ou 4000K.

CASSAMBA 60 NA PAREDE

230 V LED 12 W 3000 K 4000 K 700 lm Ra 80 IP44

R13888 preto/acrílico fosco

€ 178

NEW

R13889 cromo/acrílico fosco

€ 178

NEW

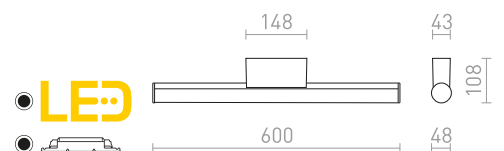





IP44

IP44



IP44

MIRANDA

Luminária linear com LED integrado adequada para ambientes húmidos.

MIRANDA 60 NA PAREDE

230 V LED 8 W 3000 K 470 lm Ra 80 IP44

R12407 cromo

€ 178

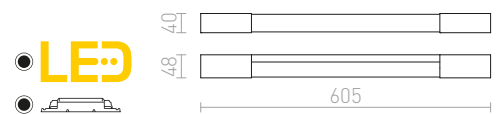

MIRANDA 120 NA PAREDE

230 V LED 14 W 3000 K 1000 lm Ra 80 IP44

R12409 cromo

€ 258



CRESCENDO

Luminária para casa de banho com cobertura redonda de plástico e acessórios cromados. Ideal acima de espelhos. Pode ser instalado em ambientes húmidos.

CRESCENDO 90 NA PAREDE

230 V G5 39 W IP44

R12220 cromo

€ 178





IP44



FLORIO

Luminária LED indicada para casa de banho, com ficha integrada para aparelhos de baixo consumo até 100W.

FLORIO 49 PAREDE

230 V LED 8 W 3000 K 640 lm Ra 80 IP44

R12903 branco

€ 88

R12904 cromo

€ 98

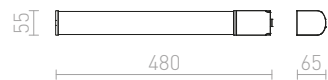

IP44

TAMPA

Luminária linear para casa de banho com LED integrado, ideal acima de espelhos, com opção de comprar terminais em diferentes cores (R12906, R12907, R12908).

TAMPA 60 NA PAREDE SEM TERMINAIS

230 V LED 15 W 3000 K 1400 lm Ra 80 IP44

R12905 branco

€ 68



TAMPA

Terminais em separado disponíveis em três cores para uso com R12905.

TAMPA TERMINAIS 2 PÇS

R12906 branco

€ 2

R12907 cinzento prata

€ 4.80

R12908 cromo

€ 6

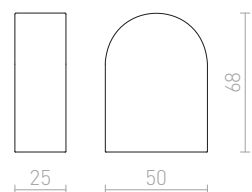







IP44

FAO

Luminária linear montada em superfície com cobertura de acrílico fosco para ambientes húmidos.

FAO 90 NA PAREDE

230 V G5 21 W IP44

R10491 cromo

€ 120

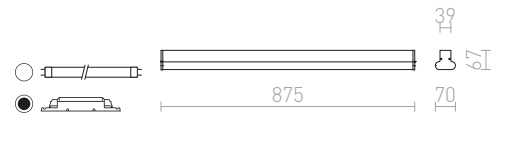

IP44

CORAZON

Luminária linear com LED integrado, adequada para ambientes húmidos.

CORAZON 60

230 V LED 15 W 3000 K 1200 lm Ra 80 IP44

R12901 cromo

€ 78

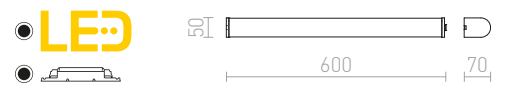

IP44

CORAZON 90

230 V LED 20 W 3000 K 1600 lm Ra 80 IP44

R12902 cromo

€ 120





IP44



IP44

LINN

Candeeiro de parede ou teto com vidro opalino e base cromada. Adequado para casas de banho.

LINN III DE SUPERFÍCIE

230 V G9 LED 3x3 W IP44

R13703 vidro colorido opala/cromo

€ 120

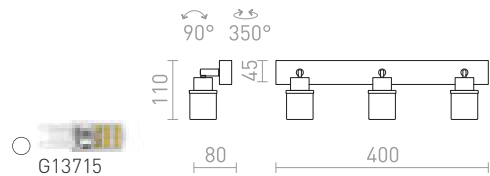

LINN I NA PAREDE

230 V G9 LED 3 W IP44

R13695 vidro colorido opala/cromo

€ 48

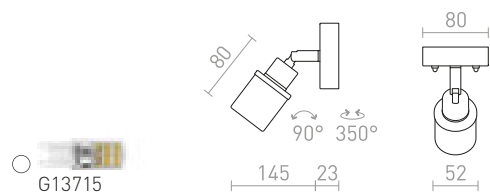



IP44



BOLLY

Luminária de parede ou teto com vidro opalino sobre base cromada. Adequado para ambientes húmidos.

BOLLY III DE SUPERFÍCIE

230 V G9 LED 3x3 W IP44

R13691 vidro colorido opala/cromo

€ 138

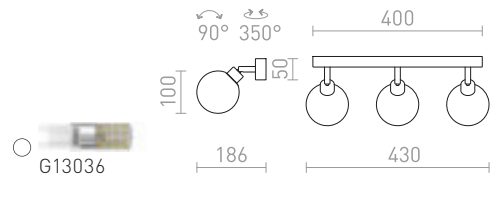

IP44

VALTO

Luminária de parede ou teto com refletores inclináveis para fontes de luz LED com casquilho GU10. Adequado para casas de banho.

VALTO III DE SUPERFÍCIE

230 V GU10 LED 3x5 W IP44

R13704 cromo

€ 98

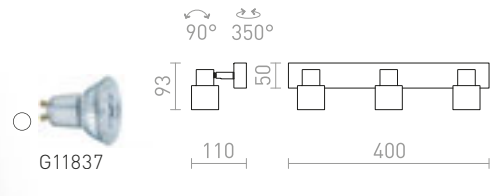

IP44

VALTO I NA PAREDE

230 V GU10 LED 5 W IP44

R13696 cromo

€ 48

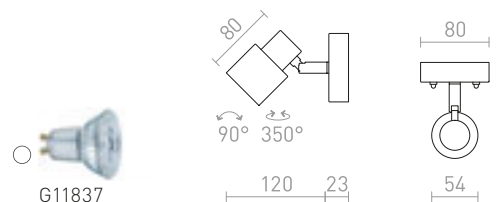





IP44

DUBLIN

Foco cromado adequado para casas de banho.

DUBLIN I DE SUPERFÍCIE

230 V GU10 9 W IP44

R13377 cromo

€ 48

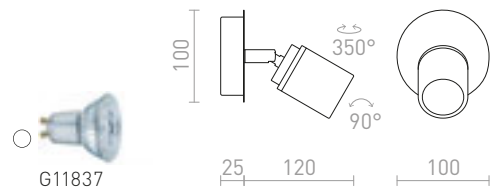

IP44

DUBLIN II DE SUPERFÍCIE

230 V GU10 2x9 W IP44

R13378 cromo

€ 88

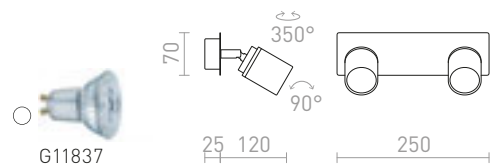

IP44

DUBLIN III DE SUPERFÍCIE

230 V GU10 3x9 W IP44

R13379 cromo

€ 120

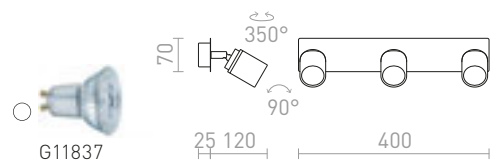

IP44

DUBLIN IV DE SUPERFÍCIE

230 V GU10 4x9 W IP44

R13380 cromo

€ 150

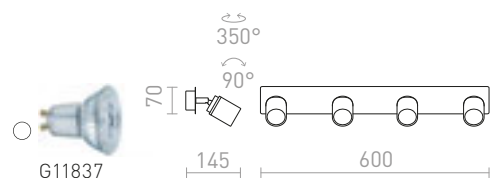



RON

Luminária de parede com abajur têxtil.

RON W 15/25 NA PAREDE

230 V E27 28 W

	R11368 Poli-algodão preto/folha de cobre	€ 150
	R11464 Poli-algodão preto/folha dourada	€ 150
	R11492 Poli-algodão branco/PVC branco	€ 120
	R11509 Alperce de Chintz/PVC branco	€ 120
	R11519 Chintz laranja/PVC branco	€ 120
	R11548 Chintz menta/folha de prata	€ 129
	R11557 Chintz cinza claro/PVC branco	€ 120
	R11567 Chintz limão/PVC branco	€ 120
	R11575 monaco gasolina azul/prata PVC	€ 129
	R11586 monaco pomba gris/prata PVC	€ 129

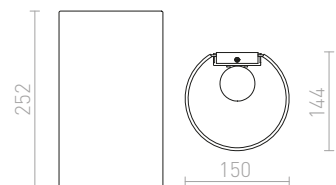



LOPE

Luminária de parede com abajur têxtil.

LOPE W 25/14 NA PAREDE

230 V E27 28 W

	R11365 Poli-algodão preto/folha dourada	€ 150
	R11377 Poli-algodão preto/folha de cobre	€ 150
	R11381 Chintz azeitona/folha de prata	€ 98 %
	R11383 Chintz menta/folha de prata	€ 150
	R11504 Poli-algodão branco/PVC branco	€ 120
	R11512 Alperce de Chintz/PVC branco	€ 120
	R11522 Chintz laranja/PVC branco	€ 120
	R11560 Chintz cinza claro/PVC branco	€ 120
	R11570 Chintz limão/PVC branco	€ 120

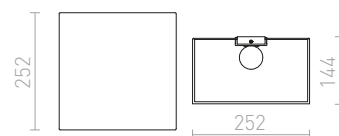



SELENA

Candeeiro de parede em tecido com interruptor de puxar. O abajur pode ser girado sobre um eixo.

SELENA NA PAREDE

230 V E27 15 W

R13651 preto

€ 120 ➔



G13014

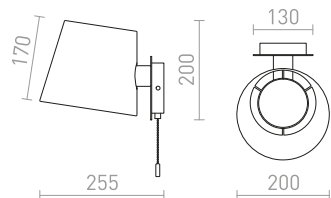



PENTHOUSE

Luminária de parede com abajur de plástico e base cromada.

PENTHOUSE NA PAREDE

230 V E27 42 W

R11979 PVC branco/cromo

€ 129 %

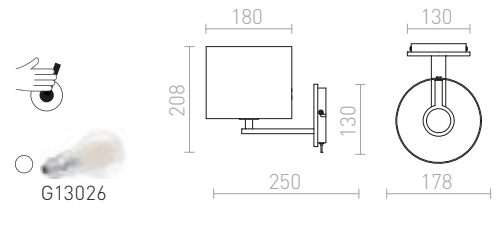

PLAZA

Luminária de parede com abajur têxtil texturado.

PLAZA NA PAREDE

230 V E27 42 W

R11981 branco/cromo

€ 129 ➔

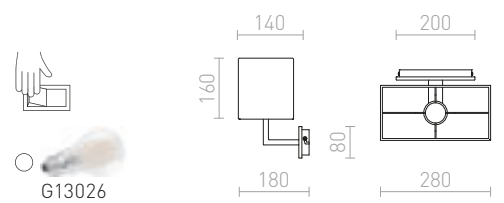



VERSA

Luminária LED de parede com abajur têxtil e foco adicional com braço flexível. As duas fontes de luz podem funcionar separadamente com interruptores localizados na base.

VERSA PAREDE COM ABAJUR

230 V E27 LED 42 W + 3 W $\angle 40^\circ$ 3000 K 240 lm Ra 80

R10580 branco/níquel mate

€ 188



G13026

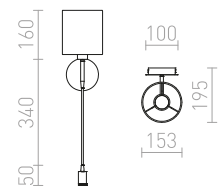

VERSINA

Luminária de parede com abajur têxtil, complementada com foco LED sobre braço flexível. As duas fontes de luz podem funcionar separadamente com interruptores colocados na base.

VERSINA COM ABAJUR

230 V E27 LED 28 W + 3 W $\angle 25^\circ$ 3000 K 180 lm Ra 80

R12955 branco/cromo

€ 138



G13026

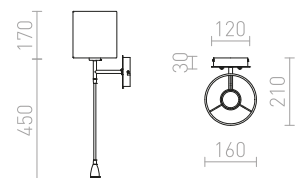

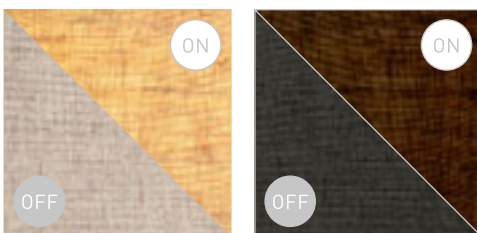

PERTH

Candeeiro de parede com abajur quadrado em tecido complementado por braço flexível com refletor LED. O candeeiro possui duas fontes de luz, que podem ser controladas separadamente por um interruptor rotativo localizado na base quadrada do candeeiro.

PERTH NA PAREDE COM FOCO LED

230 V E14 LED 15 W + 3 W $\angle 30^\circ$ 3000 K 150 lm Ra 80

R13661 bege/branco/cromo € 178

R13662 preto/preto/cromo € 178

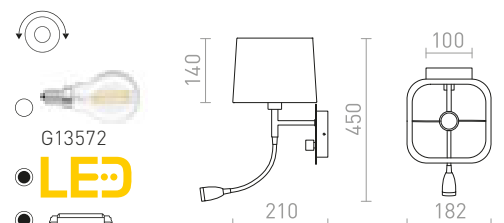



PLAZA

Luminária de parede com abajur têxtil texturado para fontes de luz E27 e LED 3W para leitura. Ambas as fontes de luz são controladas separadamente por um interruptor na base.

PLAZA NA PAREDE COM SPOT LED

230 V E27 LED 42 W + 3 W 3000 K 140 lm Ra 80

R11982 branco/cromo

€ 215



G13026

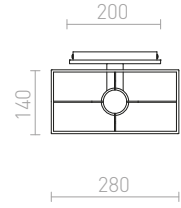
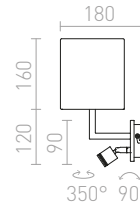

TIARA

Luminária de parede LED com refletor e iluminação indireta superior. Possui duas fontes de luz que podem ser controladas separadamente por interruptores localizados na base da luminária.

TIARA NA PAREDE

230 V LED 2x3 W $\angle 25^\circ$ 3000 K 300 lm Ra 80

R12957 cromo

€ 78

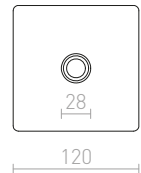
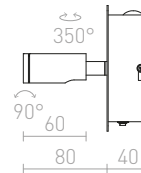
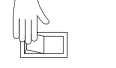

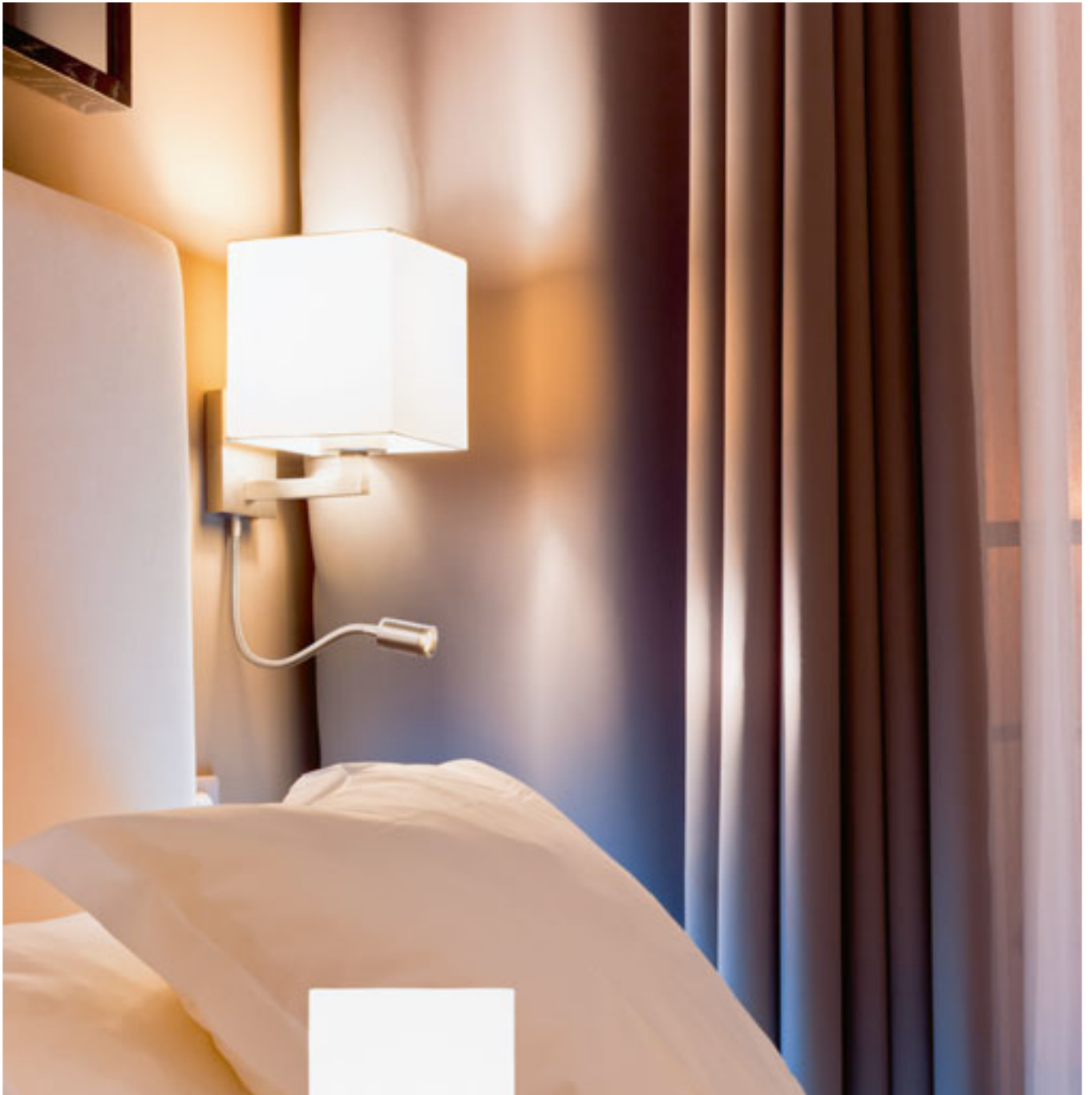

TAINA

Luminária de parede com abajur têxtil com LED sobre braço flexível. As duas fontes de luz podem ser controladas individualmente por interruptores localizados na base da luminária.

TAINA COM ABAJUR

230 V E27 LED 28 W+3 W $\angle 25^\circ$ 3000 K 180 lm Ra 80

R12956 branco/níquel mate

€ 150

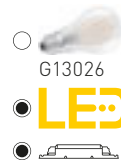

G13026

LED

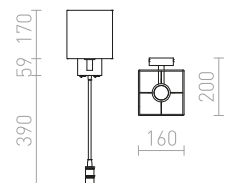



HUDSON

Luminária de parede com braço cromado, cabo vertical e abajur cilíndrico têxtil.

HUDSON NA PAREDE

230 V E27 28 W

R13284 branco/cromo

€ 150

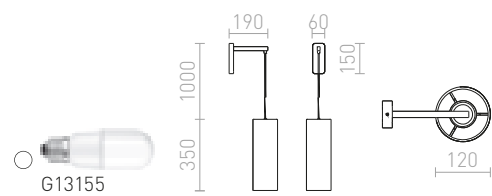



SHARP

Luminária de parede com abajur têxtil e interruptor na base.

SHARP NA PAREDE

230 V E27 42 W

R12481 preto/cromo

€ 120 %

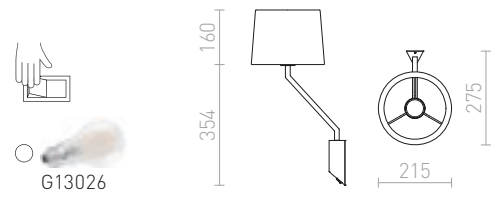

SILENCE

Luminária de parede com abajur de tecido texturado direcional.

SILENCE NA PAREDE

230 V E27 42 W

R11975 branco/cromo

€ 120 %

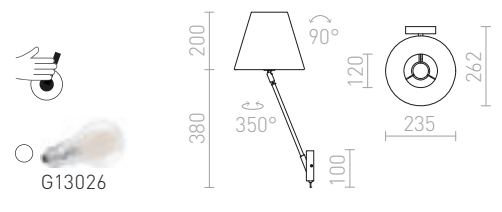

JERSEY

Luminária de parede elegante inclinável. O abajur é coberto com tecido texturado.

JERSEY NA PAREDE

230 V E27 42 W

R11976 branco/cromo

€ 178

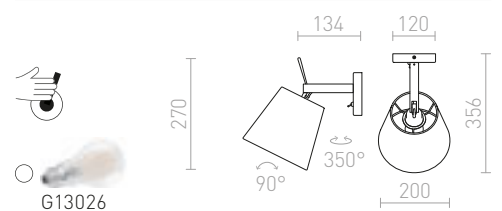



MADISON

Luminária de teto com braço ajustável e um abajur têxtil.

MADISON W NA PAREDE

230 V E27 42 W

R12480 branco/cromo

€ 480

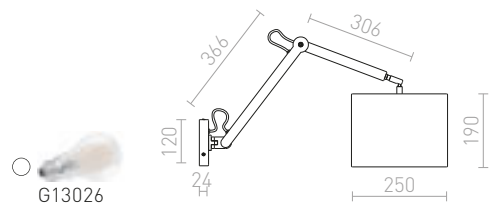

ASHLEY

Luminária de parede com braço duplo, abajur têxtil e interruptor na base.

ASHLEY NA PAREDE

230 V E27 42 W

R12482 branco/cromo

€ 460

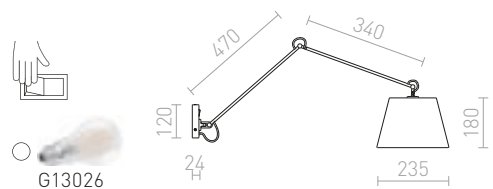







MONTANA

Candeeiro de parede com braço ajustável e abajur têxtil.

MONTANA NA PAREDE

230 V E27 28 W

R13282 branco/preto/cromo

€ 290



G13014

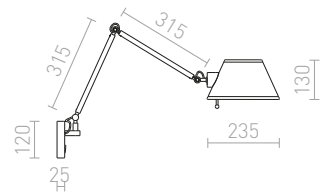

ANTE

Candeeiro de parede, ideal para escritório, com braço ajustável e interruptor na base.

ANTE NA PAREDE

230 V E27 28 W

R12651 preto/cobre

€ 120

R12652 branco/níquel mate

€ 120



G13026

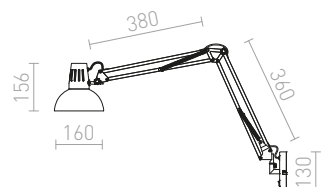



IP65

GRANITA

Candeeiro em cimento de parede, para exterior e fontes de luz LED com casquilho GU10.

GRANITA II NA PAREDE

230 V LED GU10 2x5 W IP65

R13792 cimento/granito claro

€ 120 **NEW**

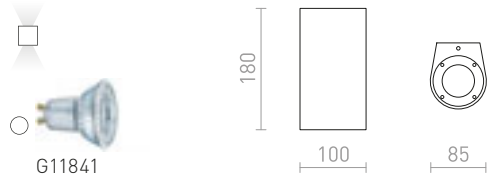

GINA

Luminária de parede em gesso para fontes de luz com casquilho G9. A superfície pode ser pintada com tintas para interiores.

GINA S PAREDE

230 V G9 33 W

R11959 gesso

€ 58

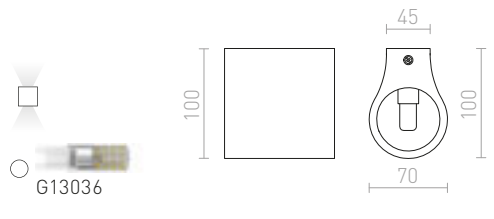

CHIC

Aplique de gesso para iluminação bidirecional. A superfície pode ser pintada com tintas para interiores.

CHIC NA PAREDE

230 V G9 25 W

R12999 gesso

€ 58

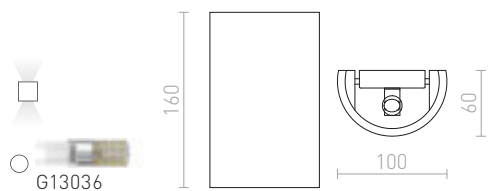



BENITA

Aplique de gesso para fontes de luz E14. A superfície pode ser pintada com tinta de parede convencional.

BENITA NA PAREDE

230 V E14 25 W

R13520 gesso

€ 88

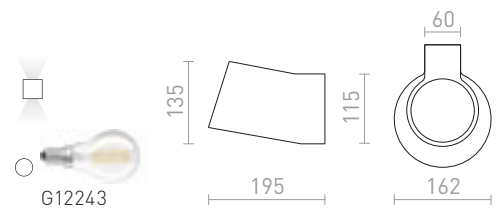

BODIE

Luminária com LED integrado para iluminação bidirecional. A superfície pode ser pintada com tintas para interiores. Inclui um driver embutido.

BODIE NA PAREDE

230 V LED 2x3 W 3000 K 480 lm Ra 80

R13433 gesso

€ 120

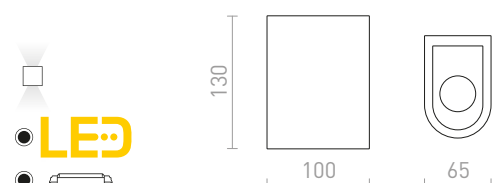



GAN

Luminária de gesso de parede com iluminação bidirecional. A superfície pode ser pintada com tintas para interiores.

GAN NA PAREDE

230 V G9 33 W

R12039 gesso

€ 78

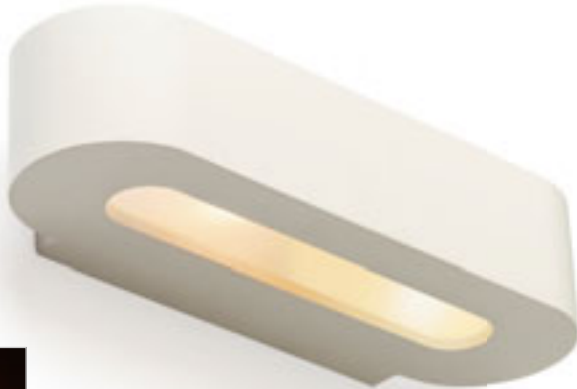
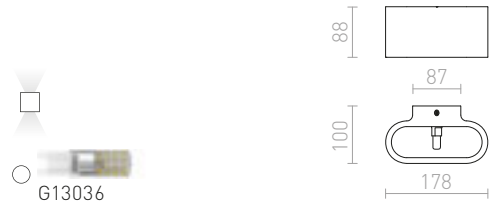

COWLEY

Luminária de gesso de parede com iluminação bidirecional. A parte inferior tem uma cobertura de vidro acetinado. A superfície pode ser pintada com tintas para interiores.

COWLEY NA PAREDE

230 V G9 2x28 W

R13435 gesso

€ 98

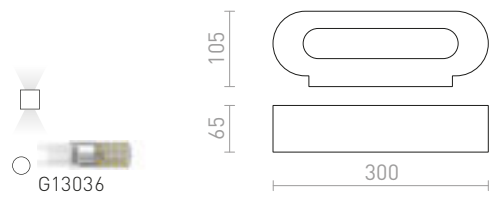

VERITA

Luminária de gesso redonda com luz bidirecional e fonte de luz E27. A superfície pode ser pintada com tintas para interiores.

VERITA NA PAREDE

230 V E27 33 W

R12365 gesso

€ 120







CRESCENT

Aplique de gesso com iluminação bidirecional. O fundo tem uma cobertura de vidro acetinado. A superfície pode ser pintada com tintas para interiores.

CRESCENT L NA PAREDE

230 V E14 2x28 W

R10451 gesso

€ 138

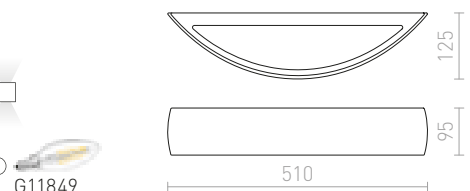

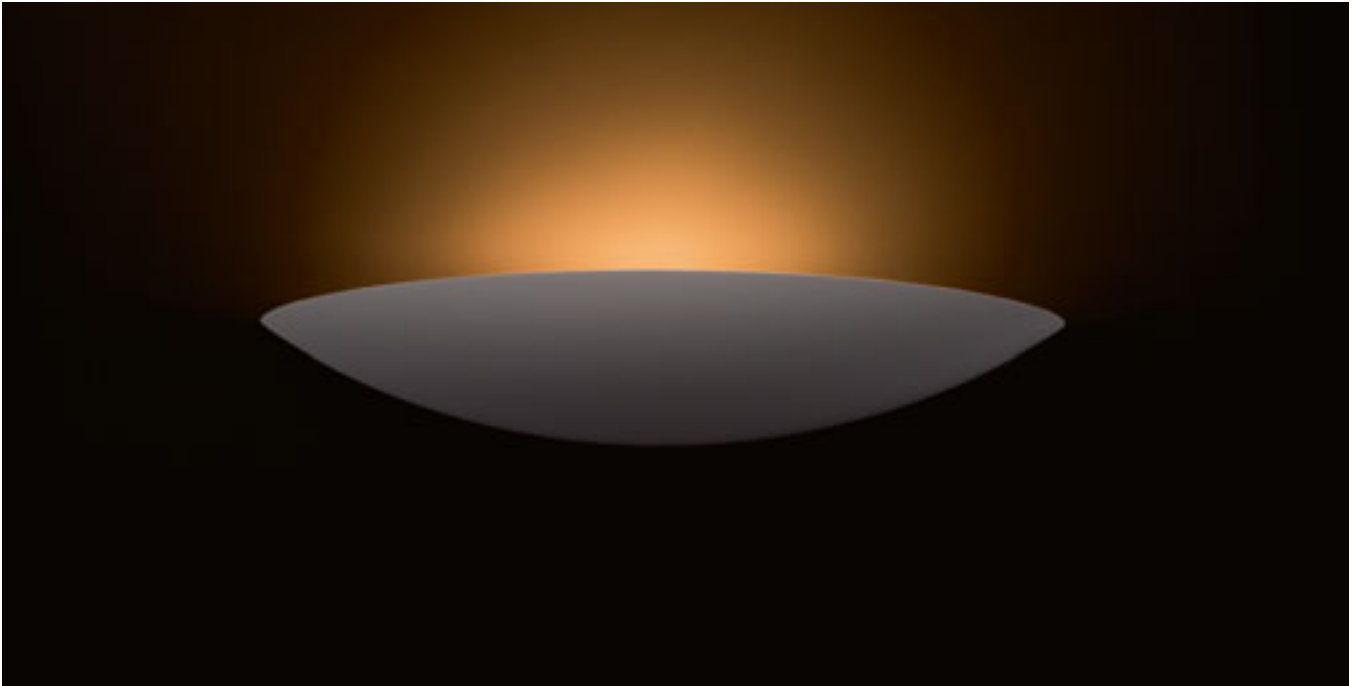

SID

Luminária de gesso para iluminação indireta. A luminária pode ser pintada com tintas para interiores.

SID NA PAREDE

230 V R7s 78mm 48 W

R12998 gesso

€ 88

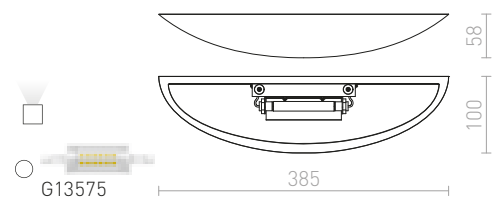

CRESCENT

Aplique de gesso com iluminação bidirecional. O fundo tem cobertura de vidro acetinado. Para uma fonte de luz de halógeno linear de 78 mm. A superfície pode ser pintada com tintas para interiores.

CRESCENT NA PAREDE

230 V R7s 78mm 80 W

R10266 gesso

€ 88

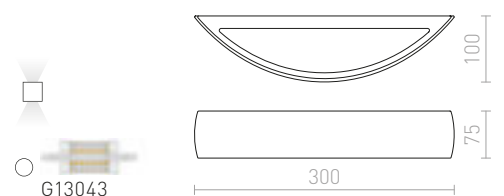



JACK

Luminária de parede em gesso bidirecional.
A superfície pode ser pintada com tintas para interiores.

JACK SQ NA PAREDE

230 V G9 40 W

R10445 gesso

€ 58

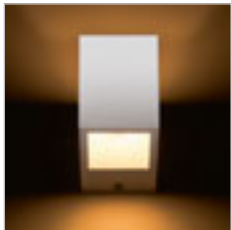
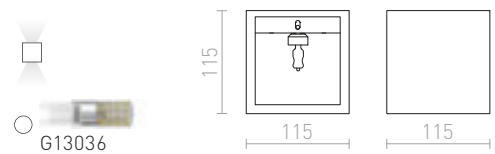

JACK RC S NA PAREDE

230 V G9 33 W

R11960 gesso

€ 48

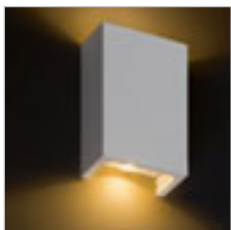
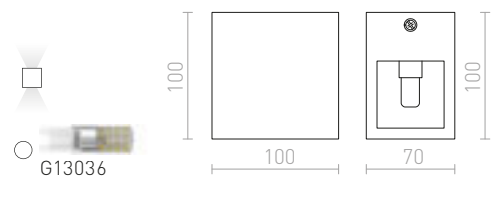

JACK

Luminária de parede em gesso bidirecional.
A superfície pode ser pintada com tintas para interiores.

JACK RC LED W NA PAREDE

230 V LED 2x3 W 3000 K 300 lm Ra 80

R12036 gesso

€ 129 →

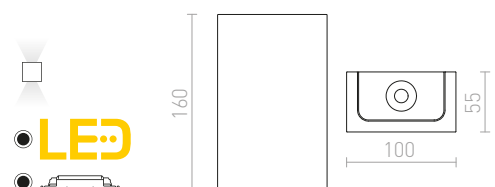



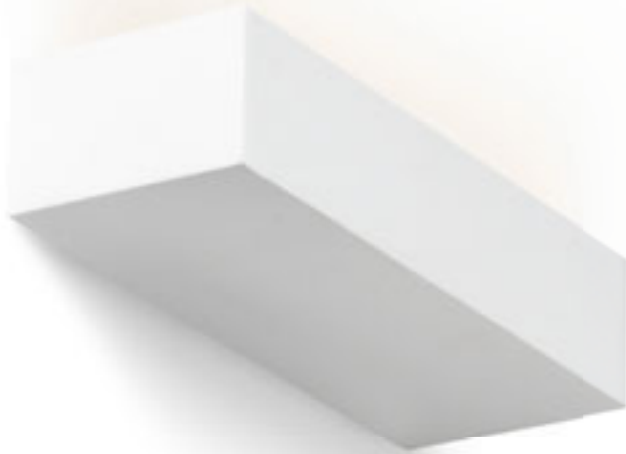

WIM

Aplique em gesso que pode ser pintado com tintas para interiores.

WIM NA PAREDE

230 V G9 2x40 W

R10465 gesso

€ 68

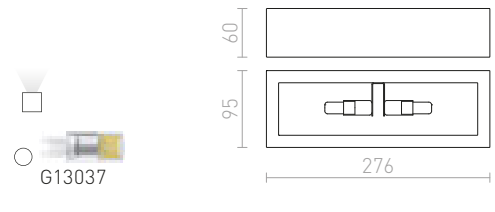

ROLO

Luminária bidirecional de gesso. A parte inferior tem uma cobertura de vidro acetinado. A superfície pode ser pintada com tintas para interiores.

ROLO 45 NA PAREDE

230 V E14 2x11 W

R13436 gesso

€ 120

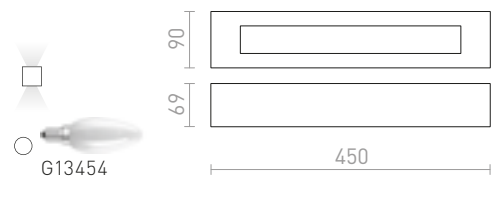

ROLO 36 NA PAREDE

230 V E14 2x30 W

R10446 gesso

€ 78

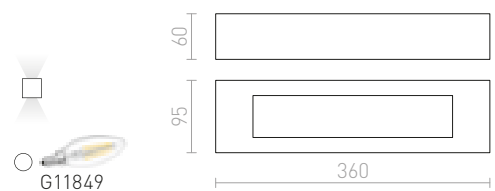







KUBIS

Luminária de parede em gesso com forma assimétrica. Deve ser instalada com a abertura estreita apontando para cima. A superfície pode ser pintada com tinta de parede convencional. Dimensões da base A/L/P 10/5/2 cm, dimensões das aberturas D1/A1 10/5.5 cm, A2/L2 7/8 cm.

KUBIS NA PAREDE

230 V G9 40 W

R10455 gesso

€ 58

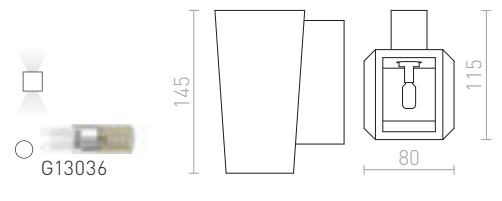

TORO

Aplique em gesso. A superfície pode ser pintada com tintas para interiores.

TORO NA PAREDE

230 V G9 2x40 W

R10449 gesso

€ 129

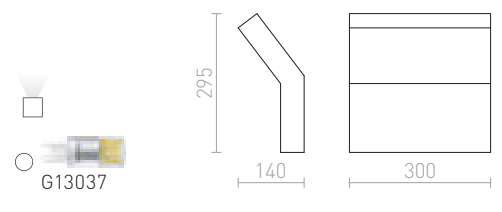

HAY

Aplique em gesso. A superfície pode ser pintada com tintas para interiores.

HAY NA PAREDE

230 V G9 40 W

R10448 gesso

€ 48

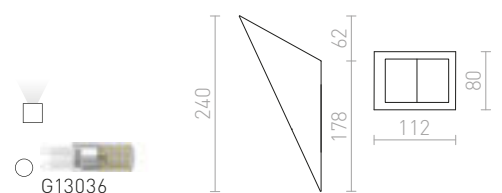



FOND

Aplique retangular com LED integrado para iluminação indireta.

FOND NA PAREDE

230 V LED 12 W 3000 K 1300 lm Ra 80

R12596 branco

€ 120

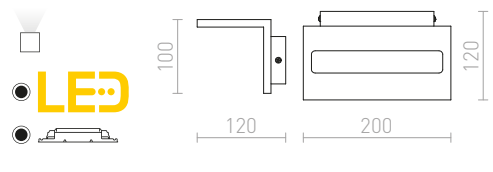

BRUXEL

Luz montada na parede com design elegante e LED integrado para iluminação indireta.

BRUXEL 12 NA PAREDE

230 V LED 6 W 3000 K Ra 80

R13842 branco

€ 88

NEW

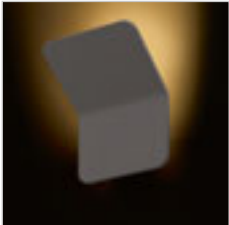
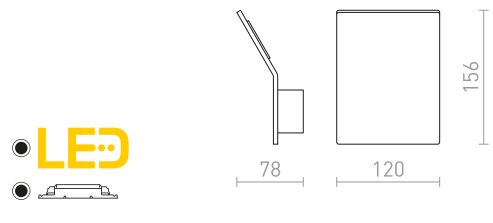

ATLANTA

Luminária de parede circular com LED integrado para iluminação indireta que reflete a luz da parede. Adequada para uso interior e exterior.

ATLANTA 13 DE SUPERFÍCIE

230 V LED 6 W 3000 K 780 lm Ra 80 IP54

R12825 branco

€ 78

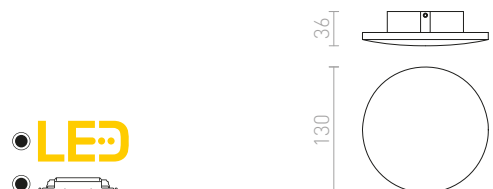



VIENNA

Luminária LED de parede quadrada com cantos arredondados e LED integrado para iluminação indireta refletindo a luz da parede.

VIENNA DE SUPERFÍCIE

230 V LED 9 W 3000 K 1300 lm Ra 80

R12589 branco

€ 88 %

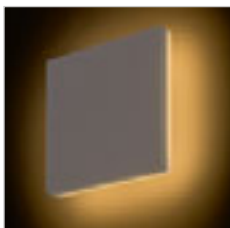
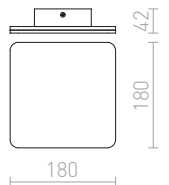

IP54

ATHI

Luminária de parede quadrada com LED integrado para iluminação indireta refletindo a luz da parede. Adequada para uso interior e exterior.

ATHI NA PAREDE

230 V LED 9,6 W 3000 K 550 lm Ra 80 IP54

R12551 branco

€ 120

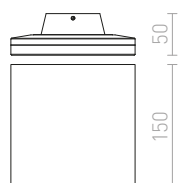



IP65



IP65

TITO

Luminária de parede LED para iluminação direcional com possibilidade de configurar o feixe de luz. Regulação da intensidade da luz TRIAC.

TITO R DIMM NA PAREDE

230 V LED 2x3 W 3000 K 500 lm Ra 80 IP65

R13736 branco

€ 88

NEW

R13737 preto

€ 88

NEW

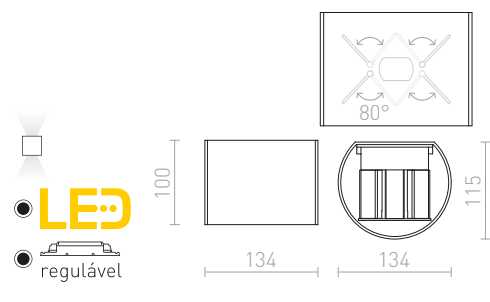

TITO SQ DIMM NA PAREDE

230 V LED 2x3 W 3000 K 500 lm Ra 80 IP65

R13738 branco

€ 78

NEW

R13739 preto

€ 78

NEW

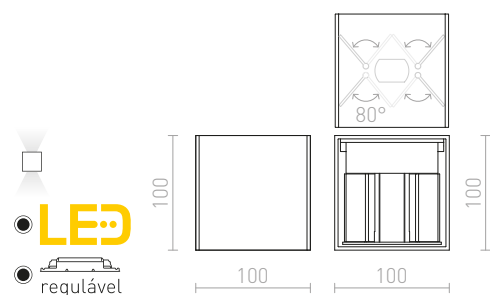



IP54

CARRE

Luminária de parede angular com LED integrado para iluminação bidirecional, com possibilidade de configurar feixe de luz.

CARRE NA PAREDE

230 V LED 2x3 W 3000 K 200 lm Ra 80 IP54

R12556 branco

€ 98

R12557 cinzento antracite

€ 98

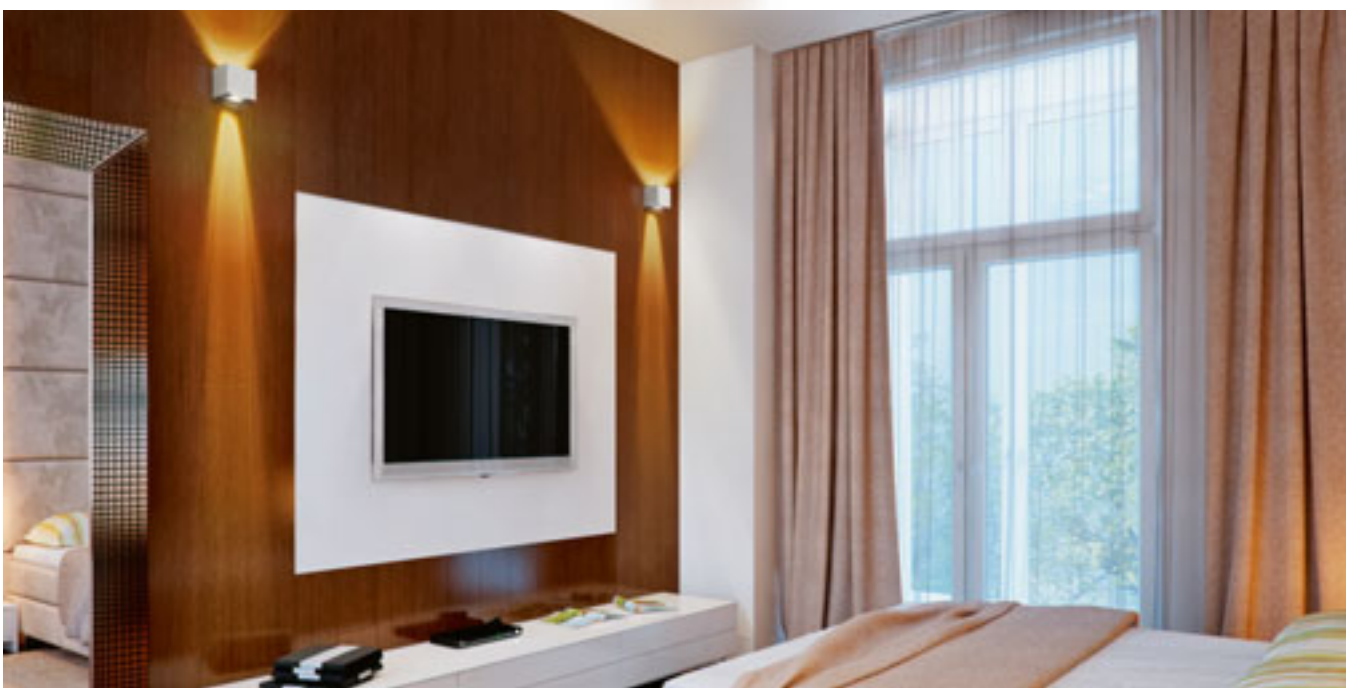
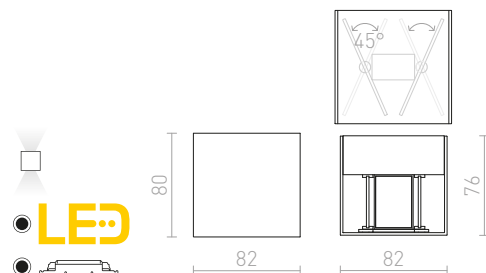

IP54

TITO

Luminária de parede LED para iluminação bidirecional com possibilidade de configurar o feixe de luz.

TITO SQ NA PAREDE

230 V LED 6 W 3000 K 500 lm Ra 80 IP54

R12601 alumínio escovado

€ 78

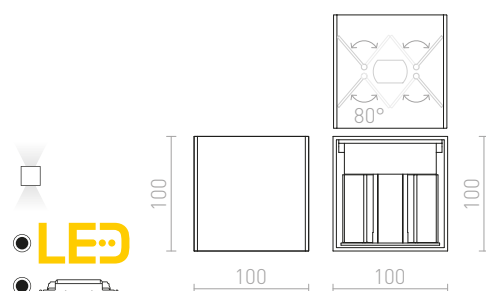

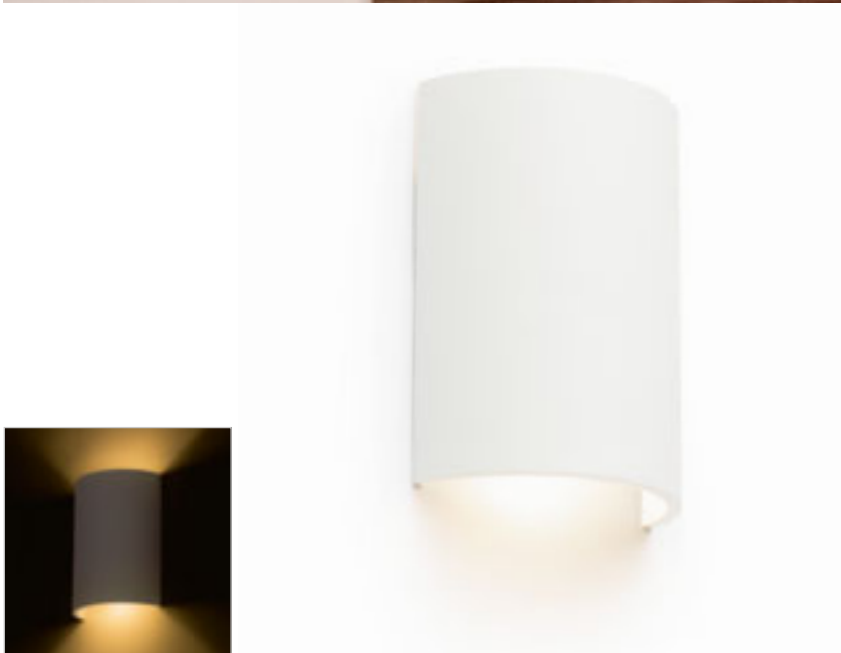

DAFFY

Luminária arredondada com LED integrado para iluminação bidirecional.

DAFFY NA PAREDE

230 V LED 6 W 3000 K 780 lm Ra 80

R12592 branco

€ 120

R12593 preto

€ 120



LED



14,6



50

110



IP54

MIDZACK

Aplique arredondado com LED integrado para iluminação bidirecional.

MIDZACK NA PAREDE

230 V LED 2x3 W 3000 K 480 lm Ra 80 IP54

R12585 branco

€ 88

R12586 preto

€ 88

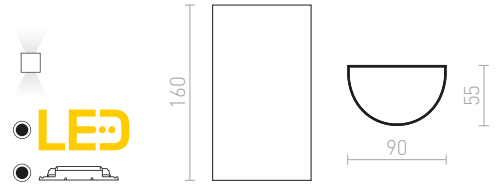

BIARITZ

Luminária circular LED de parede para iluminação bidirecional.

BIARITZ NA PAREDE

230 V LED 5 W 3000 K 780 lm Ra 80

R12606 branco

€ 68

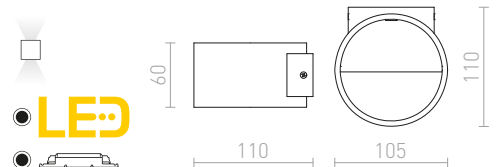

TUBA

Luminária de parede metálica cilíndrica com iluminação bidirecional e casquilho G9.

TUBA W NA PAREDE

230 V G9 33 W

R12739 mate branco

€ 48

R12740 mate preto/ouro

€ 48

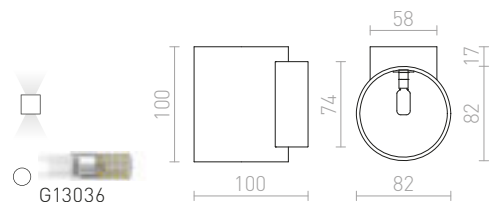



IP54

MICO

Aplique de alumínio fundido com foco fixo para iluminação unidirecional.

MICO I

230 V GU10 35 W IP54

R10170 alumínio

€ 58

%



G11837

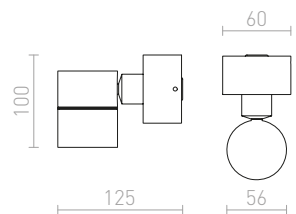



MICO

Aplique pequeno com iluminação bidirecional feito de alumínio polido para fontes de luz de halógeno.

MICO II NA PAREDE

230 V G9 2x25 W

R10129 alumínio

€ 68 %

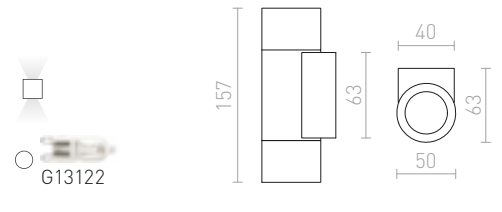

IP54

MOIRE

Aplique de alumínio natural com coberturas de vidro.

MOIRE I

230 V GU10 35 W IP54

R10133 alumínio

€ 58 %

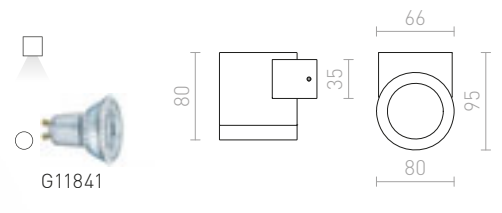

IP54

MOIRE II EXTERIOR

230 V G9 25 W IP54

R10132 alumínio

€ 68 %

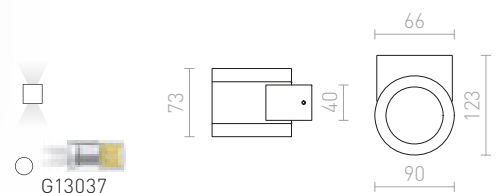

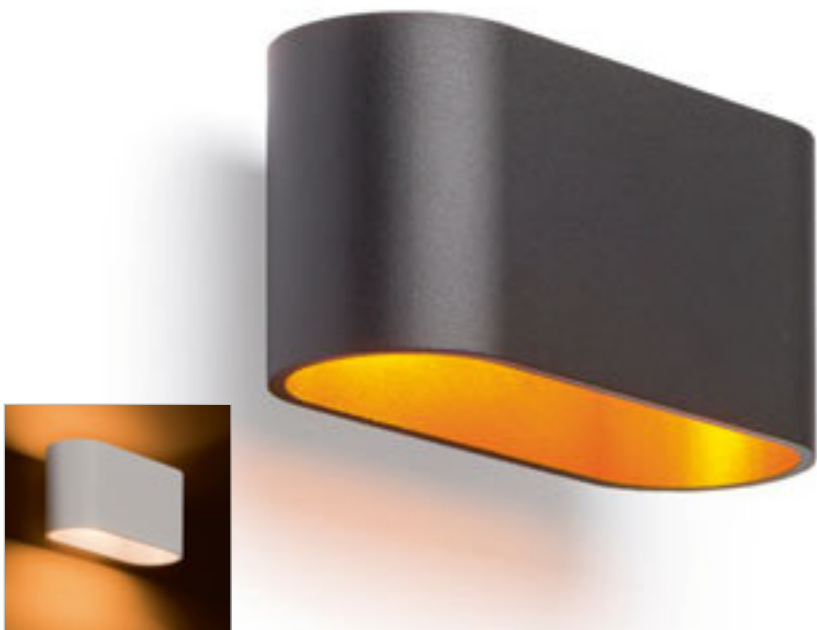

MARIO

Luminária metálica oval com iluminação bidirecional e casquilho G9.

MARIO

230 V G9 33 W

R12743 mate branco

€ 58

R12744 mate preto/ouro

€ 68

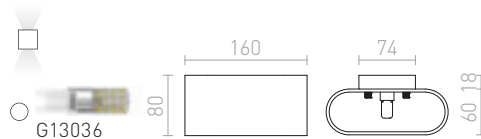

ROZA

Aplique bidirecional de cantos arredondados com LED integrado.

ROZA NA PAREDE

230 V LED 6 W 3000 K 315 lm Ra 80

R12575 branco

€ 58

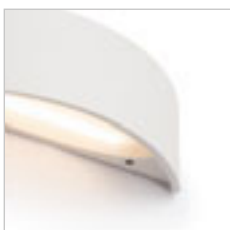
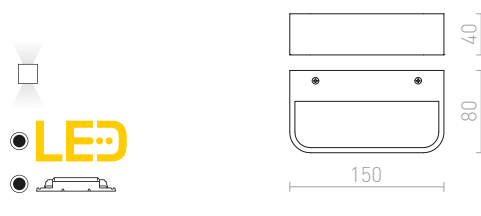

NAXOS

Aplique com forma de arco e LED integrado para iluminação bidirecional.

NAXOS NA PAREDE

230 V LED 6 W 3000 K 780 lm Ra 80

R12590 branco

€ 120 %

R12591 metal escovado

€ 120 %

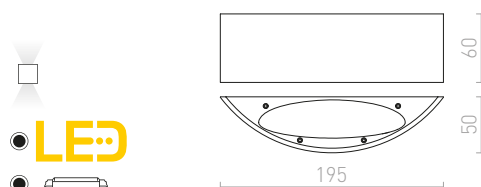



TAPA

Luminária de parede retangular para exterior em metal lacado, bidirecional LED.

TAPA NA PAREDE

230 V LED 6 W 3000 K 277 lm Ra 80 [IP54](#)

R13562 branco

€ 78

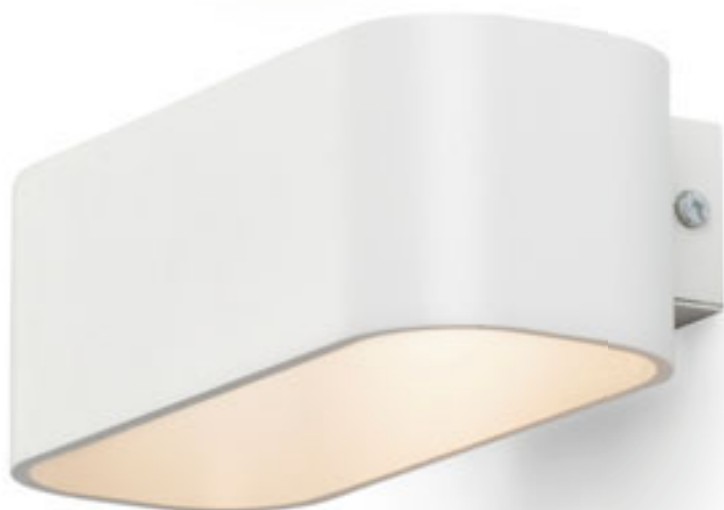
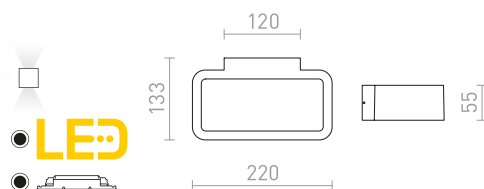

REEM

Aplique com LED integrado de alumínio lacado para iluminação bidirecional.

REEM NA PAREDE

230 V LED 4,5 W 3000 K 300 lm Ra 80

R10401 branco

€ 120

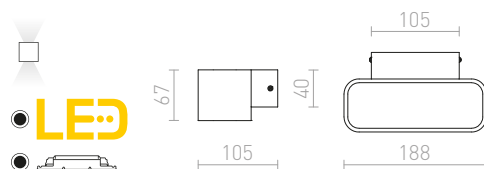



TRIP

Luminária de parede retangular de metal com iluminação bidirecional e casquilho G9.

TRIP SQ NA PAREDE

230 V G9 33 W

R12741 mate branco

€ 38

R12742 mate preto/ouro

€ 48

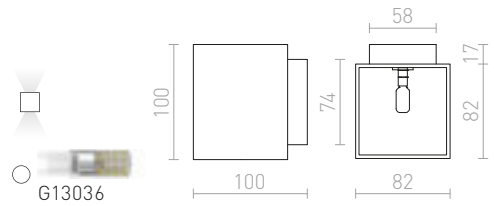

DIDO

Luminária retangular de alumínio lacado a branco com LED de alta potência para iluminação bidirecional.

DIDO NA PAREDE

230 V/500 mA LED 4,5 W 3000 K 250 lm Ra 80

R10400 branco

€ 98

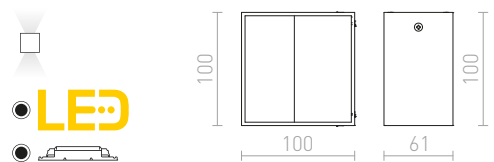

ESSEX

Luminária metálica quadrada de parede para fonte de luz com casquilho G9 e iluminação bidirecional.

ESSEX NA PAREDE

230 V G9 33 W

R12679 mate branco

€ 35

R12680 alumínio escovado

€ 38

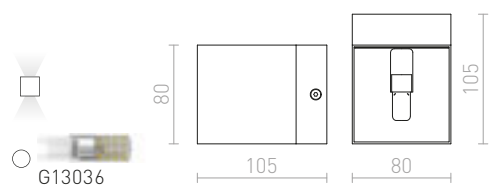



ONYX

Luminária de parede cúbica com LED integrado, cantos arredondados e uma superfície de reflexão estruturada para iluminação bidirecional.

ONYX NA PAREDE

230 V LED 5 W 3000 K 500 lm Ra 80

R12598 branco

€ 68

R12599 preto

€ 68

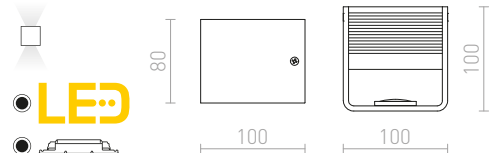

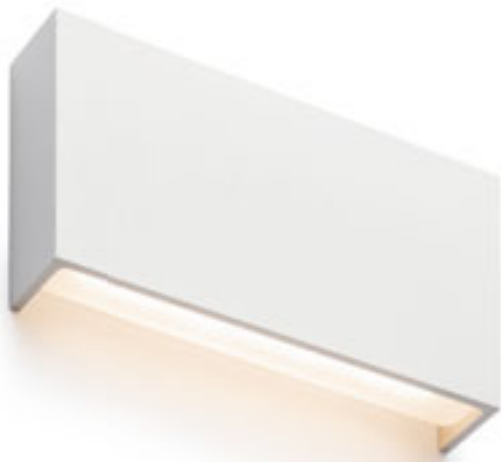

IP54

TORINO

Luminária LED retangular de parede com iluminação bidirecional.

TORINO NA PAREDE

230 V LED 2x5 W 3000 K 550 lm Ra 80 IP54

R12573 branco

€ 150

R12574 preto

€ 150



LED

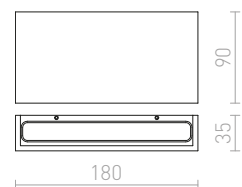
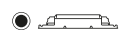



LEA

Luminária de parede LED retangular para iluminação bidirecional.

LEA NA PAREDE

230 V LED 6 W 3000 K 650 lm Ra 80

R12587 branco

€ 88

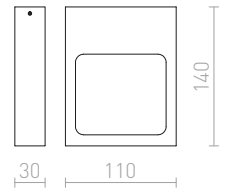
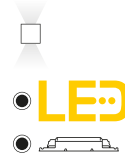

NEMAN

Luminária de parede angular com LED integrado para iluminação bidirecional.

NEMAN NA PAREDE

230 V LED 10 W 3000 K 1300 lm Ra 80

R12595 preto

€ 120

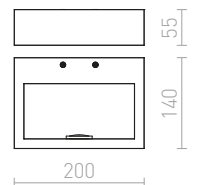
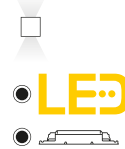

CHLOE

Aplique retangular em aço inoxidável, para iluminação indireta de uso interior ou exterior.

CHLOE NA PAREDE

230 V LED 9 W 3000 K 800 lm Ra 80 IP65

R11752 aço inoxidável

€ 120

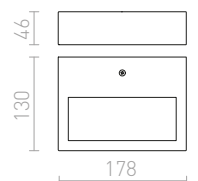
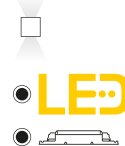

IP65



PEKKO

Aplique retangular para exteriores com LED integrado para iluminação unidirecional.

PEKKO NA PAREDE

230 V LED 3 W $\angle 67^\circ$ 3000 K 86 lm Ra 80 [IP54](#)

R12552 branco

€ 88

R12553 preto

€ 88

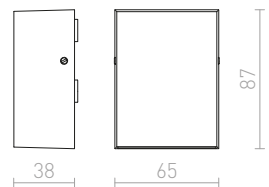
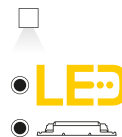

IP54



NOZ

Luminária de alumínio de parede para iluminação unidirecional. Inclui um driver incorporado.

NOZ LED NA PAREDE

230 V/700 mA LED 3 W 3000 K 201 lm Ra 80

R10197 alumínio escovado

€ 24

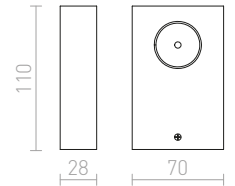
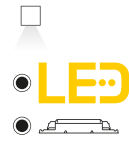

IP54



KORSO

Aplique com LED integrado para interiores e exteriores. Feito de alumínio com acabamento anodizado natural ou preto escovado.

KORSO I NA PAREDE

230 V LED 5 W $\angle 120^\circ$ 3000 K 390 lm Ra 80 IP54

R12829 alumínio escovado

€ 68

R12830 anodizado negro

€ 78

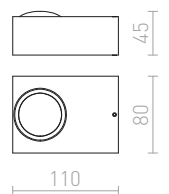
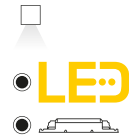

IP54

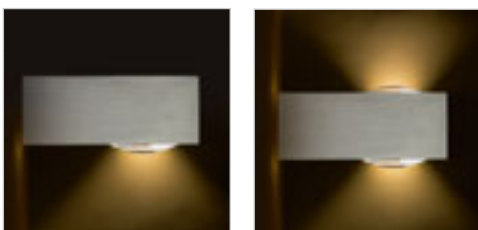

KORSO II NA PAREDE

230 V LED 2x3 W $\angle 120^\circ$ 3000 K 780 lm Ra 80 IP54

R12831 alumínio escovado

€ 78

R12832 anodizado negro

€ 98

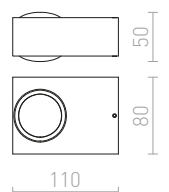
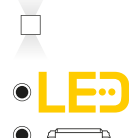

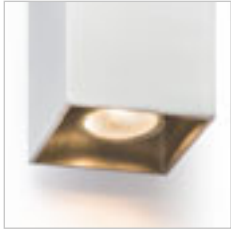

AGATE

Luminária quadrada metálica de parede com iluminação bidirecional para duas fontes de luz refletoras GU10.

AGATE II NA PAREDE

230 V GU10 2x35 W

R12677 mate branco

€ 68

R12678 alumínio escovado

€ 58

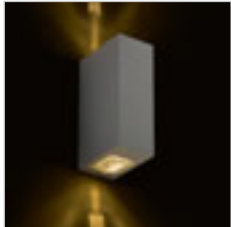
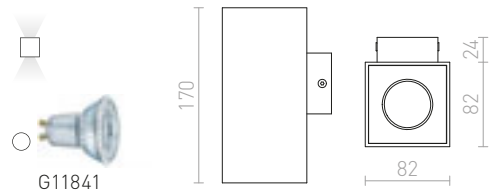

IP54

NICK

Aplique com LED integrado e iluminação bidirecional adequado para interiores e exteriores.

NICK II NA PAREDE

230 V LED 2x3 W $\angle 10^\circ$ 3000 K 780 lm Ra 80 IP54

R12827 alumínio escovado

€ 68

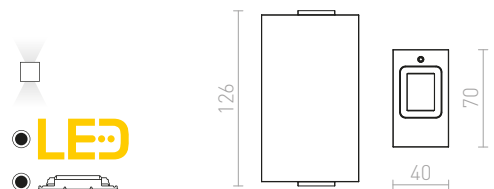

IP54

UKKO

Aplique retangular para exteriores com LED integrado, para iluminação bidirecional.

UKKO NA PAREDE

230 V LED 2x3 W $\angle 55^\circ$ 3000 K 180 lm Ra 80 IP54

R12555 preto

€ 120

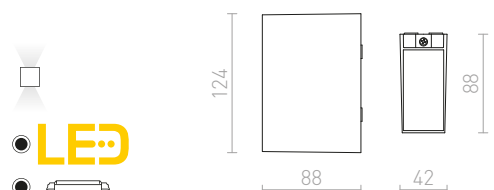



IP44

DESMOND

Candeeiro de parede em alumínio para exterior com iluminação bidirecional para duas fontes de luz LED com casquilho GU10.

DESMOND II NA PAREDE

230 V GU10 2x35 W IP44

R13609 branco

€ 68

R13610 cinzento prata

€ 68

R13611 cinzento antracite

€ 68

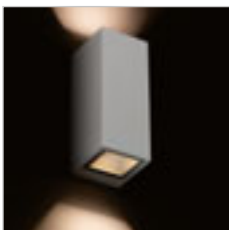

G11841

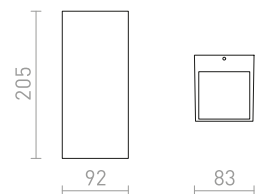

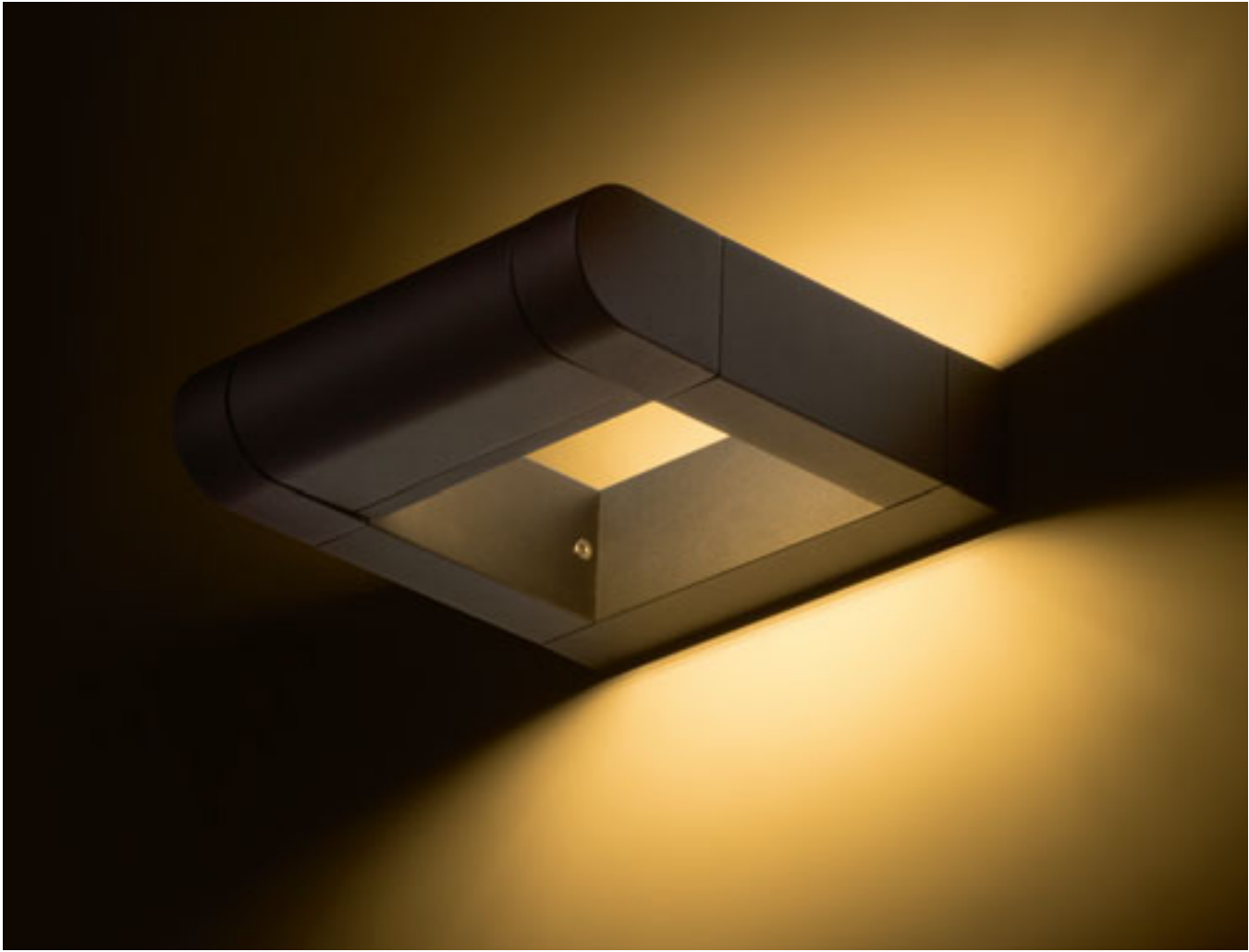

IP54

AQUE

Luminária LED de parede exterior, com a possibilidade de ajustar o foco no eixo.

AQUE NA PAREDE

230 V LED 8 W 3000 K 800 lm Ra 80 IP54

R12623 mate preto

€ 150

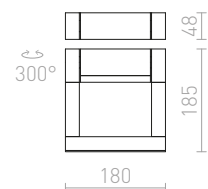



TWIST

Iluminação LED de parede em alumínio para exterior com a opção de definir a iluminação descendente ou como iluminação indireta ascendente.

TWIST NA PAREDE

230 V LED 12 W 3000 K 980 lm Ra 80 IP65

R13615 branco

€ 120

R13616 cinzento antracite

€ 120

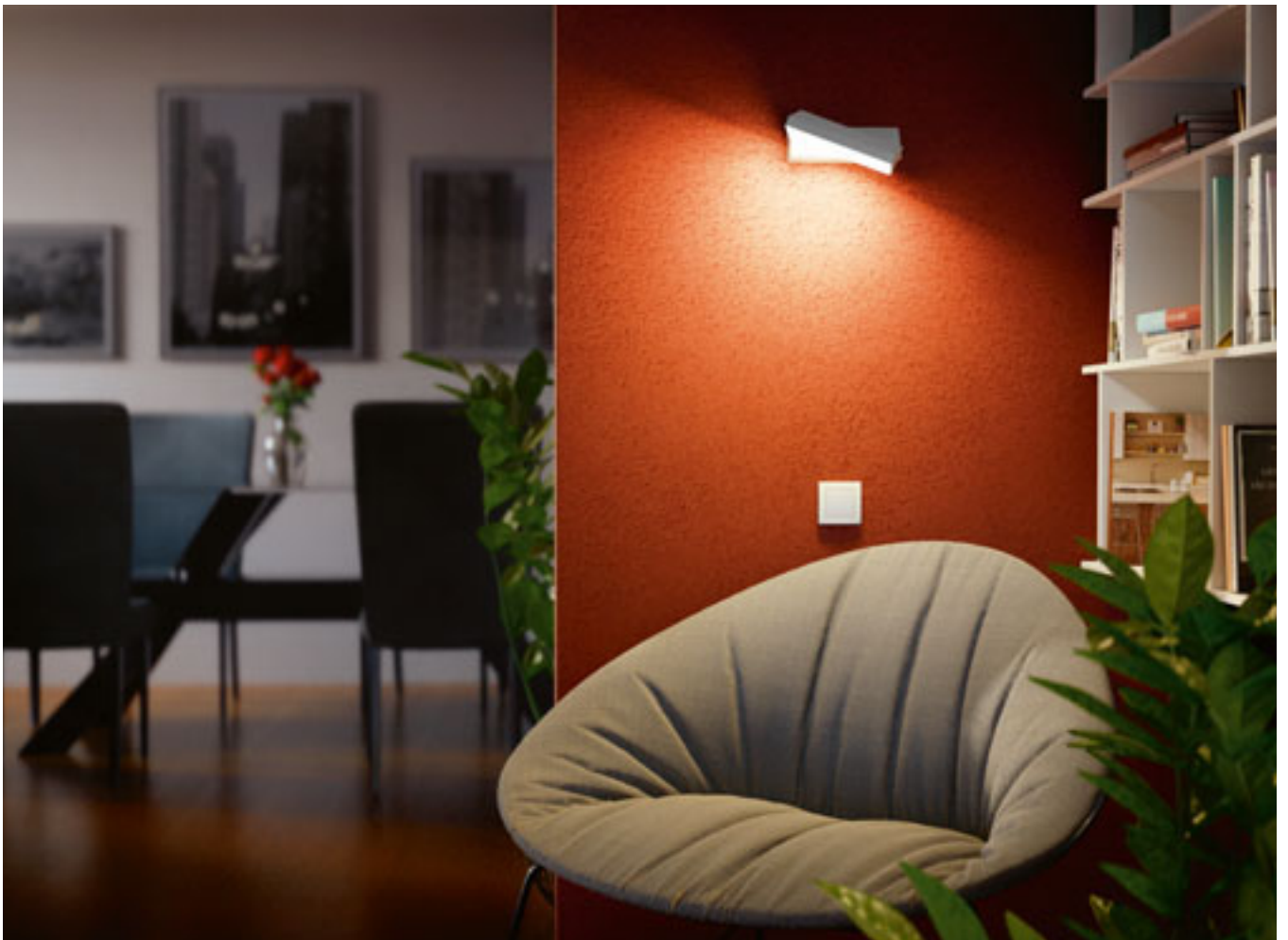
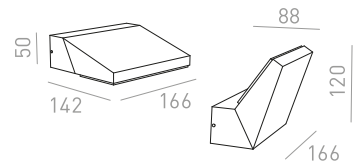
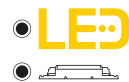

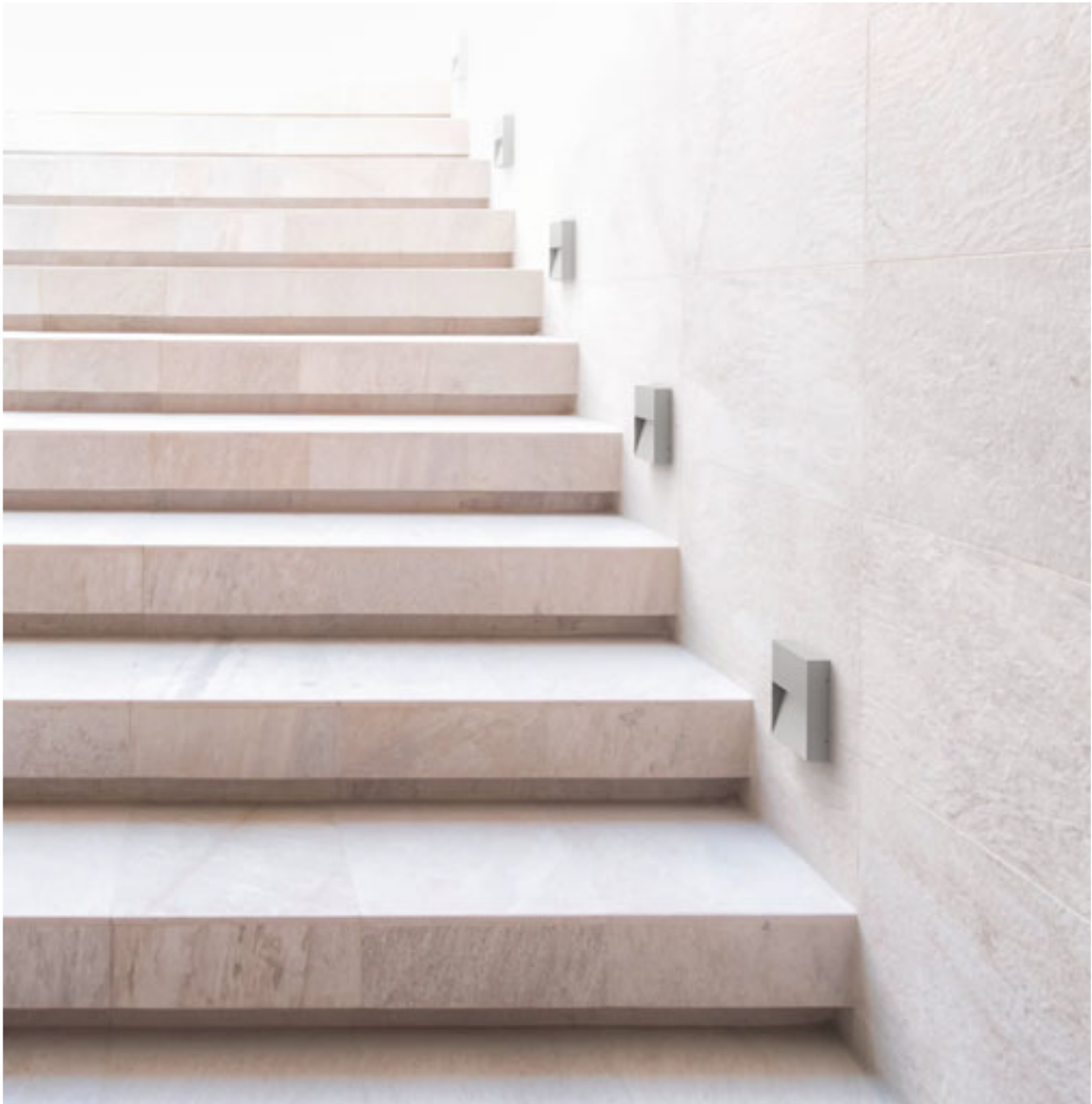

TICO

Luminária em alumínio maciço de feixe único para montagem à superfície.

TICO I NA PAREDE

230 V LED 3 W 3000 K 190 lm Ra 80

R10178 alumínio

€ 48 %

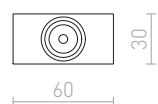
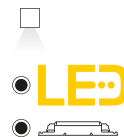



IP54

AMBER

Aplique LED circular de parede para iluminação de orientação. Dispensa rebaixo de parede para a sua aplicação.

AMBER NA PAREDE

230 V LED 3 W 3000 K 130 lm Ra 80

R12610 cinzento

€ 68

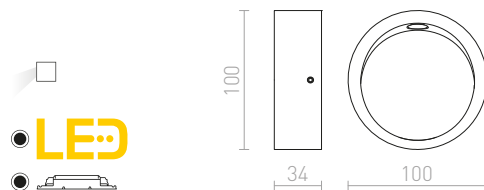

IP54

AQILA

Aplique com LED integrado para iluminação de orientação de pavimentos, escadas ou terraços. Adequado para exterior e interior sem a necessidade de ser embutido.

AQILA SQ NA PAREDE

230 V LED 6 W 3000 K 200 lm Ra 80 IP54

R12542 branco

€ 88

R12543 cinzento

€ 88

R12544 cinzento antracite

€ 88

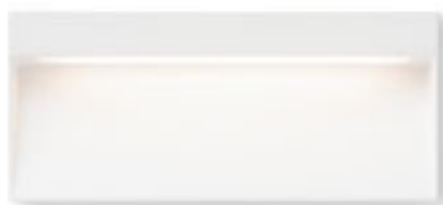
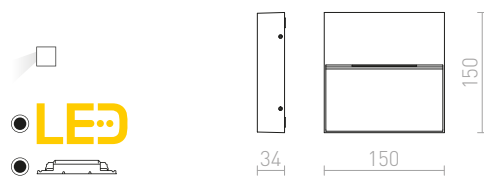
**AQILA RC NA PAREDE**

230 V LED 6 W 3000 K 200 lm Ra 80 IP54

R12545 branco

€ 88 %

R12547 cinzento antracite

€ 120

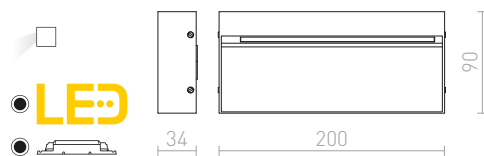

IP54

AQILA R NA PAREDE

230 V LED 6 W 3000 K 200 lm Ra 80 IP54

R12539 branco

€ 88

R12540 cinzento

€ 78 %

R12541 cinzento antracite

€ 88

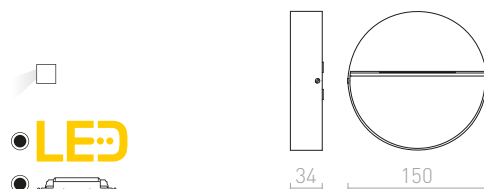

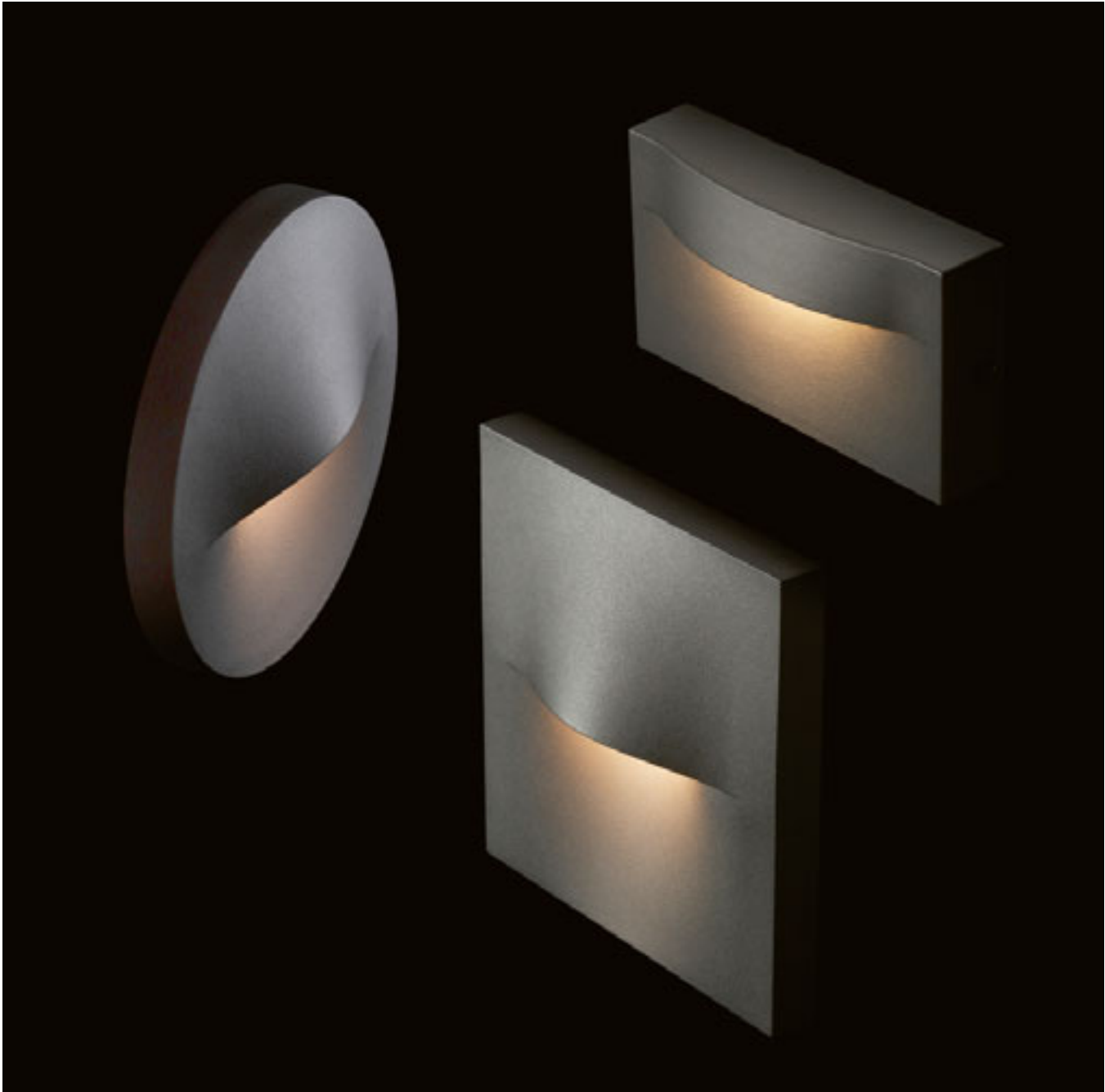

IP65



BOBO

Lâmpada LED de alumínio saliente para uso exterior, adequada para iluminação de caminhos e escadas, sem necessidade de embutir.

BOBO R NA PAREDE

230 V LED 3 W 3000 K 212 lm Ra 80 IP65

R13933 cinzento antracite

€ 58

NEW

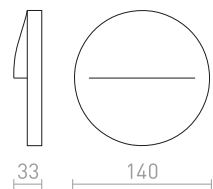
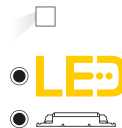



IP65

BOBO

Lâmpada LED de alumínio saliente para uso exterior; adequada para iluminação de caminhos e escadas, sem necessidade de embutir.

BOBO RC NA PAREDE

230V LED 8W 3000K 640lm Ra80 IP65

R13934 cinzento antracite

€ 58

NEW



LED

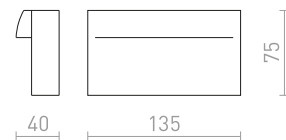

IP65

BOBO

Lâmpada LED de alumínio saliente para uso exterior; adequada para iluminação de caminhos e escadas, sem necessidade de embutir.

BOBO SQ NA PAREDE

230V LED 3W 3000K 135lm Ra80 IP65

R13935 cinzento antracite

€ 58

NEW



LED

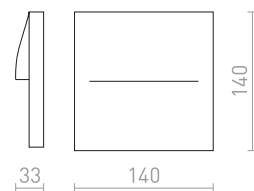



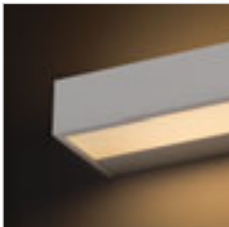

PRIO LED

Luminária de parede em alumínio com LED integrado, para iluminação bidirecional. Disponível em duas cores. O aplique não pode ser usado como prateleira!

PRIO LED 38 NA PAREDE

230 V LED 16 W 3000 K 489 lm Ra 80

R12090 alumínio escovado € 120 %

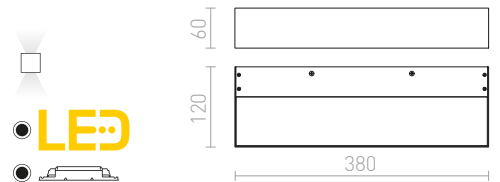

PRIO LED 62 NA PAREDE

230 V LED 33 W 3000 K 720 lm Ra 80

R12091 branco € 188 %

R12092 alumínio escovado € 198 %

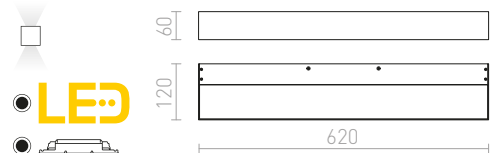

RIVIER

Luminária montada na superfície para fontes de luz fluorescentes T5, com cobertura de vidro transparente e base cromada.

RIVIER TETO

230 V G5 2x21 W

R10239 vidro transparente/cromo € 215 ➔

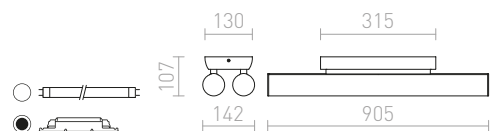



SWING

Luminária LED linear adequada para iluminar quadros.

SWING TOPO DE QUADRO

230 V LED 8 W 3000 K 750 lm Ra 80

R12952 alumínio escovado

€ 129 %

R12954 cromo

€ 138 %

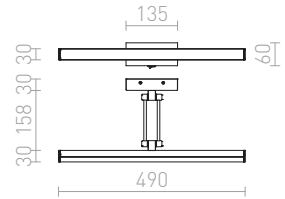
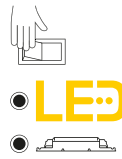

IP44

SWAY

Luminária LED linear inclinável, ideal acima de espelhos ou quadros.

SWAY CASA DE BANHO

230 V LED 12 W 3000 K 1060 lm Ra 80 IP44

R12951 cromo

€ 120

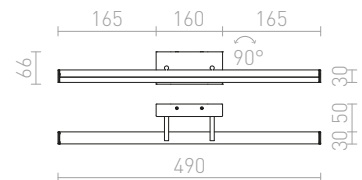

IP44

PANON

Luminária LED linear sobre braço fixo com LED integrado para iluminação descendente. Adequada para ambientes húmidos.

PANON LONG NA PAREDE

230 V LED 12 W 3000 K 900 lm Ra 80 IP44

R12950 cromo

€ 129

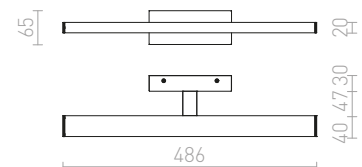
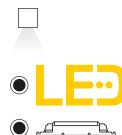



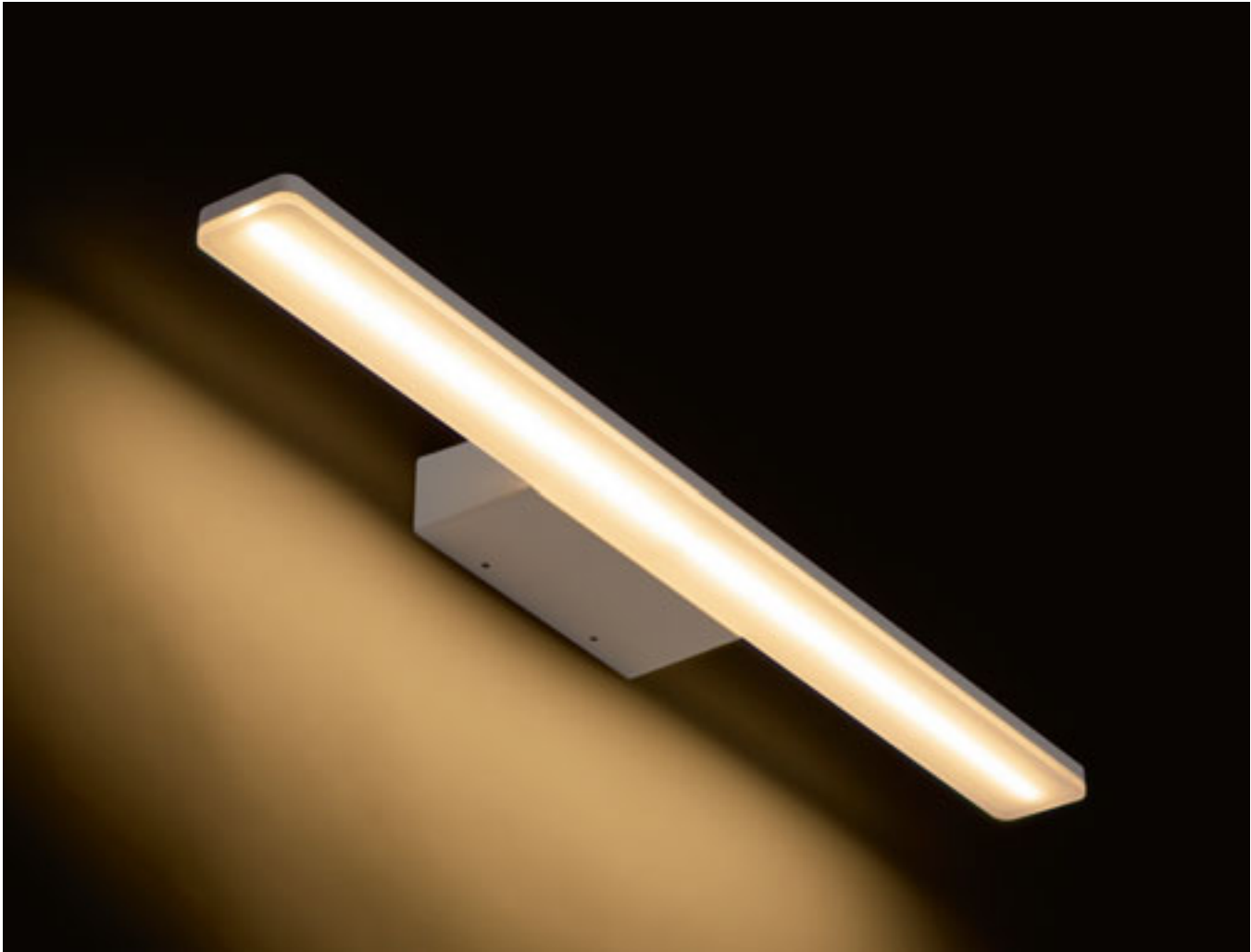

IP44



MAREA

Luminária linear LED com iluminação descendente, adequada para colocar acima do espelho. Para uso em ambientes húmidos.

MAREA 60 NA PAREDE

230 V LED 18 W 3000 K 1954 lm Ra 80 IP44

R13554 branco

€ 198

R13852 preto

€ 198

NEW

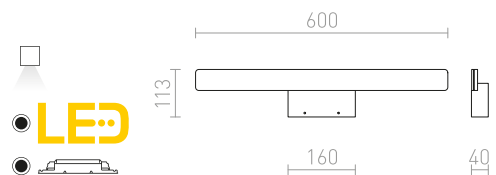



IP44



IMPERISO

Luminária linear LED adequada para colocar acima de espelho. A frente pode girar no eixo horizontal. Para uso em ambientes húmidos.

IMPERISO 60

230 V LED 18 W 3000 K 1769 lm Ra 80 IP44

R13555 branco

€ 248

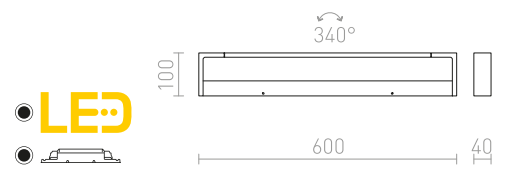

IP54

LUISA

Luminária linear LED com iluminação descendente, adequada para colocar acima do espelho. Para uso em ambientes húmidos.

LUISA 60 NA PAREDE

230 V LED 12 W 3000 K 1138 lm Ra 80 IP54

R13735 branco

€ 150

R13853 preto

€ 138

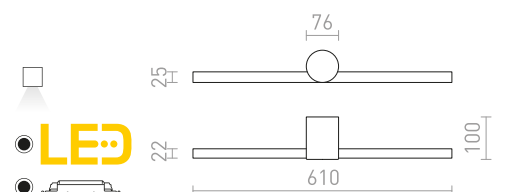

NEW

NEW



IP44



IP44



FLORIO

Luminária LED indicada para casa de banho, com ficha integrada para aparelhos de baixo consumo até 100W.

FLORIO 49 PAREDE

230 V LED 8W 3000 K 640 lm Ra 80 IP44

R12903 branco

€ 88

R12904 cromo

€ 98



LED

55



480

65



IP44



IP44



CORAZON

Luminária linear com LED integrado, adequada para ambientes húmidos.

CORAZON 60

230 V LED 15W 3000 K 1200 lm Ra 80 IP44

R12901 cromo

€ 78



LED

51



600

70



CORAZON 90

230 V LED 20W 3000 K 1600 lm Ra 80 IP44

R12902 cromo

€ 120



LED

51



900

70







FOCOS

CASA DE BANHO	290-293
CONJUNTOS	294-311
PARA CAMA	312-319
EM BRAÇO ARTICULADO	320-325
INCLINÁVEIS	326-335

FOCOS CASA DE BANHO



LINN I
290-291



LINN III
290-291



BOLLY III
290-291

290-293



VALTO I
290-291



VALTO III
290-291



DUBLIN I
292-293



DUBLIN II
292-293



DUBLIN III
292-293



DUBLIN IV
292-293

FOCOS CONJUNTOS



ELISEO
294-295



ELISEO II
294-295



BOGARD I
296-297

294-311



BOGARD II
296-297



BOGARD III
296-297



KENNY I
298-299



KENNY II
298-299

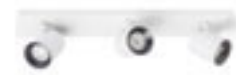

KENNY III
298-299



KENNY IV
298-299



DUDE R
300-301



DUDE SQ
300-301



DUDE
300-301



DUDE II
300-301



DIGA I
302-303



DUGME I
302-303



DUGME II
302-303



DUGME III
302-303



TRICA I
304-305



TRICA II
304-305



TRICA III
304-305



GLOSSY
306-307



GLOSSY I
306-307



GLOSSY III
306-307



ROSITA I
306-307



ROSITA II
306-307



KELLY LED I
308-309



KELLY LED II
308-309



KELLY LED III
308-309



KELLY LED
308-309



KELLY LED I
310-311



KELLY LED II
310-311



KELLY LED III
310-311

FOCOS PARA CAMA

312-319



VERSINA
312-313



VERSINA
312-313



TAINA
312-313



PERTH
312-313



ARAQ
314-315



HAREN
314-315



ROSTAM
314-315



CHOUPEPTE
314-315



SIENA
316-317



VOLTERA USB
316-317



AMADEUS I
316-317



THALIA
316-317



VIPER WL
318-319



TIARA
318-319



FADO I
318-319



MIG
318-319



TAPIO ISQ
318-319

FOCOS EM BRAÇO ARTICULADO

320-325



AIM
320-321



FRISCO W
320-321



EKE
320-321



VALE
320-321



POINT
322-323



VERSA
322-323



SHOW
322-323



BOB
322-323



FRISCO D
324-325



KAYA
324-325



FLAP
324-325

FOCOS INCLINÁVEIS

326-335



BELENOS
326-327



BOGARD
326-327



BOGARD TWIN
326-327



OPTIMUS
326-327



DARIO
328-329



PIXIE
328-329



CELEIA
330-331



AGNETA
330-331



BAROQUE
330-331



JOLI I
330-331



CASSIE
332-333



BUGSY I
332-333



ORIT
332-333



REDO
334-335



MARVEL
334-335



MARVEL II
334-335



IP44

BOLLY

Luminária de parede ou teto com vidro opalino sobre base cromada. Adequado para ambientes húmidos.

BOLLY III DE SUPERFÍCIE

230 V G9 LED 3x3 W IP44

R13691 vidro colorido opala/cromo

€ 138

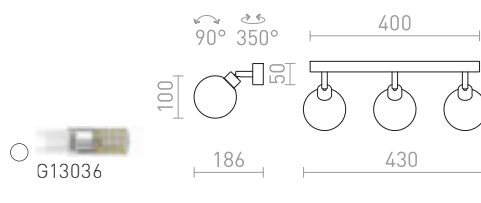

IP44

LINN

Candeeiro de parede ou teto com vidro opalino e base cromada. Adequado para casas de banho.

LINN I NA PAREDE

230 V G9 LED 3 W IP44

R13695 vidro colorido opala/cromo

€ 48

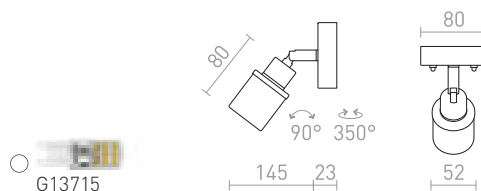

LINN III DE SUPERFÍCIE

230 V G9 LED 3x3 W IP44

R13703 vidro colorido opala/cromo

€ 120

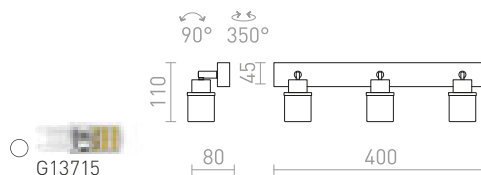



IP44

VALTO

Luminária de parede ou teto com refletores inclináveis para fontes de luz LED com casquilho GU10. Adequado para casas de banho.

VALTO I NA PAREDE

230 V GU10 LED 5 W IP44

R13696 cromo

€ 48

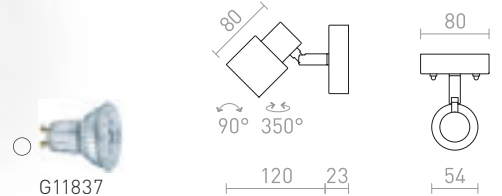

VALTO III DE SUPERFÍCIE

230 V GU10 LED 3x5 W IP44

R13704 cromo

€ 98

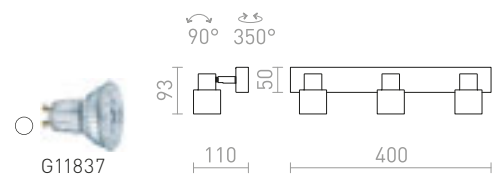





IP44



IP44



IP44



IP44

DUBLIN

Foco cromado adequado para casas de banho.

DUBLIN I DE SUPERFÍCIE

230 V GU10 9 W IP44

R13377 cromo

€ 48

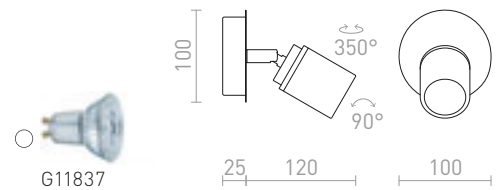

DUBLIN II DE SUPERFÍCIE

230 V GU10 2x9 W IP44

R13378 cromo

€ 88

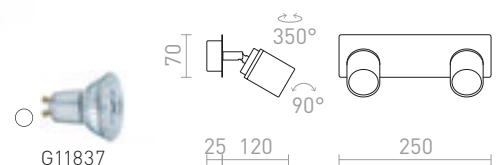

DUBLIN III DE SUPERFÍCIE

230 V GU10 3x9 W IP44

R13379 cromo

€ 120

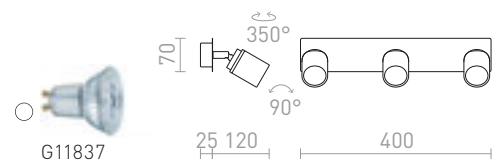

DUBLIN IV DE SUPERFÍCIE

230 V GU10 4x9 W IP44

R13380 cromo

€ 150

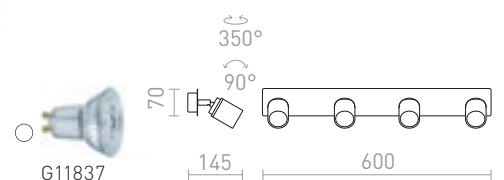





ELISEO

Lâmpada LED montada em superfície com cabeça giratória em forma de pires e difusor de cor opala.

ELISEO II MONTADO À SUPERFÍCIE

230 V LED 2x5 W 3000 K 760 lm Ra 80

R13916 branco

€ 150

NEW

R13917 preto

€ 150

NEW

LED

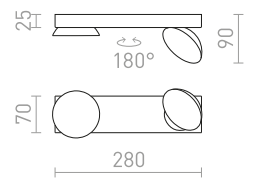

ELISEO

Luminária de parede com cabeça giratória em forma de pires, LED embutido e difusor de cor opala.

ELISEO NA PAREDE

230 V LED 5 W 3000 K 320 lm Ra 80

R13914 branco

€ 88

NEW

R13915 preto

€ 88

NEW

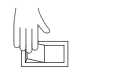

LED

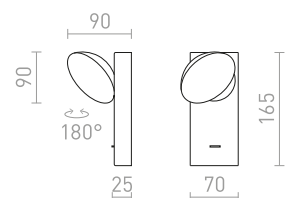



BOGARD

Foco de parede inclinável com LED integrado.

BOGARD I NA PAREDE

230 V LED 5 W $\angle 40^\circ$ 3000 K 350 lm Ra 80

R12501 mate preto

€ 68

R12502 níquel mate

€ 58

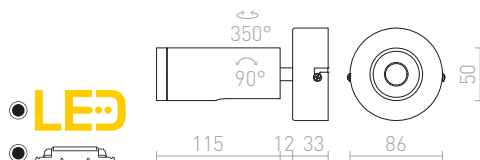

BOGARD II NA PAREDE

230 V LED 2x5 W $\angle 40^\circ$ 3000 K 700 lm Ra 80

R12503 mate preto

€ 98

R12504 níquel mate

€ 88

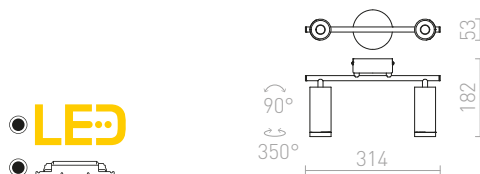

BOGARD III NA PAREDE

230 V LED 3x5 W $\angle 40^\circ$ 3000 K 1050 lm Ra 80

R12505 mate preto

€ 129

R12506 níquel mate

€ 120

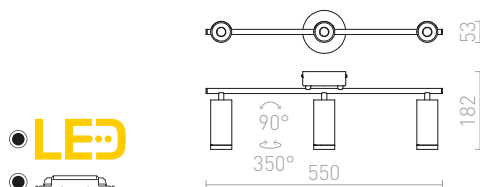





KENNY

Série elegante de focos para fontes de luz GU10.
É possível alterar a aparência com molduras de cores intercambiáveis (opcional).

KENNY I DE SUPERFÍCIE

230 V GU10 35 W

R12912 branco/preto € 58

R12913 alumínio escovado/preto € 58

R12914 preto/ouro € 58

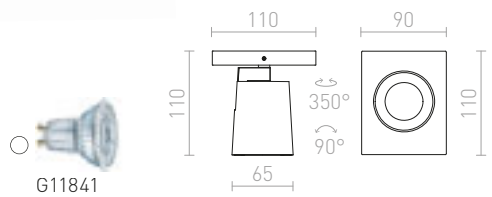

KENNY II DE SUPERFÍCIE

230 V GU10 2x35 W

R12915 branco/preto € 120

R12916 alumínio escovado/preto € 120

R12917 preto/ouro € 120

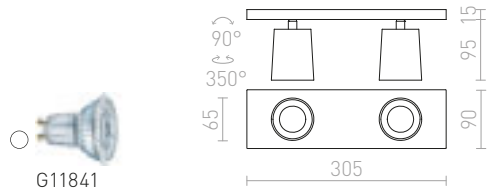

KENNY III DE SUPERFÍCIE

230 V GU10 3x35 W

R12918 branco/preto € 150

R12919 alumínio escovado/preto € 158

R12920 preto/ouro € 150

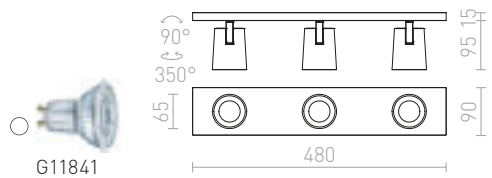

KENNY IV TETO

230 V GU10 4x35 W

R12921 branco/preto € 215

R12922 alumínio escovado/preto € 215

R12923 preto/ouro € 215

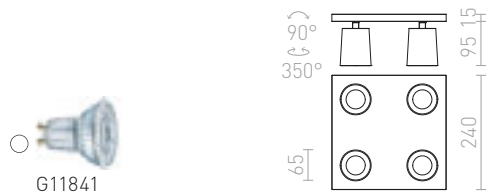



KENNY

Anel de substituição da série Kenny, para facilmente alterar design através da cor.

KENNY ANEL DECORATIVO

R12924 branco	€ 3.50
R12925 ouro	€ 3.50
R12926 preto	€ 3.50

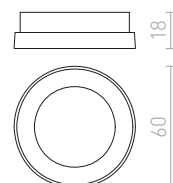



DUDE

Luminária de parede com interruptor para fontes de luz LED com casquilho GU10.

DUDE NA PAREDE

230 V LED GU10 9 W

R13924 branco

€ 68 NEW

R13925 preto

€ 68 NEW

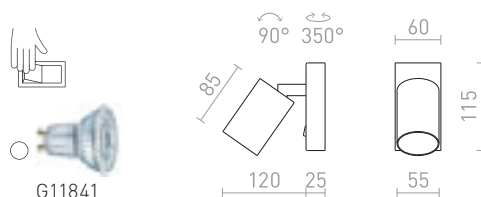

DUDE

Lâmpada saliente para fontes de luz LED com casquilho GU10.

DUDE R MONTADO À SUPERFÍCIE

230 V LED GU10 9 W

R13918 branco

€ 58 NEW

R13919 preto

€ 58 NEW

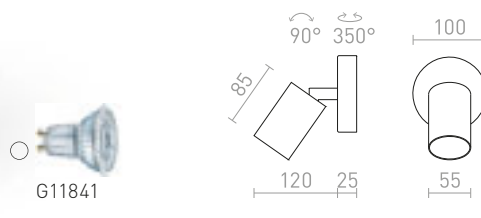

DUDE

Fode superfície para duas fontes de luz LED GU10.

DUDE II MONTADO À SUPERFÍCIE

230 V LED GU10 2x9 W

R13922 branco

€ 120 NEW

R13923 preto

€ 120 NEW

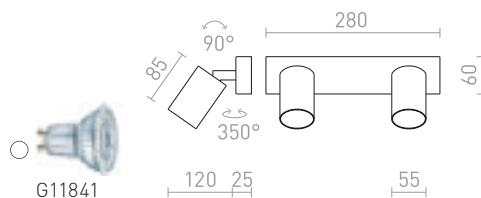



DUDE

Lâmpada saliente para fontes de luz LED com casquilho GU10.

DUDE SQ MONTADO À SUPERFÍCIE

230V LED GU10 9W

R13920 branco

€ 58 NEW

R13921 preto

€ 58 NEW



G11841

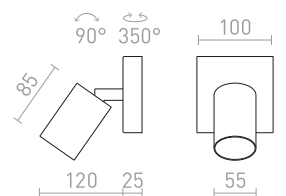





DUGME

Foco de metal lacado em branco com detalhes de antracite.

DUGME I

230 V GU10 35 W

R12076 branco/cinza antracite

€ 58

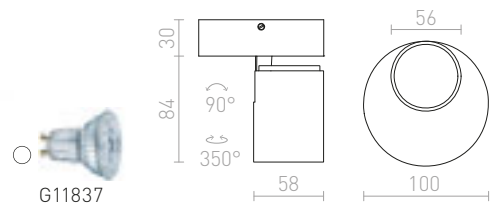

DUGME II

230 V GU10 2x35 W

R12077 branco/cinza antracite

€ 120

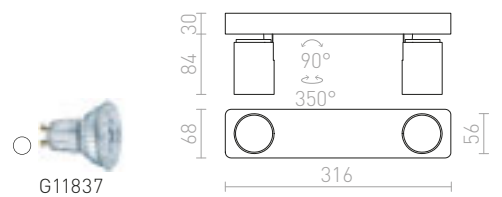

DUGME III

230 V GU10 3x35 W

R12078 branco/cinza antracite

€ 138

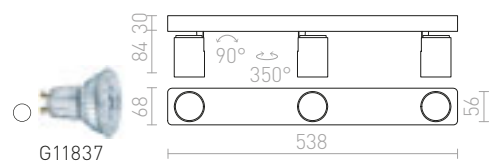

DIGA

Foco LED ajustável em branco com detalhes em antracite.

DIGA I

230 V LED 5 W 3000 K 230 lm Ra 80

R12079 branco/cinza antracite

€ 68

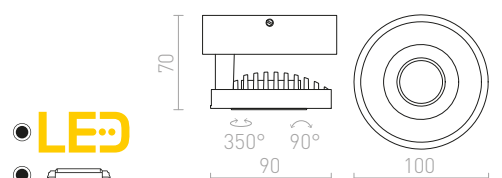



TRICA

Foco de metal minimalista para instalação em parede ou teto, adequado para fontes de luz decorativas GU10.

TRICA I NA PAREDE

230 V GU10 25 W

R13371 branco

€ 22

%

R13372 preto

€ 22

%

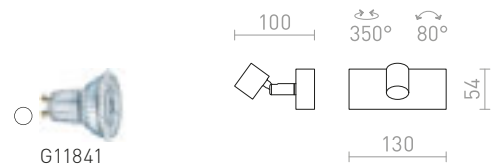

TRICA II NA PAREDE

230 V GU10 2x25 W

R13373 branco

€ 48

%

R13374 preto

€ 48

%

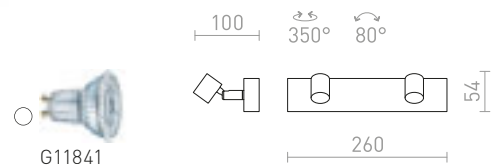

TRICA III NA PAREDE

230 V GU10 3x25 W

R13375 branco

€ 58

%

R13376 preto

€ 58

%

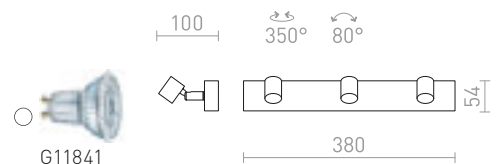





GLOSSY

Luminária saliente com focos inclináveis em dois eixos.

GLOSSY I

230 V LED GU10 8 W

R10542 cromo

€ 48 %

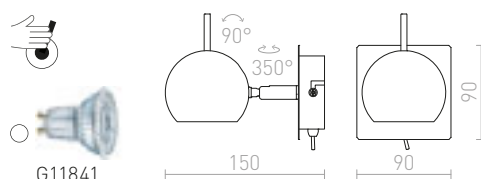

GLOSSY III

230 V LED GU10 3x8 W

R10604 cromo

€ 98 %

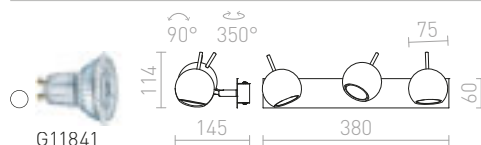

GLOSSY

Luminária de parede com foco em braço articulado. A luminária funciona com um interruptor de alavanca localizado na parte inferior.

GLOSSY EM BRAÇO ARTICULADO

230 V LED GU10 8 W

R10543 cromo

€ 58 %

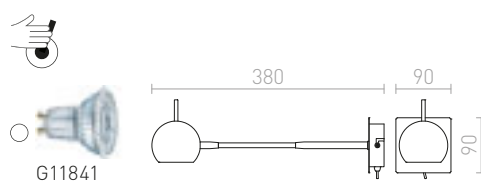



ROSITA

Aplicado de estilo retro para fontes de luz GU10 com baixo consumo energético.

ROSITA I NA PAREDE

230 V LED GU10 9 W

R12507 branco/cinza prateada

€ 58

R12508 preto/ouro

€ 58

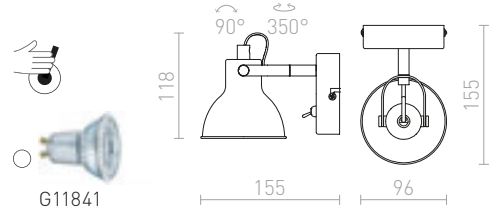

ROSITA II NA PAREDE

230 V LED GU10 2x9 W

R12509 branco/cinza prateada

€ 120 %

R12510 preto/ouro

€ 129 %

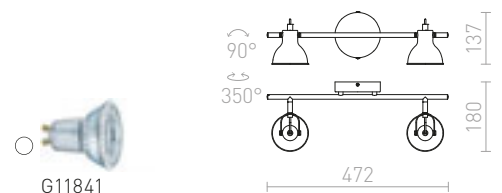



KELLY LED

Luminária de parede ou teto com foco(s) inclinável. Módulos de LED incluídos.

KELLY LED I NA PAREDE

230 V LED 12 W $\angle 24^\circ$ 3000 K 600 lm Ra 80

R12332 branco

€ 120

R12333 preto

€ 120

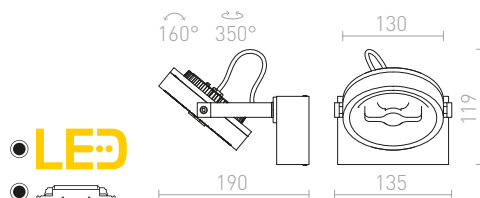

KELLY LED II NA PAREDE

230 V LED 2x12 W $\angle 24^\circ$ 3000 K 1200 lm Ra 80

R12334 branco

€ 229

R12335 preto

€ 229

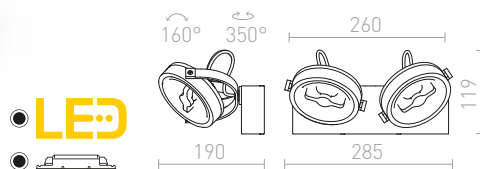

KELLY LED III NA PAREDE

230 V LED 3x12 W $\angle 24^\circ$ 3000 K 1800 lm Ra 80

R12336 branco

€ 329

R12337 preto

€ 329

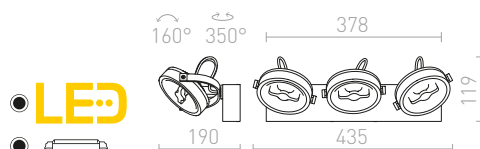



KELLY LED

Luz regulável semi-embutida com LED integrado e um foco direcional. Somente para instalação em teto de gesso cartonado. Regulação da intensidade da luz TRIAC.

KELLY LED DIMM SEMI EMBUTIDA

230 V LED 12 W $\angle 24^\circ$ 3000 K 600 lm Ra 80

R12637 branco

€ 120

R12638 preto

€ 120

↑ 50

● Ø65

● LED

● regulável

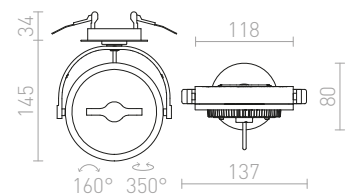





KELLY LED

Luminária de parede/teto com foco(s) e regulação de intensidade da luz TRIAC. Módulos de LED incluídos.

KELLY LED I DIMM NA PAREDE

230 V LED 12 W $\angle 24^\circ$ 3000 K 600 lm Ra 80

R13104 branco

€ 138

R13105 preto

€ 138

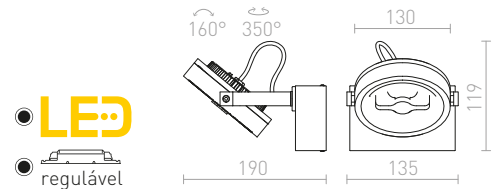

KELLY LED II DIMM NA PAREDE

230 V LED 2x12 W $\angle 24^\circ$ 3000 K 1200 lm Ra 80

R13106 branco

€ 268

R13107 preto

€ 268

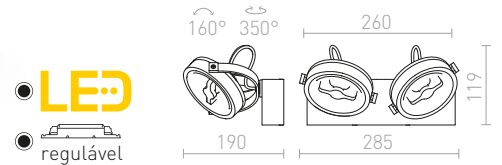

KELLY LED III DIMM NA PAREDE

230 V LED 3x12 W $\angle 24^\circ$ 3000 K 1800 lm Ra 80

R13108 branco

€ 398

R13109 preto

€ 398

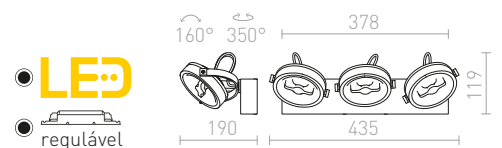

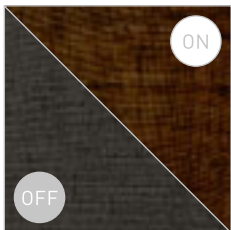
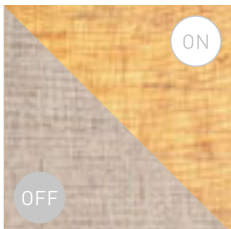

PERTH

Candeeiro de parede com abajur quadrado em tecido complementado por braço flexível com refletor LED. O candeeiro possui duas fontes de luz, que podem ser controladas separadamente por um interruptor rotativo localizado na base quadrada do candeeiro.

PERTH NA PAREDE COM FOCO LED

230 V E14 LED 15 W+3 W $\angle 30^\circ$ 3000 K 150 lm Ra 80

R13661 bege/branco/cromo

€ 178

R13662 preto/preto/cromo

€ 178



G13572

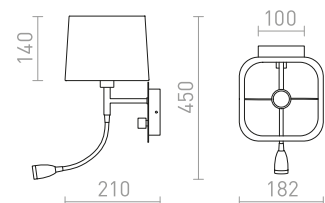



VERSA

Luminária LED de parede com abajur têxtil e foco adicional com braço flexível. As duas fontes de luz podem funcionar separadamente com interruptores localizados na base.

VERSA PAREDE COM ABAJUR

230 V E27 LED 42 W+3 W $\angle 40^\circ$ 3000 K 240 lm Ra 80

R10580 branco/níquel mate

€ 188

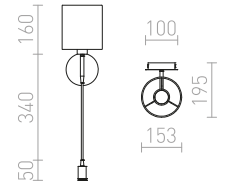
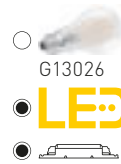

VERSINA

Luminária de parede com abajur têxtil, complementada com foco LED sobre braço flexível. As duas fontes de luz podem funcionar separadamente com interruptores colocados na base.

VERSINA COM ABAJUR

230 V E27 LED 28 W+3 W $\angle 25^\circ$ 3000 K 180 lm Ra 80

R12955 branco/cromo

€ 138

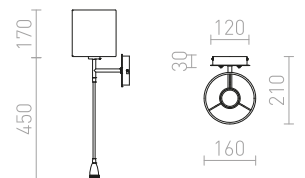

TAINA

Luminária de parede com abajur têxtil com LED sobre braço flexível. As duas fontes de luz podem ser controladas individualmente por interruptores localizados na base da luminária.

TAINA COM ABAJUR

230 V E27 LED 28 W+3 W $\angle 25^\circ$ 3000 K 180 lm Ra 80

R12956 branco/níquel mate

€ 150

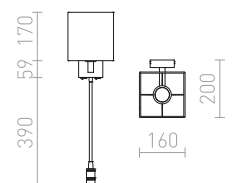

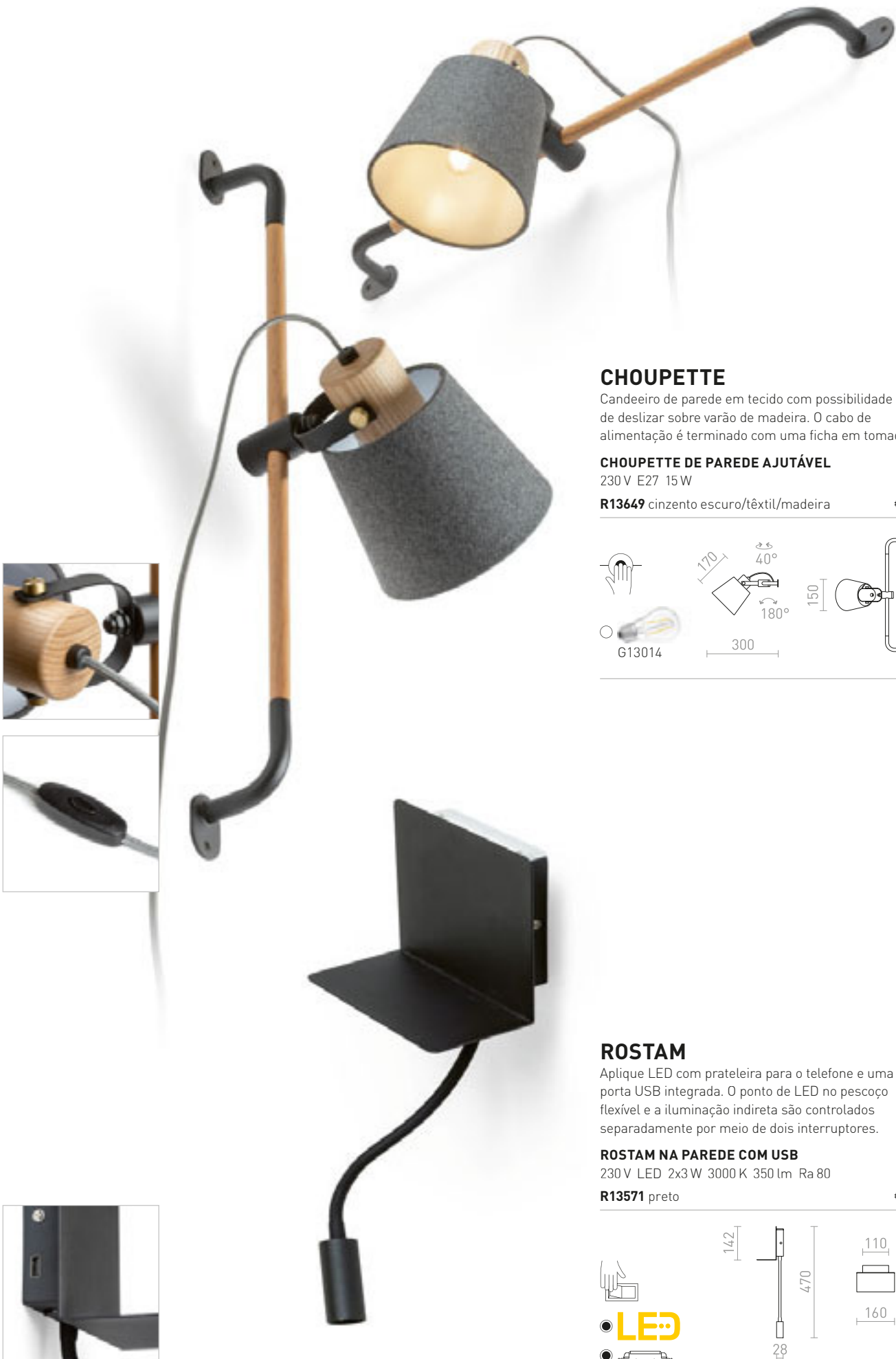

CHOUETTE

Candeeiro de parede em tecido com possibilidade de deslizar sobre varão de madeira. O cabo de alimentação é terminado com uma ficha em tomada.

CHOUETTE DE PAREDE AJUTÁVEL
230 V E27 15 W

R13649 cinzento escuro/têxtil/madeira

€ 229

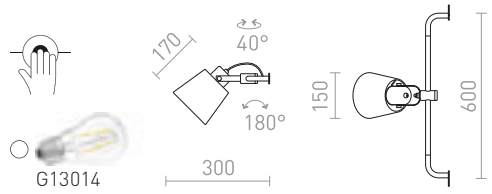

ROSTAM

Aplique LED com prateleira para o telefone e uma porta USB integrada. O ponto de LED no pescoço flexível e a iluminação indireta são controlados separadamente por meio de dois interruptores.

ROSTAM NA PAREDE COM USB

230 V LED 2x3W 3000 K 350 lm Ra 80

R13571 preto

€ 150

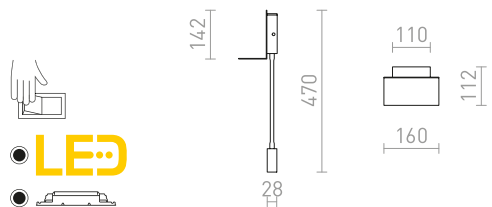



ARAQ

Luminária de parede com casquilho e braço em latão sobre base lacada a preto. Para uso com uma fonte de luz decorativa E27 adequada.

ARAQ NA PAREDE

230 V E27 42 W

R13890 latão escovado/preto

€ 32

NEW

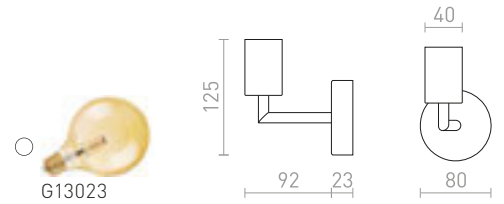

HAREN

Refletor maciço equipado com casquilho E27 para uso com fonte de luz de foco.

HAREN DE SUPERFÍCIE

230 V E27 15 W

R13612 cobre/preto

€ 58

R13613 preto

€ 48

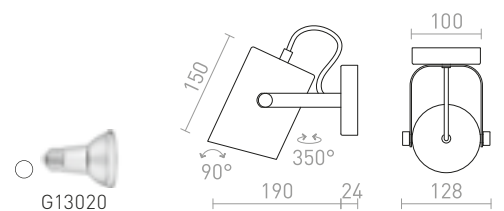



THALIA

Luminária de parede LED com refletor complementada por iluminação indireta. A luminária possui duas fontes de luz que podem ser controladas separadamente por interruptores localizados na base da luminária.

THALIA NA PAREDE

230 V LED 6 W + 3 W 3000 K 480 lm Ra 80

R13765 preto/acrílico acetinado

€ 150

NEW

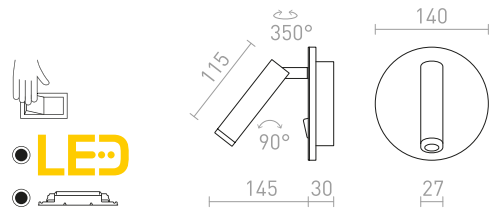

LED

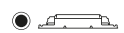

AMADEUS

Aplique LED montado na parede com interruptor na base. O abajur é inclinável.

AMADEUS I NA PAREDE

230 V LED 6 W 3000 K 530 lm Ra 80

R12476 branco

€ 120

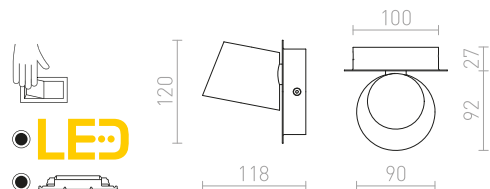

LED





SIENA

Luminária de parede pintada com reflector basculante para fontes luminosas com casquilho GU10. O interruptor está localizado na base.

SIENA NA PAREDE

230 V GU10 50 W

R13761 branco

€ 98

NEW

R13762 preto

€ 98

NEW

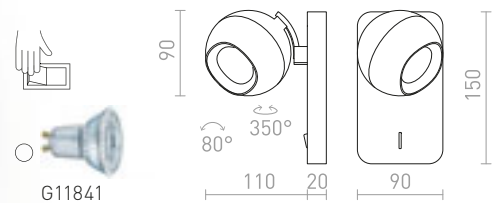

VOLTERA

Luminária de parede pintada com reflector basculante para fontes luminosas com casquilho GU10.

A luminária possui uma porta USB integrada na base adequada para carregar, por exemplo, um telefone.

VOLTERA USB NA PAREDE

230 V GU10 50 W

R13763 branco/preto

€ 120

NEW

R13764 preto

€ 120

NEW

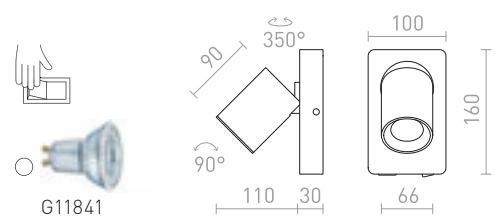



VIPER

Luminária de parede com design elegante, detalhes cromados, um foco LED preto e um cabo têxtil vermelho.

VIPER WL

230 V LED 3 W $\angle 60^\circ$ 3000 K 100 lm Ra 80

R12461 preto/cromo

€ 98

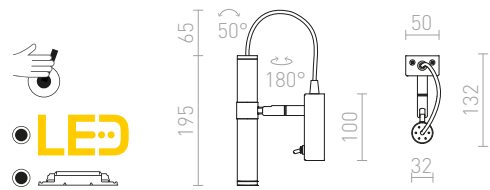

FADO

Luminária de parede retangular com um foco LED ajustável.

FADO I NA PAREDE

230 V LED 3 W $\angle 45^\circ$ 4000 K 110 lm Ra 80

R12473 preto

€ 138

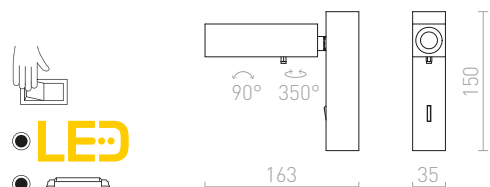

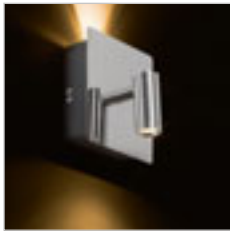

TIARA

Luminária de parede LED com refletor e iluminação indireta superior. Possui duas fontes de luz que podem ser controladas separadamente por interruptores localizados na base da luminária.

TIARA NA PAREDE

230 V LED 2x3 W $\angle 25^\circ$ 3000 K 300 lm Ra 80

R12957 cromo

€ 78 %

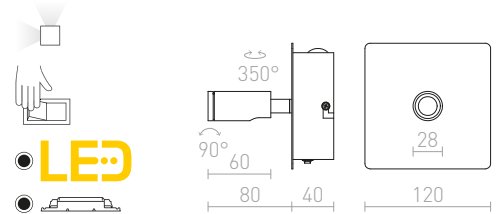

TAPIO

Foco LED de parede embutido em base retangular

TAPIO I SQ NA PAREDE

230 V LED 4,5 W 3000 K 350 lm Ra 80

R13423 preto

€ 88

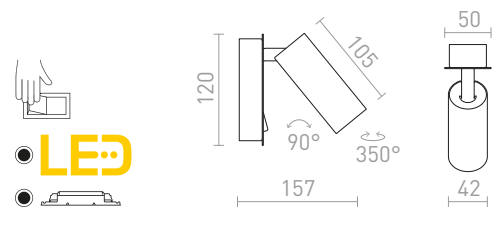

MIG

Foco LED elegante de parede com interruptor adequado para uso no quarto. O cabo pode ser ligado ao bocal usando um ilhós na base. O cabo não está incluído.

MIG NA PAREDE

230 V LED 3 W $\angle 30^\circ$ 3000 K 150 lm Ra 80

R13644 branco

€ 78

R13645 preto

€ 78

R13646 níquel mate

€ 78

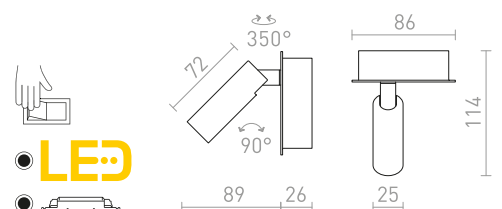



EKE

Luminária de parede com foco LED em braço articulado e interruptor na base.

EKE NA PAREDE

230 V LED 3 W $\angle 60^\circ$ 3000 K 100 lm Ra 80

R12944 branco

€ 68

R12945 preto

€ 68

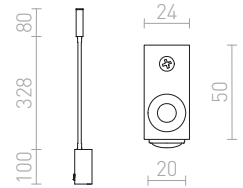
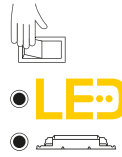

VALE

Lâmpada LED de parede com braço articulado com interruptor na base. O cabo pode ser ligado ao bocal usando um ilhó na base. O cabo não está incluído.

VALE NA PAREDE

230 V LED 3 W $\angle 30^\circ$ 3000 K 150 lm Ra 80

R13647 branco

€ 98

R13648 preto

€ 98

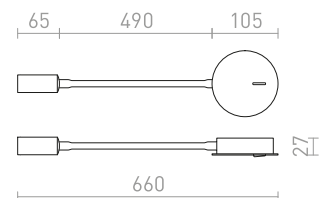
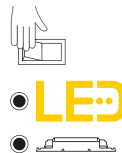



FRISCO

Luminária de parede LED em braço flexível com interruptor na base. O foco retangular fornece uma ampla dispersão de luz.

FRISCO W NA PAREDE

230 V LED 4,2 W $\angle 120^\circ$ 3000 K 300 lm Ra 80

R12942 preto

€ 120



LED

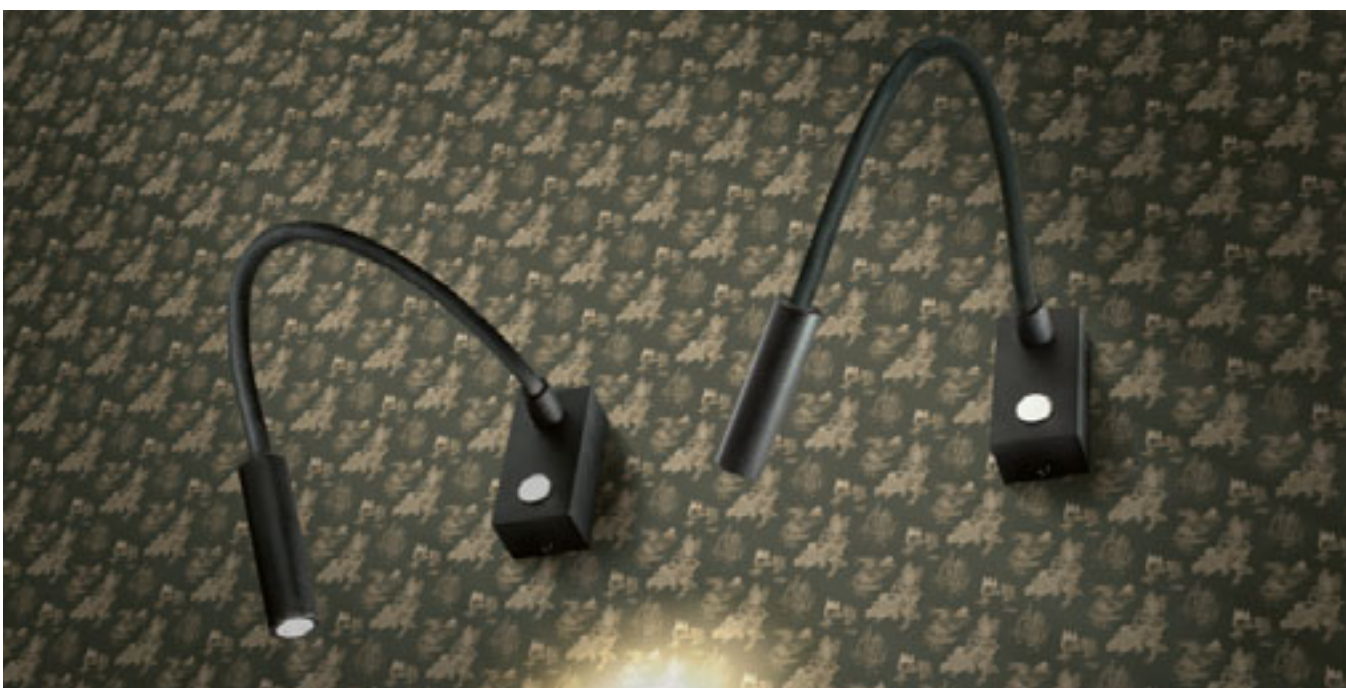
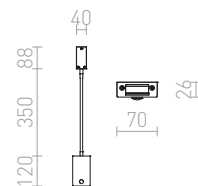

AIM

Luminária de parede LED com braço flexível. O interruptor de toque está localizado na base da luminária.

AIM COM BRAÇO ARTICULADO

230 V LED 3 W $\angle 45^\circ$ 3000 K 180 lm Ra 80

R10541 preto

€ 158



LED

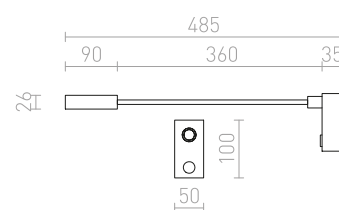



POINT

Foco LED com braço articulado. O botão de alavanca está localizado na parte inferior da base.

POINT NA PAREDE

230 V LED 3 W $\angle 40^\circ$ 3000 K 240 lm Ra 80

R11758 níquel mate

€ 68 %

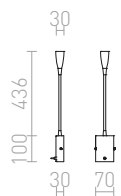



VERSA

Foco LED com braço articulado. O botão de alavanca está localizado na parte inferior da base.

VERSA NA PAREDE

230 V LED 3 W $\angle 40^\circ$ 3000 K 240 lm Ra 80

R10602 níquel mate

€ 98

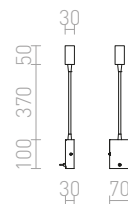

SHOW

Foco LED em braço articulado para montagem em parede.

SHOW NA PAREDE

230 V LED 3 W 3000 K 240 lm Ra 80

R12896 branco/cromo

€ 88

R12897 preto/cromo

€ 88

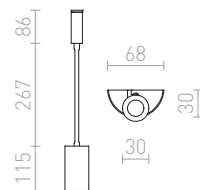

BOB

Foco com LED integrado com braço articulado. O interruptor de alavanca está localizado na base.

BOB COM BRAÇO ARTICULADO

230 V/500 mA LED 3 W $\angle 45^\circ$ 3000 K 180 lm Ra 80

R10538 cromo

€ 129





KAYA

Luminária de parede com abajur metálico em braço articulado e interruptor na base, para fontes de luz E27.

KAYA NA PAREDE

230 V E27 28 W

R12898 branco/níquel mate

€ 58

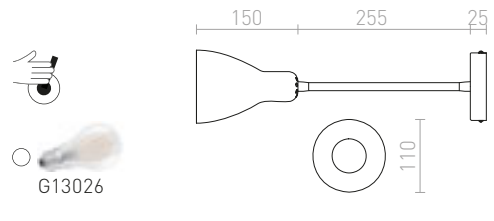

FRISCO

Luminária LED em braço articulado. Fixação com braçadeira em forma de C para mesas, etc. O interruptor está localizado no cabo. O foco retangular fornece uma ampla dispersão de luz.

FRISCO D COM SUPORTE PARA MESA

230 V LED 4,2W $\angle 120^\circ$ 3000 K 300 lm Ra 80

R12941 preto

€ 78

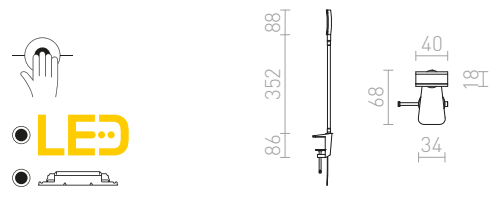

FLAP

Luminária pequena de parede com LED em braço articulado, um foco circular e interruptor na base.

FLAP NA PAREDE

230 V LED 4,2W $\angle 120^\circ$ 3000 K 100 lm Ra 80

R12943 cromo

€ 78

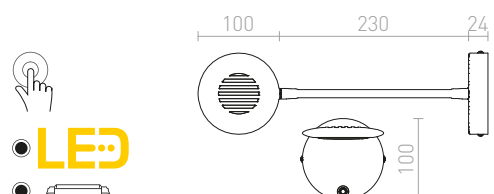





BELENOS

Foco cilíndrico minimalista para fontes de luz GU10 sobre base redonda. As molas ligadas ao casquilho permitem o uso de fontes de luz de vários comprimentos.

BELENOS TETO

230 V LED GU10 9 W

R13363 branco

€ 48

R13364 preto

€ 48

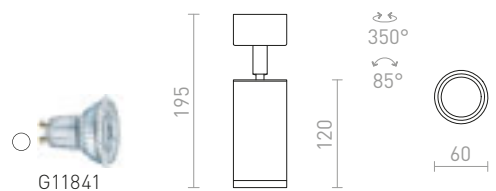



OPTIMUS

Foco de teto cilíndrico com possibilidade de ajuste do cone de luz mediante sistema de zoom de 10-50°. O foco é adequado para fontes de luz LED com um casquilho GU10. Use fontes de luz com um ângulo de feixe de 120° na luminária para evitar sombras indesejadas.

OPTIMUS TETO

230 V LED GU10 9 W \angle 10-50°

R13779 branco

€ 58 NEW

R13780 preto

€ 58 NEW

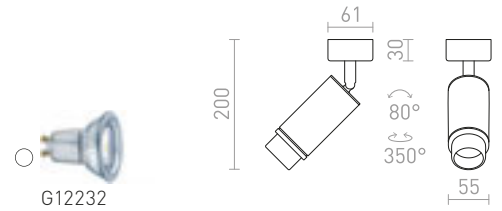

BOGARD

Foco direcional tubular LED de teto ajustável.

BOGARD TETO

230 V LED 5 W \angle 40° 3000 K 414 lm Ra 80

R12497 mate preto

€ 78

R12498 níquel mate

€ 78 ➔

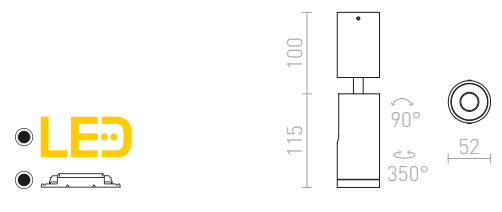

BOGARD

Luminária de teto LED com um foco fixo e um ajustável.

BOGARD TWIN TETO

230 V LED 2x5 W \angle 40° 3000 K 700 lm Ra 80

R12499 mate preto

€ 138

R12500 níquel mate

€ 88 %

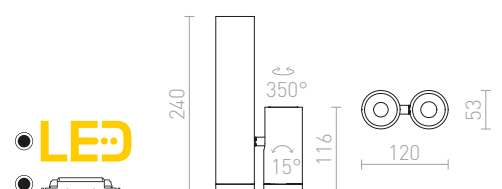



DARIO

Luminária cilíndrica direcional com casquilho GU10 para fontes de luz LED, incluindo um tom decorativo de latão preto escovado. Diferentes combinações de cores estão disponíveis comprando tons adicionais em outras cores.

DARIO TETO

230 V GU10 9 W

R13867 branco/latão escovado

€ 68

NEW

R13868 preto/latão escovado

€ 68

NEW

R13869 latão escovado

€ 78

NEW

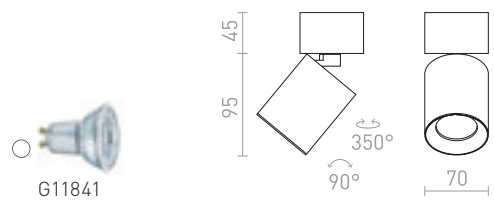
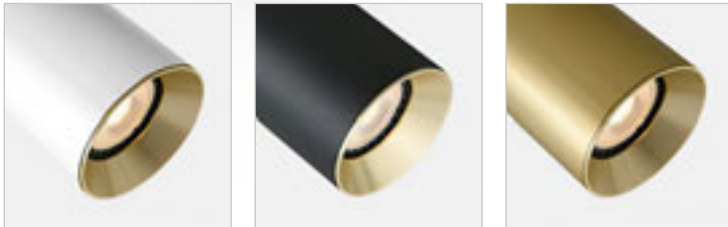

DARIO

Tonalidade decorativa interna de metal em várias cores para a luz DARIO.

DARIO ANEL DECORATIVO

R13876 branco

€ 9.80

NEW

R13877 preto

€ 9.80

NEW

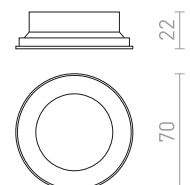
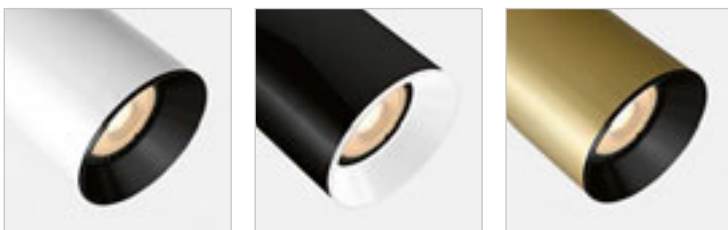



PIXIE

Luminária inclinada na base para fontes de luz LED GX53 de baixo consumo energético.

PIXIE DIRECIONAL

230 V LED GX53 7 W

R11772 branco/cromo

€ 138

R11773 preto/cromo

€ 138

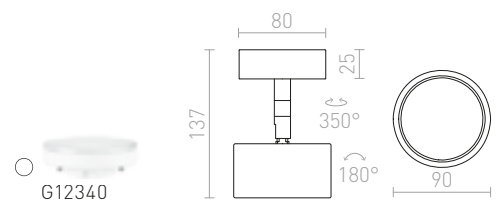



CELEIA

Foco de metal cilíndrico para uso com fonte de luz E27 adequada.

CELEIA MONTADO À SUPERFÍCIE

230 V E27 40 W

R13901 mate branco/níquel mate

€ 48

NEW

R13902 mate preto/cobre escovado

€ 48

NEW

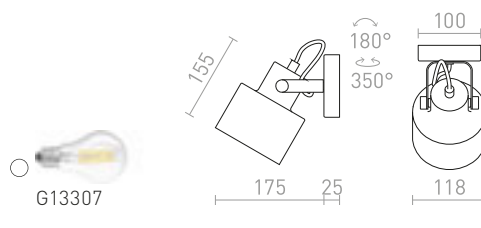

BAROQUE

Luminária de parede pequena para fontes de luz com casquilho E27, com um foco amplo e interruptor na base.

BAROQUE NA PAREDE

230 V E27 28 W

R12986 preto/cromo

€ 58

%

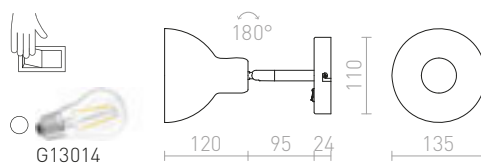



AGNETA

Cortina de metal giratória redonda com base, para uso com uma fonte de luz E27 adequada.

AGNETA MONTADO À SUPERFÍCIE

230 V E27 40 W

R13893 branco

€ 58 NEW

R13894 preto

€ 58 NEW

R13895 latão escovado/preto

€ 78 NEW

R13896 cobre escovado/preto

€ 78 NEW

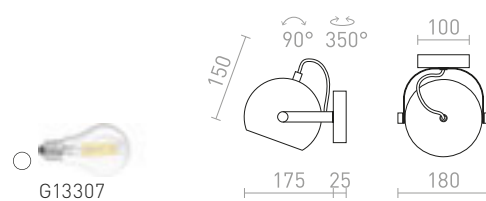

G13307



JOLI

Foco inclinável em plástico para fontes de luz LED com casquilho GU10.

JOLI I NA PAREDE

230 V LED GU10 10 W

R13556 preto

€ 48

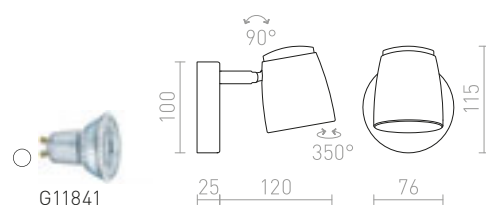

G11841





CASSIE

Luminária de parede/teto com foco inclinável.

CASSIE NA PAREDE

230 V/12 V G53 50 W

R10591 níquel mate

€ 68 %

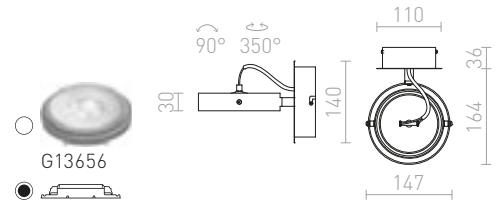

BUGSY

Luminária de parede com abajur de vidro espelhado e base cromada.

BUGSY I NA PAREDE

230 V GU10 50 W

R10521 vidro cromado

€ 48 %

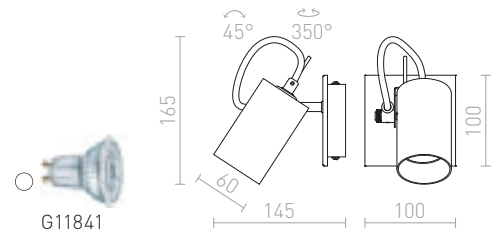

IP44

ORIT

Foco inclinável em alumínio para exterior equipado com LED de 6W. Luz inclinável em apenas um eixo.

ORIT NA PAREDE

230 V LED 6 W $\angle 80^\circ$ 3000 K 315 lm Ra 80 IP44

R12033 alumínio

€ 88

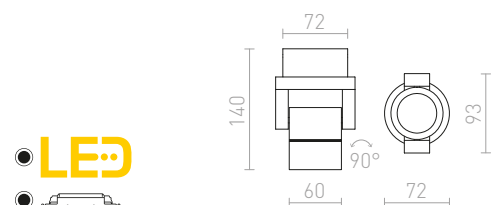



MARVEL

Luminária angular de alumínio para duas fontes de luz GU10 que podem ser inclinadas individualmente em base central.

MARVEL II DIRECIONAL

230 V GU10 2x50 W

R10171 alumínio

€ 48 %



G11841

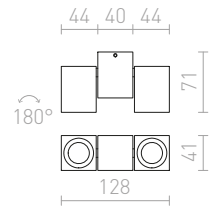

MARVEL

Luminária angular de alumínio para duas fontes de luz GU10.

MARVEL DIRECIONAL

230 V GU10 2x50 W

R10167 alumínio

€ 48 %



G11841

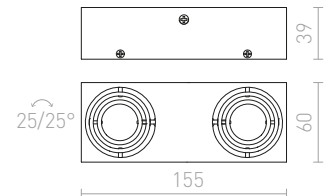

REDO

Foco direcional de alumínio maciço.

REDO DIRECIONAL

230 V GU10 50 W

R10173 alumínio

€ 48 ➔



G11841

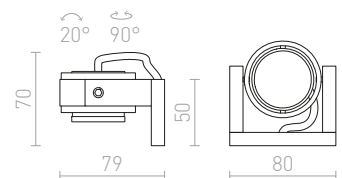





CANDEEIROS DE MESA

DECORATIVO	340-351
ESCRITÓRIO	352-359

CANDEEIROS DE MESA DECORATIVO

340-351



CAMINO
340-341



CAMINO
340-341



HEIDI
340-341



ALGOT
342-343



AMERICANO
342-343



LAURA
342-343



EL PASO
344-345



ZUMBA
344-345



FLORINA 38/15
344-345



PLAZA S
346-347



PLAZA M
346-347



PERTH
346-347



MONACO
346-347



LULU
348-349



BROADWAY
348-349



MINNIE
348-349



ESPLANADE
350-351



RITZY
350-351



EDIKA
350-351



GARDETTE
350-351

CANDEEIROS DE MESA ESCRITÓRIO

352-359



MONTANA
352-353



GARBO
352-353



ANIKA
352-353



CELEIA
352-353



ROSITA
354-355



BUGSY
354-355



JOLI
354-355



FADO
356-357



VIPER TL
356-357



COZY
356-357



TAPIO
356-357



FRISCO T
358-359



FRISCO D
358-359



IBIS
358-359



CAMINO

Candeeiro de mesa minimalista, de forma cilíndrica, que inclui um abajur têxtil. Cada base tem o seu acabamento exclusivo.

CAMINO DE MESA COM ABAJUR

230 V E27 28 W

R13294 branco/terazzo decor

€ 78

R13295 branco/cimento

€ 78



G13026

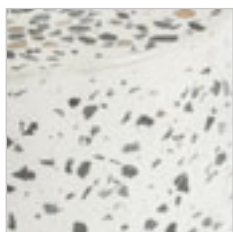
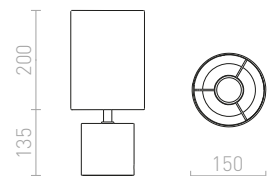

CAMINO

Candeeiro de mesa minimalista de forma cilíndrica, para fontes de luz decorativas adequadas. Cada base tem o seu acabamento exclusivo.

CAMINO DE MESA

230 V E27 28 W

R13293 terazzo decor

€ 48



G13311

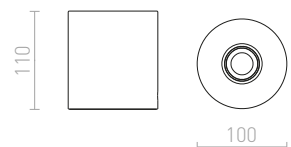

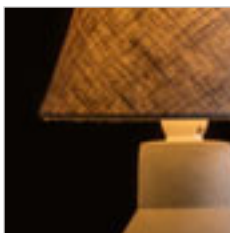

HEIDI

Candeeiro de mesa decorativo de cimento com abajur têxtil para fontes de luz E14.

HEIDI DE MESA

230 V E14 12 W

R12379 natural/cimento

€ 48



G12243

118
127

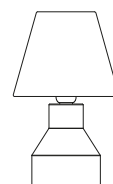



ALGOT

Base de candeeiro de mesa para uso com uma fonte de luz decorativa E27 adequada.

ALGOT DE MESA

230 V E27 40 W

R13907 preto/cobre escovado

€ 28 **NEW**



G13459

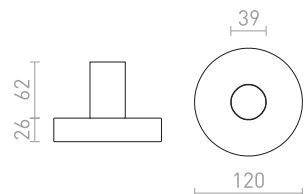



AMERICANO

Candeeiro de mesa cilíndrico com acabamento em cobre.

AMERICANO DE MESA

230 V E27 28 W

R13322 folha de cobre/cobre

€ 120 %



G13026

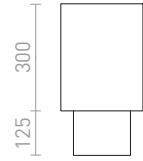

LAURA

Candeeiro de mesa decorativo com um abajur têxtil.

LAURA DE MESA

230 V E27 28 W

R13323 branco

€ 68

R13324 cinzento bege

€ 58

R13325 preto

€ 68

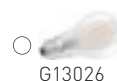

G13026

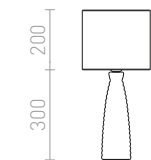



FLORINA

Candeeiro de mesa trançado para iluminação decorativa.

FLORINA 38/15 DE MESA

230 V E27 11 W

R13449 natural

€ 98 ➔

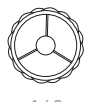
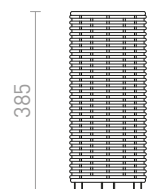



EL PASO

Candeeiro de mesa de bambu com um abajur têxtil. Este artigo é entregue desmontado.

EL PASO DE MESA

230 V E14 11 W

R13338 cinzento/bambu

€ 68 %



G12243

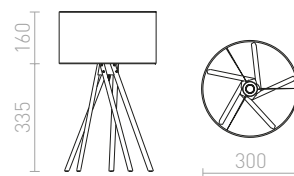

ZUMBA

Candeeiro de mesa pequeno sobre uma base de madeira com um abajur de plástico. Este artigo é entregue desmontado.

ZUMBA DE MESA

230 V E14 11 W

R13320 PVC branco/madeira/cromo

€ 48 %



G11849

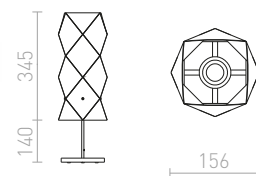



PLAZA

Candeeiro de mesa com abajur têxtil texturado.

PLAZA S DE MESA

230 V E27 42 W

R11973 branco/cromo

€ 178 %

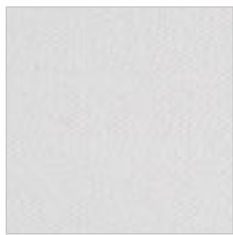
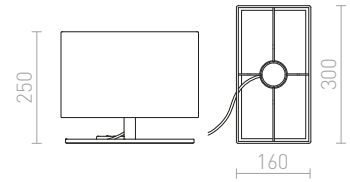

PLAZA M DE MESA

230 V E27 42 W

R11983 branco/cromo

€ 238

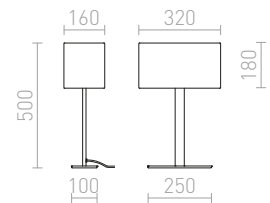

MONACO

Candeeiro de mesa compacto com abajur têxtil preto sobre base cromada.

MONACO DE MESA

230 V E27 28 W

R12040 preto/cromo

€ 38 →

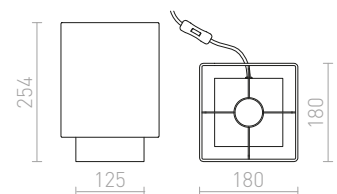

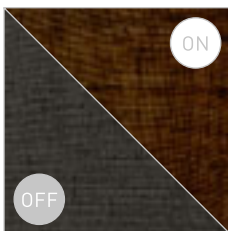
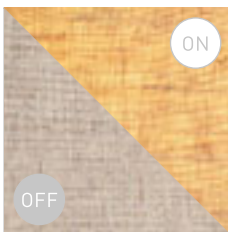

PERTH

Candeeiro de mesa com abajur quadrado em tecido e base metálica.

PERTH DE MESA

230 V E27 15 W

R13663 bege/branco

€ 150

R13664 preto/preto

€ 150



G13307

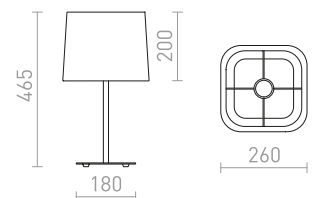



MINNIE

Candeeiro subtil de mesa com um abajur têxtil.

MINNIE DE MESA

230 V E14 15 W

R13274 preto/cromo

€ 28 %



G12243

130
110

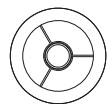
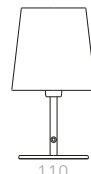

132



BROADWAY

Candeeiro de mesa com um abajur têxtil texturado branco e base cromada.

BROADWAY DE MESA

230 V E27 42 W

R11986 branco/cromo

€ 178



G13026

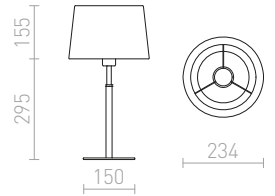

LULU

Candeeiro de mesa com abajur cónico têxtil e casquilho E27. A base tem uma elegante combinação de cromo e preto.

LULU DE MESA

230 V E27 28 W

R12464 branco/preto/cromo

€ 150

R12465 preto/cromo

€ 150



G13026

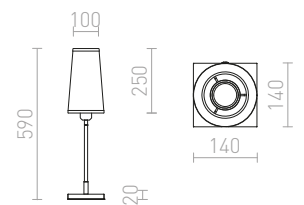



EDIKA

Candeeiro de mesa em níquel com perna telescópica e abajur têxtil com casquilho E27.

EDIKA DE MESA

230 V E27 42 W

R12665 castanho/níquel mate

€ 150

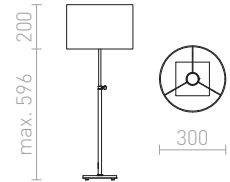

GARDETTE

Candeeiro de mesa para tripés com ajuste de altura e abajur têxtil e casquilhos E27.

GARDETTE DE MESA

230 V E27 42 W

R12488 preto/alumínio

€ 158

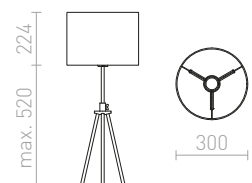



ESPLANADE

Candeeiro de mesa com abajures têxteis duplos e altura regulável.

ESPLANADE DE MESA

230 V E27 42 W

R12484 preto transparente/branco/cromo

€ 278



G13026

max. 525 218

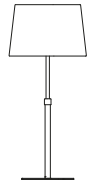

327



RITZY

Candeeiro de mesa com ajuste para regular a altura, em preto e cromo. Vem com abajur têxtil e casquilho E27.

RITZY DE MESA

230 V E27 42 W

R12486 preto/cromo

€ 178



G13026

max. 550 150

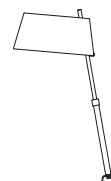

400

330



ANIKA

Candeeiro de mesa de metal com braço ajustável para uso com uma fonte de luz E27 adequada.

ANIKA DE MESA

230 V E27 40 W

R13905 mate branco/níquel mate

€ 68

NEW

R13906 mate preto/níquel mate

€ 68

NEW

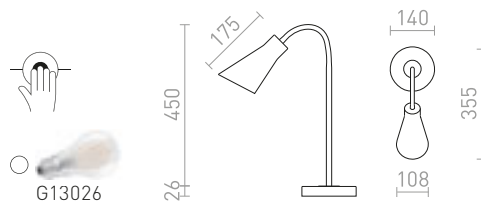

CELEIA

Candeeiro de mesa cilíndrico de metal para uso com fonte de luz E27 adequada.

CELEIA DE MESA

230 V E27 40 W

R13903 mate branco/níquel mate

€ 120

NEW

R13904 mate preto/cobre escovado

€ 120

NEW

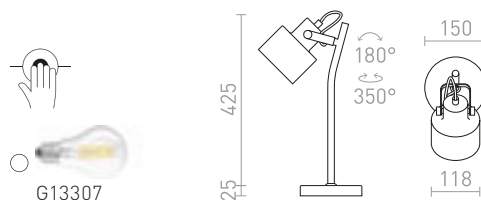



GARBO

Candeeiro de mesa de metal com casquilho E27.

GARBO DE MESA

230 V E27 28 W

R12675 preto/cromo

€ 68

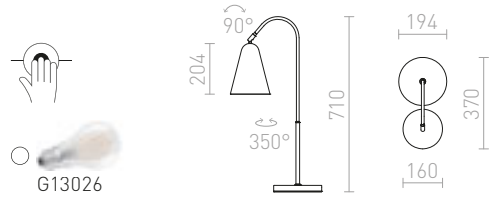

MONTANA

Candeeiro de mesa com braço ajustável e abajur têxtil.

MONTANA DE MESA

230 V E27 28 W

R13283 branco/preto/cromo

€ 320

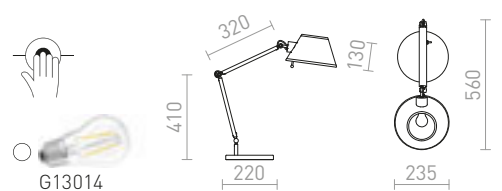

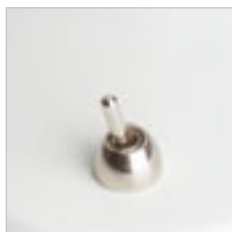

ROSITA

Candeeiro de mesa de estilo retro para fontes de luz GU10 com baixo consumo de energia.

ROSITA DE MESA

230 V LED GU10 9 W

R12511 branco/cinza prata

€ 120

R12512 preto/ouro

€ 120



G11841

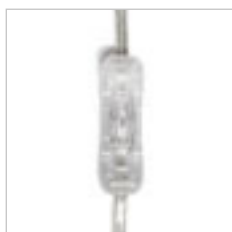
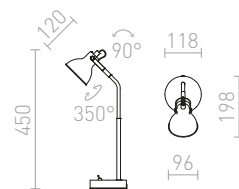

BUGSY

Candeeiro de mesa com abajur de vidro espelhado, inclinável em um eixo.

BUGSY DE MESA

230 V GU10 50 W

R10519 vidro cromado

€ 120



G11841

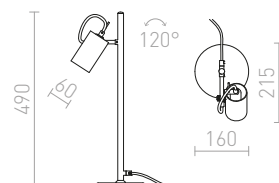



JOLI

Candeeiro de mesa em plástico para fontes de luz LED com casquilho GU10.

JOLI DE MESA
230 V LED GU10 10 W

R13558 preto

€ 58



G11841

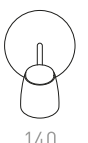
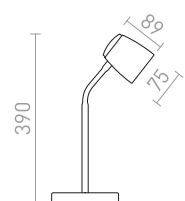



VIPER

Candeeiro de mesa com design elegante, um foco LED ajustável preto, cabo têxtil vermelho e detalhes cromados.

VIPER TL DE MESA

230 V LED 3 W $\angle 60^\circ$ 3000 K 100 lm Ra 80

R12462 preto/cromo

€ 178 

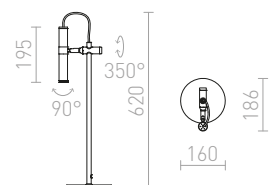



FADO

Candeeiro de mesa em design angular com um foco LED ajustável.

FADO DE MESA

230 V LED 3 W $\angle 45^\circ$ 3000 K 110 lm Ra 80

R12474 preto

€ 120 %

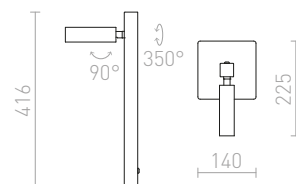

TAPIO

Candeeiro de mesa LED com foco cilíndrico direcional.

TAPIO DE MESA

230 V LED 4,5 W 3000 K 350 lm Ra 80

R13429 preto

€ 120

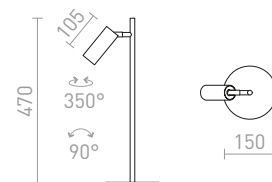

COZY

Elegante candeeiro de mesa LED sobre tripé em acabamento metálico mate. O transformador faz parte do adaptador do casquilho.

COZY DE MESA

230 V LED 3,5 W 3000 K 240 lm Ra 80

R11759 níquel mate

€ 78 %

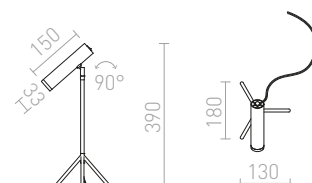
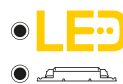



FRISCO

Candeeiro de mesa LED em braço articulado com interruptor na base. O foco retangular fornece uma ampla dispersão de luz.

FRISCO T DE MESA

230 V LED 4,2W $\angle 120^\circ$ 3000 K 300 lm Ra 80

R12940 preto

€ 120 %

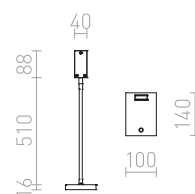

FRISCO

Luminária LED em braço articulado. Fixação com braçadeira em forma de C para mesas, etc. O interruptor está localizado no cabo. O foco retangular fornece uma ampla dispersão de luz.

FRISCO D COM SUPORTE PARA MESA

230 V LED 4,2W $\angle 120^\circ$ 3000 K 300 lm Ra 80

R12941 preto

€ 78 %

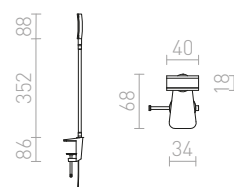



IBIS

Candeeiro de mesa de escritório com LED SMD integrado. A lâmpada é regulável com os botões de toque na base. Com porta USB.

IBIS DE MESA

230 V LED 8 W 3000 K 532 lm Ra 81

R10608 preto

€ 138

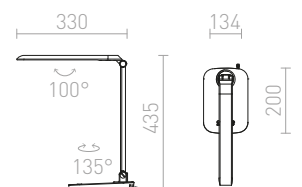



CANDEEIROS DE PÉ

DECORATIVO

364-371

PARA LEITURA

372-375



CANDEEIROS DE PÉ DECORATIVO

364-371



DANTE
364-365



NAUTIC
364-365



RITZY
364-365



BOULOGNE
366-367



GARDETTE
366-367



ESPLANADE
366-367



PERTH
366-367



EDIKA
368-369



PLAZA
368-369



LARGO
368-369



ETESIAN
370-371



LULU
370-371

CANDEEIROS DE PÉ PARA LEITURA

372-375



ICAR
372-373



ROSITA
372-373



PRAGMA
372-373



VARIA
372-373



VIPER FL
374-375



BUGSY
374-375



FADO
374-375



RITZY

Candeeiro de pé com ajuste para regular a altura, em preto e cromo. Vem com abajur têxtil e casquilho E27.

RITZY DE PÉ
230 V E27 42 W

R12487 preto/cromo

€ 645 %



G13029

max. 1495 210



660

420



NAUTIC

Candeeiro de pé de estilo retro sobre tripé e foco ajustável para fontes de luz E27.

NAUTIC DE PÉ
230 V E27 20 W

R13394 preto/cromo

€ 215



G13020

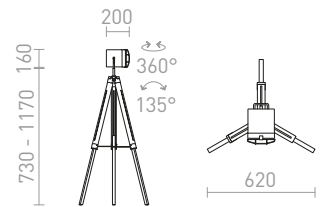

DANTE

Candeeiro de pé de design maciço adequado para interiores espaçosos. Combinação de madeira, metal e abajur têxtil.

DANTE DE PÉ
230 V E27 25 W

R13653 preto/madeira

€ 680



G13461

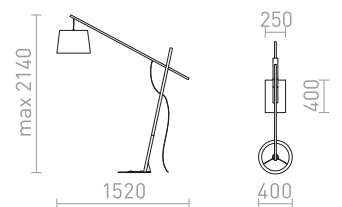

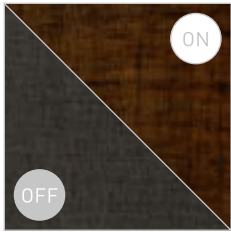
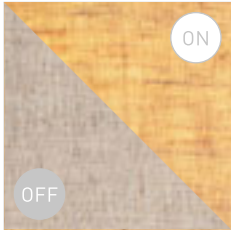

PERTH

Candeeiro de pé com abajur angular em tecido e base metálica.

PERTH DE PÉ

230 V E27 20 W

R13665 bege/branco

€ 290

R13666 preto/preto

€ 290



G13029

1550



270



370



BOULOGNE

Suporte de tripé com abajur de fita dupla em preto.

BOULOGNE DE PÉ

230 V E27 28 W

R12674 preto

€ 335 →



G13461

1500

285



550



GARDETTTE

Candeeiro de pé sobre tripé permanente com ajuste de altura e abajur têtil para casquilhos E27.

GARDETTTE DE PÉ

230 V E27 42 W

R12489 preto/alumínio

€ 460



G13029

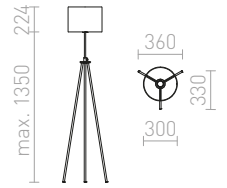

ESPLANADE

Candeeiro de pé com suporte ajustável e abajur têtil duplo.

ESPLANADE DE PÉ

230 V E27 42 W

R12485 preto transparente/branco/cromo

€ 620



G13029

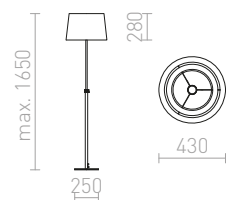



PLAZA

Candeeiro de pé com abajur têxtil texturado.

PLAZA DE PÉ
230 V E27 42 W

R11984 branco/cromo

€ 620 →



G13026

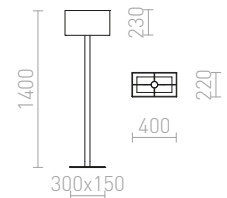

EDIKA

Candeeiro de pé em níquel com perna telescópica e abajur têxtil com casquilho E27.

EDIKA DE PÉ
230 V E27 42 W

R12666 castanho/níquel mate

€ 215 →



G13026

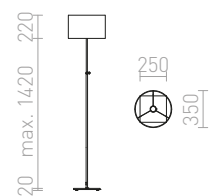



LARGO

Candeeiro de pé de tecido com base cromada.

LARGO DE PÉ
230 V E27 20 W

R13395 branco/cromo

€ 88

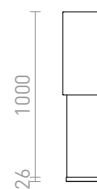



LULU

Candeeiro de pé com abajur cônico têxtil e casquilho E27. A base tem uma elegante combinação de cromo e preto.

LULU DE PÉ

230 V E27 28 W

R12466 branco/preto/cromo

€ 258

R12467 preto/cromo

€ 258



G13029

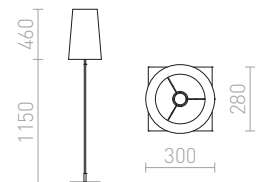



ETESIAN

Candeeiro de pé subtil com abajur têxtil e casquilho E27.

ETESIAN DE PÉ

230 V E27 28 W

R12468 branco

R12470 preto

€ 178

€ 188

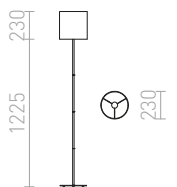



PRAGMA

Candeeiro de pé com casquilho E27.

PRAGMA DE PÉ

230 V E27 28 W

R12989 preto/cromo

€ 150



G13014

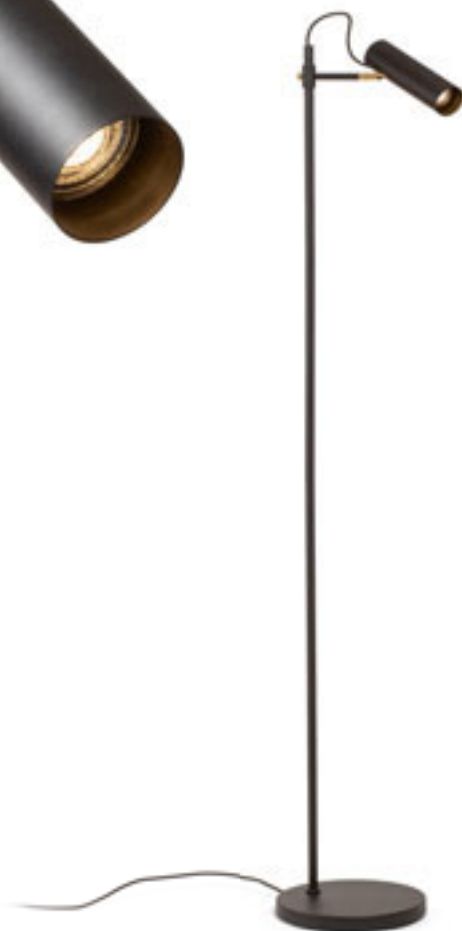
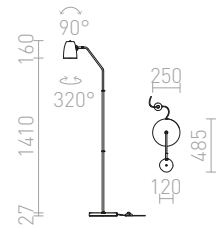

VARIA

Luminária de pé elegante com refletor cilíndrico para fonte de luz LED com casquilho GU10. A chave está localizada na parte traseira do refletor.

VARIA DE PÉ

230 V LED GU10 9 W

R13660 preto/latão

€ 215



G11841

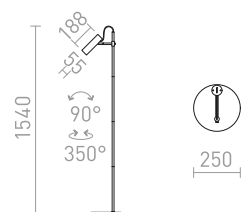



ROSITA

Candeeiro de pé de estilo retro para fontes de luz E27.

ROSITA DE PÉ

230 V E27 12 W

R12513 branco/cinza prata

€ 150 %

R12514 preto/ouro

€ 178 %



G13014

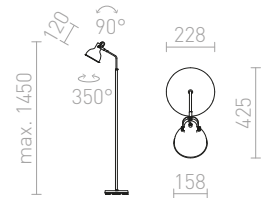

ICAR

Candeeiro de pé com abajur têxtil e casquilho E27.

ICAR DE PÉ

230 V E27 15 W

R12419 preto/ouro

€ 238



G13014

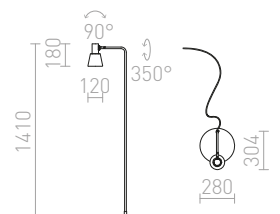



VIPER

Candeeiro de pé cromado com dois focos LED pretos ajustáveis, que podem ser controlados individualmente por interruptores colocados sobre cabos têxteis vermelhos. Ambos os cabos possuem tomadas individuais.

VIPER FL DE PÉ

230 V LED 2x3 W $\angle 60^\circ$ 3000 K 200 lm Ra 80

R12463 preto/cromo

€ 268 %

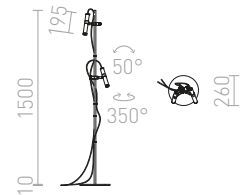
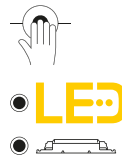

FADO

Candeeiro de pé com design angular e dois focos LED ajustáveis.

FADO DE PÉ

230 V LED 2x3 W $\angle 45^\circ$ 3000 K 220 lm Ra 80

R12475 preto

€ 290 %

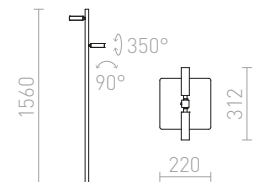

BUGSY

Candeeiro de pé com abajures de vidro espelhado. Cada abajur pode ser inclinado em um eixo.

BUGSY DE PÉ

230 V GU10 3x50 W

R10520 vidro cromado

€ 215 %

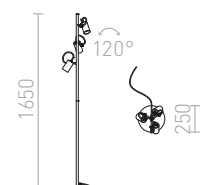
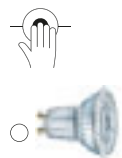

G11841





LUZES EMBUTIDAS

MODULAR	388-395
LED DE CASA DE BANHO	396-401
CASA DE BANHO	402-409
SEM MOLDURA	410-413
GEDSO	414-425
DECORATIVO	426-429
CONJUNTOS	430-441
CIRCULAR	442-445
ANGULAR	446-449
FINO	450-465
RETANGULAR	466-467
PARA PAREDE	468-485



EMBUTIDO MODULAR



SHARM BASE
388-389



SHARM PLUS
388-389



SHARM R I
390-391

388-395



SHARM R II
390-391



SHARM R III
390-391



SHARM SQ I
392-393



SHARM SQ II
392-393



SHARM SQ III
392-393



RINO
394-395



WATERBOY R
394-395



WATERBOY SQ
394-395



NAVY
394-395

EMBUTIDO LED DE CASA DE BANHO



INEZ R
396-397



INEZ SQ
396-397



MERGO R
396-397

396-401



BELLA LED
396-397



AMIGA R
398-399



AMIGA SQ
398-399



TOLEDO R
398-399



TOLEDO SQ
398-399



OWEN
398-399



BELI R 10
400-401



BELI R 21
400-401



BELI SQ 10
400-401



BELI SQ 21
400-401

EMBUTIDO CASA DE BANHO



402-409

MAJESTIC
402-403

EQUA
402-403

APRIORI
402-403



BERMUDA
402-403

ACUA
404-405

BELLA GU10
404-405

VERO
404-405

ASTOR R
406-407



ASTOR SQ
406-407

SPLASH R
406-407

SPLASH SQ
406-407

LEROY R
408-409

LEROY SQ
408-409



INCA R
408-409

ISLA
408-409

BRAN
408-409

EMBUTIDO SEM MOLDURA



410-413

IPSO SQ frameless
410-411

IPSO R frameless
410-411

IPSO R
410-411



COIMBRA
410-411

ELECTRA I
412-413

ELECTRA II
412-413

EMBUTIDO GESSO



DAG R 83
414-415



DANDY R
414-415



QUO R
414-415

414-425



QUO R II
414-415



DAG SQ
416-417



DANDY SQ
416-417



QUO SQ I
416-417



QUO SQ II
416-417



MIA R
418-419



DAN SQ 80
418-419



DINGO S
420-421



DINGO GU10 II
420-421



DINGO R
422-423



DINGO II
422-423



DINGO TUB
424-425



DINO SQ G53
424-425



DINO SQ GU10
424-425

EMBUTIDO DECORATIVO



KAY R
426-427



KAY SQ
426-427



BIANCA SQ
426-427

426-429



ERGO
428-429



REWA
428-429



SPARKLE
428-429

EMBUTIDO CONJUNTOS



KELLY LED
430-431



KELLY LED
430-431



TOMBOY
430-431

430-441



ZIZI I
432-433



ZIZI II
432-433



PASADENA G53 R I
432-433



PASADENA G53 SQ II
434-435



GRANADA R
432-433



GRANADA SQ
434-435



PASADENA G53 SQ I
434-435



BONDY I
436-437



BONDY II
436-437



BONDY III
436-437



LIZARD I
436-437



MONE I
438-439



MONE II
438-439



MONE III
438-439



FIZZ III
438-439



PASADENA GU10 R
440-441



PASADENA GU10 SQ I
440-441



PASADENA GU10 SQ II
440-441



MURO SQ
440-441

EMBUTIDO CIRCULAR



LOOKER 17
442-443



SPRAY 9
442-443



SPRAY 11
442-443

442-445



MIRO
442-443



VIP
444-445



SOBER
444-445



TOPIC R
444-445

EMBUTIDO ANGULAR

446-449



TECH I
446-447



LEDA
446-447



TIM
446-447



MERIKO GU10
448-449



ZURI SQ
448-449



TOPIC SQ
448-449



ACASA
448-449

EMBUTIDO FINO

450-465



BJORK R 9
450-451



BJORK R 16
450-451



BJORK R 20
450-451



BJORK SQ 9
450-451



BJORK SQ 20
450-451



DADA 9
452-453



DADA 12
452-453



DADA 17
452-453



DADA 23
452-453



DADA 30
452-453



HUER 9
454-455



HUER 17
454-455



HUER 22
454-455



HUE R 9
456-457



HUE R 17
456-457



HUE R 22
456-457



HUE SQ 9
458-459



HUE SQ 17
458-459



HUE SQ 22
458-459



HUE SQ 9
460-461



HUE SQ 17
460-461



HUE SQ 22
460-461



SOCORRO R 85
462-463



SOCORRO R 225
462-463



SOCORRO SQ 85
462-463



SLENDER SQ 8
464-465



SLENDER SQ 22
464-465



STRUCTURAL LED 40x40
464-465

EMBUTIDO RETANGULAR

466-467



STRUCTURAL LED 60x15
466-467



PESANTE 90
466-467

EMBUTIDO PARA PAREDE

468-485



IRIA R
468-469



IRIA SQ
468-469



SEGNO
468-469



ELICA R
470-471



ELICA SQ
470-471



MEMPHIS R
470-471



MEMPHIS SQ
470-471



RIO SQ
472-473



RIO R
472-473



RIO SQ O
472-473



CLUB IND
474-475



CLUB
474-475



MARCO
474-475



ASTERIA
474-475



KICK I
476-477



KICK II
476-477



KICK III
476-477



PER
478-479



AMARO
478-479



TESS SQ
478-479



INTRO L
480-481



INTRO M
480-481



RAGG
480-481



RASQ
480-481



GORDIQ S
482-483



GORDIQ M
482-483



GORDIQ L
482-483



DEJAVU SQ 9
484-485



DEJAVU SQ 14
484-485



DEJAVU RC
484-485

SHARM

Sistema Modular Profissional SHARM LED - até 2500 combinações para versões de luminárias simples, duplas ou triplas. Módulos 5/10W, 3000/4000K, lentes com ângulo de radiação de 12° e 24°, dois tipos de difusores em 5 cores diferentes, anel de ornamento curvo ou reto em 7 cores (não requerido), bases arredondadas ou iguais em 3 cores (não necessárias).

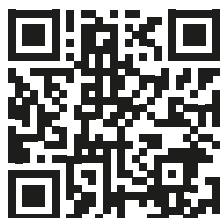

Use esse código para acessar o nosso site, onde você poderá ver e montar o seu (Spotlight) de acordo com as suas necessidades. Este configurador oferece mais de 2500 combinações para escolher.







SHARM

Luminária fixa embutida com módulo 10W LED.
Disponível em várias cores.

SHARM BASE EMBUTIDA

230 V LED 10 W $\angle 24^\circ$ 3000 K 900lm Ra 80

R13221	branco	€ 48
R13222	ouro pérola	€ 48
R13223	castanho	€ 48
R13224	preto	€ 48
R13225	cromo	€ 48
R13226	cobre	€ 48
R13227	cromo preto	€ 48

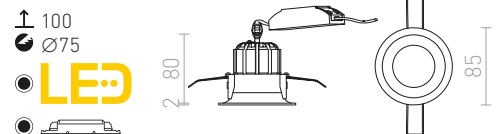

SHARM

Luminária fixa embutida com módulo 10W LED.
Disponível em várias cores.

SHARM PLUS EMBUTIDA

230 V LED 10 W $\angle 24^\circ$ 3000 K 900lm Ra 80

R13228	branco	€ 48
R13229	ouro pérola	€ 48
R13230	castanho	€ 48
R13231	preto	€ 48
R13232	cromo	€ 48
R13233	cobre	€ 48
R13234	cromo preto	€ 48

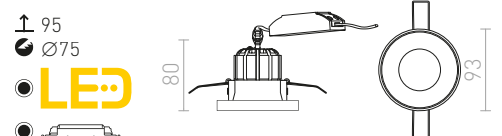



SHARM

Luminária fixa embutida com módulo 10W LED. Com este código QR pode aceder ao nosso site onde poderá montar confortavelmente até 2500 combinações ao seu gosto. www.rendl.pt/pt/configurador/

SHARM R I EMBUTIDA

230 V LED 10 W $\angle 24^\circ$ 3000 K 900 lm Ra 80

R13235 branco/cobre	€ 48
R13236 ouro pérola/castanho	€ 48
R13237 castanho/ouro pérola	€ 48
R13238 preto/cobre/cobre	€ 58
R13239 preto/preto/cobre	€ 48

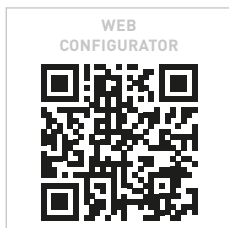
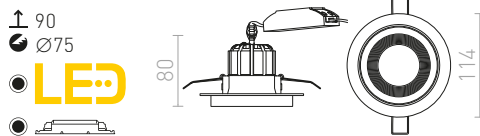

SHARM R II EMBUTIDA

230 V LED 2x10 W $\angle 24^\circ$ 3000 K 1800 lm Ra 80

R13240 branco/cobre	€ 98
R13241 ouro pérola/castanho	€ 98
R13242 castanho/ouro pérola	€ 98
R13243 preto/cobre/cobre	€ 98
R13244 preto/preto/cobre	€ 98

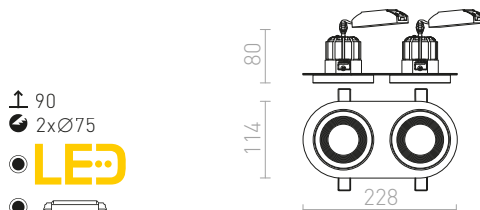



SHARM

Luminária fixa embutida com módulo 10W LED. Com este código QR pode aceder ao nosso site onde poderá montar confortavelmente até 2500 combinações ao seu gosto. www.rendl.pt/pt/configurador/

SHARM R III EMBUTIDA

230 V LED 3x10 W $\angle 24^\circ$ 3000 K 2700 lm Ra 80

R13245 branco/cobre € 138

R13246 ouro pérola/castanho € 138

R13247 castanho/ouro pérola € 138

R13248 preto/cobre/cobre € 138

R13249 preto/preto/cobre € 138

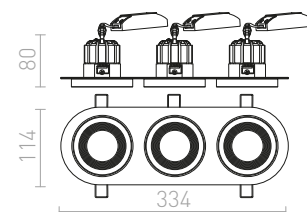
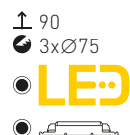
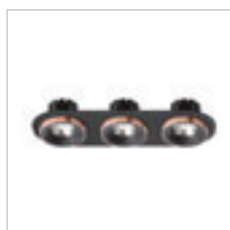
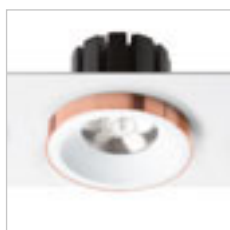



SHARM

Luminária fixa embutida com módulo 10W LED. Com este código QR pode aceder ao nosso site onde poderá montar confortavelmente até 2500 combinações ao seu gosto. www.rendl.pt/pt/configurador/

SHARM SQ I EMBUTIDA

230 V LED 10 W $\angle 24^\circ$ 3000 K 900 lm Ra 80

R13250 branco/cobre	€ 48
R13251 ouro pérola/castanho	€ 48
R13252 castanho/ouro pérola	€ 48
R13253 preto/cobre/cobre	€ 58
R13254 preto/preto/cobre	€ 48

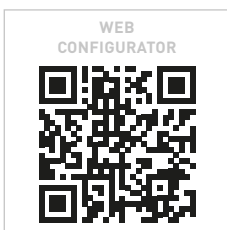
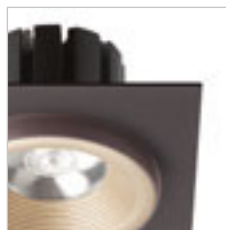
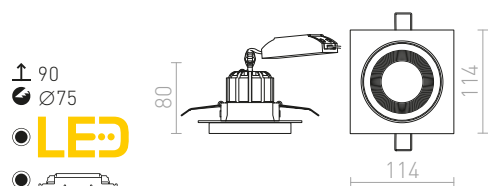

WEB
CONFIGURATOR

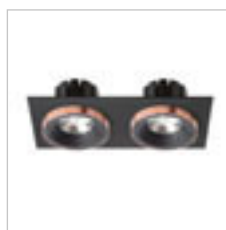

SHARM SQ II EMBUTIDA

230 V LED 2x10 W $\angle 24^\circ$ 3000 K 1800 lm Ra 80

R13255 branco/cobre	€ 98
R13256 ouro pérola/castanho	€ 98
R13257 castanho/ouro pérola	€ 98
R13258 preto/cobre/cobre	€ 98
R13259 preto/preto/cobre	€ 98

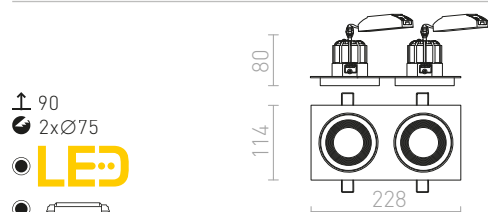



SHARM

Luminária fixa embutida com módulo 10W LED. Com este código QR pode aceder ao nosso site onde poderá montar confortavelmente até 2500 combinações ao seu gosto. www.rendl.pt/pt/configurador/

SHARM SQ III EMBUTIDA

230 V LED 3x10 W ∠24° 3000 K 2700 lm Ra 80

R13260 branco/cobre	€ 138
R13261 ouro pérola/castanho	€ 138
R13262 castanho/ouro pérola	€ 138
R13263 preto/cobre/cobre	€ 138
R13264 preto/preto/cobre	€ 138

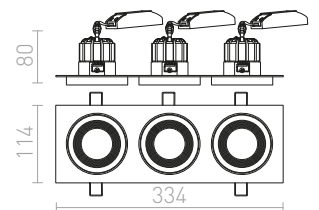
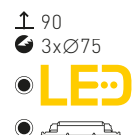



IP65



NAVY

Luminária LED maciça para instalação em tetos exteriores.

NAVY EMBUTIDA

230 V LED 15 W $\angle 36^\circ$ 2700 K 1100 lm Ra 80 IP65

R12661 branco

€ 120 %

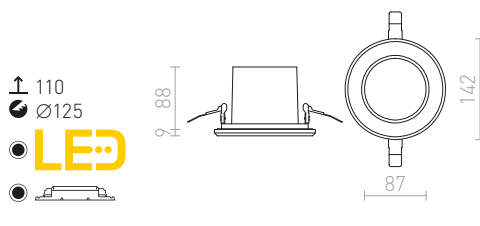

IP65



RINO

Luz de metal embutida com capas intercambiáveis adequadas para ambientes húmidos. Capa frontal vendida separadamente.

RINO

EMBTIDO SEM TAMPA

230 V LED 10 W $\angle 36^\circ$ 3000 K 760 lm Ra 80 IP65

R11682

€ 58 %

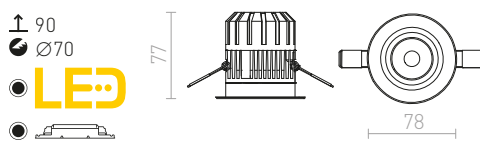

RINO

Capa frontal para RINO.

RINO CAPA DECORATIVA

R11683 branco

€ 9

R11684 cromo

€ 13.50

R11685 ouro

€ 13.50

R11686 níquel mate

€ 13.50

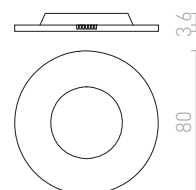



IP65

WATERBOY

Luz embutida de alumínio LED adequada para ambientes húmidos. Disponível em várias versões.

WATERBOY SQ

230 V LED 10 W $\angle 40^\circ$ 3000 K 550 lm Ra 80 IP65

- R11728** mate branco € 78
- R11729** níquel mate € 88
- R11730** cromo € 88
- R11741** mate preto € 78

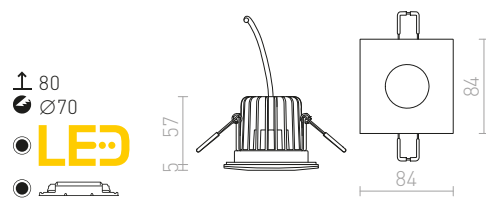

IP65

WATERBOY R

230 V LED 10 W $\angle 40^\circ$ 3000 K 550 lm Ra 80 IP65

- R11725** mate branco € 78
- R11726** níquel mate € 78
- R11727** cromo € 78
- R11740** mate preto € 78

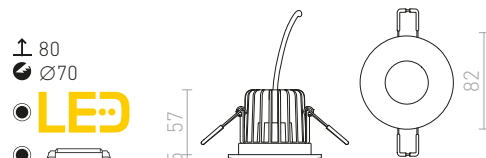



IP65



BELLÁ

Iluminação LED embutida de casa de banho para tetos falsos em gesso cartonado com reflector embutido.

BELLÁ LED EMBUTIDA

230 V LED 11 W $\angle 40^\circ$ 3000 K 940 lm Ra 90 IP65

R13602 branco

€ 68

± 70
● Ø68

● LED

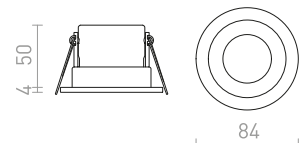



IP44



IP44



INEZ

Luz LED com uma baixa profundidade de reentrância. A luminária é adequada para a inserção em móveis.

INEZ R

12V= LED 3W 3000K 170lm Ra80 IP44

R10586 cromo

€ 35

↑ 15
 ● Ø56

● LED

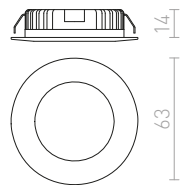

INEZ SQ

12V= LED 3W 3000K 170lm Ra80 IP44

R10587 cromo

€ 22 %

↑ 15
 ● Ø56

● LED

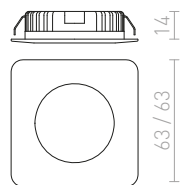

IP44



MERGO

Luz embutida LED para ambientes húmidos.

MERGO R EMBUTIDA

230V LED 6,5W 3000K 535lm Ra80 IP44

R10572 cromo

€ 48 %

↑ 75
 ● Ø72

● LED

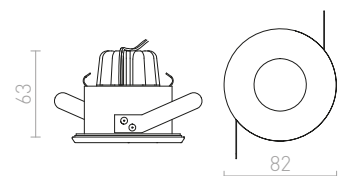



AMIGA

Luminária embutida com LED integrado para ambientes húmidos. Regulação da intensidade da luz TRIAC.

AMIGA R DIMM

230 V LED 8 W $\angle 40^\circ$ 3000 K 580 lm Ra 80 IP65

R10565 branco

€ 129

± 110

● Ø96

● LED

● regulável

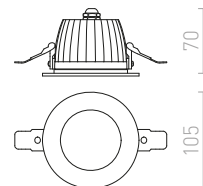

AMIGA SQ DIMM

230 V LED 8 W $\angle 40^\circ$ 3000 K 580 lm Ra 80 IP65

R10566 branco

€ 129

± 110

● Ø96

● LED

● regulável

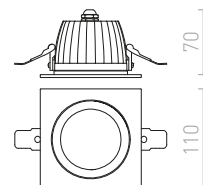

TOLEDO

Luminária embutida LED para tetos de gesso adequada para ambientes húmidos.

TOLEDO R

230 V LED 7 W $\angle 60^\circ$ 3000 K 514 lm Ra 80 IP44

R12716 branco

€ 78

± 70

● Ø70

● LED

● regulável

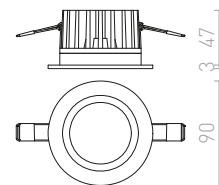

TOLEDO SQ

230 V LED 7 W $\angle 60^\circ$ 3000 K 513 lm Ra 80 IP44

R12717 branco

€ 78

± 70

● Ø70

● LED

● regulável

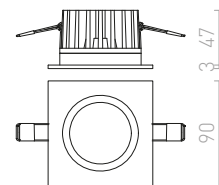



IP54

OWEN

Luminária embutida LED regulável com controlo de cor e intensidade de luz - DIMM TO WARM. Faixa de cores claras 3000K - 1800K. Instalação em teto em pladur. Adequado para ambientes húmidos. Regulação da intensidade da luz TRIAC.

OWEN DIMM EMBUTIDA

230V LED 7W $\angle 45^\circ$ 3000 K - 1800 K 520 lm Ra 90 IP54

R13667 branco

€ 78

R13668 preto

€ 78

↑ 110

● Ø55

● LED

● regulável



1800K → 3000K
DIMM TO WARM

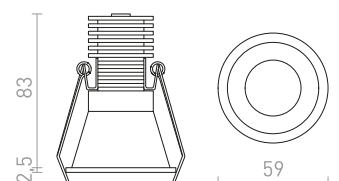





IP65



IP65



BELI

Luminária embutida sem moldura. Difusor de luz acrílico fosco levemente convexo. Adequada para áreas húmidas.

BELI R 10 EMBUTIDA

230 V LED 6 W 3000 K 520 lm Ra 80 IP65

R13430 acrílico fosco

€ 29

↑ 40
● Ø80

● LED

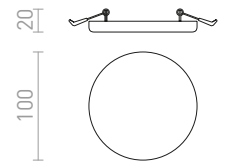

BELI R 21 EMBUTIDA

230 V LED 24 W 3000 K 2200 lm Ra 80 IP65

R13432 acrílico fosco

€ 68

↑ 40
● Ø195

● LED

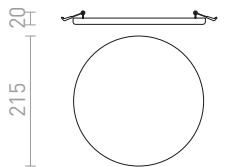

BELI

Luminária embutida sem moldura. Difusor de luz acrílico fosco levemente convexo. Adequada para áreas húmidas.

BELI SQ 10 EMBUTIDA

230 V LED 6 W 3000 K 645 lm Ra 80 IP65

R13521 acrílico fosco

€ 32

↑ 40
■ 80x80

● LED

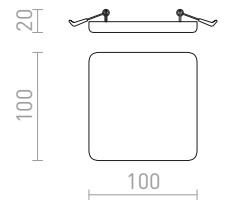

BELI SQ 21 EMBUTIDA

230 V LED 24 W 3000 K 2299 lm Ra 80 IP65

R13522 acrílico fosco

€ 78

↑ 40
■ 190x190

● LED

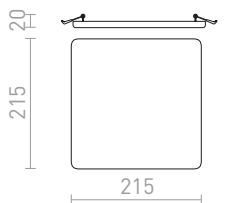



IP54



EQUA

Luminária redonda embutida de casa de banho para casquilho GU10. Apenas para tetos em gesso.

EQUA

230 V GU10 35 W IP54

R12746 cromo

€ 17 %

↑ 100
● Ø75



G11841

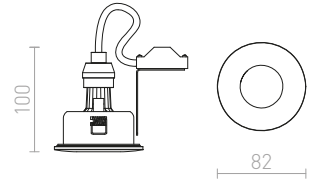

IP54



APRIORI

Luminária redonda embutida de casa de banho para casquilho GU10. Apenas para tetos em gesso.

APRIORI

230 V GU10 35 W IP54

R12747 branco/vidro acetinado

€ 24

↑ 140
● Ø75



G11841

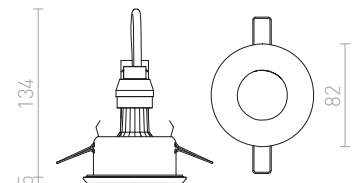

IP44



MAJESTIC

Luminária redonda embutida de casa de banho para casquilho GU10. Apenas para tetos em gesso.

MAJESTIC

230 V GU10 35 W IP44

R12911 alumínio escovado

€ 32 %

↑ 130
● Ø65



G11841

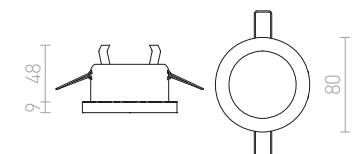



IP65



BERMUDA

Luminária redonda embutida de casa de banho para casquilho GU10. Apenas para tetos em gesso.

BERMUDA EMBUTIDA

230 V GU10 35 W IP65

R12749 branco

€ 22

R13604 preto

€ 22

↑ 150
● Ø75



G11841

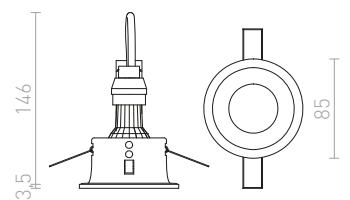



IP44



VERO

Foco embutido adequado para ambientes húmidos. A cobertura de vidro tem a parte central acetinada. Necessita de transformador apropriado (vendido separadamente).

VERO EMBUTIDA
12V GU5,3 50W IP44

R10395/12 cromo

€ 48

↑ 110
● Ø95

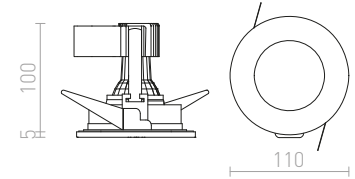

IP44



VERO

Foco embutido adequado para ambientes húmidos. A cobertura de vidro tem a parte central acetinada.

VERO EMBUTIDA
230V GU10 50W IP44

R10395 cromo

€ 58

↑ 110
● Ø95

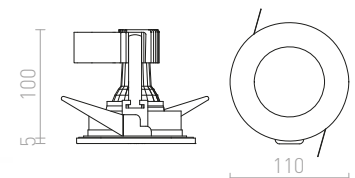



IP65



BELLA

Iluminação de banho de embutir para tetos falsos de gesso cartonado com reflector encastrado, para fontes de luz LED com casquilho GU10.

BELLA GU10 EMBUTIDA

230 V LED GU10 15 W IP65

R13598 branco

€ 24

R13599 preto

€ 24

R13600 cromo

€ 28

R13601 níquel mate

€ 28



↑ 140
● Ø68



G11841

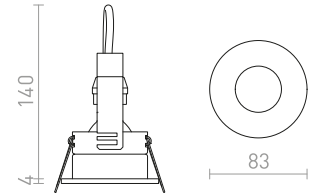

IP44

ACUA

Foco embutido adequado para ambientes húmidos. Cobertura de vidro acetinado.

ACUA EMBUTIDA

230 V GU10 50 W IP44

R10407 branco

€ 22



↑ 120
● Ø85



G11841

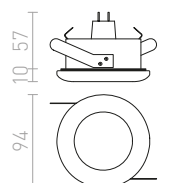



IP65

SPLASH

Luz metálica embutida adequada para ambientes húmidos. Disponível em cromo polido ou com acabamento de níquel cetim.

SPLASH R EMBUTIDA

230 V GU10 50 W IP65

R11733 cromo

€ 17.50

R11734 níquel mate

€ 16

120
Ø70



G11841

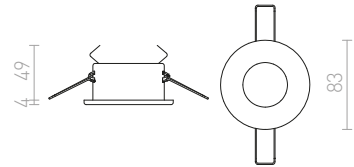

SPLASH SQ EMBUTIDA

230 V GU10 50 W IP65

R11735 cromo

€ 18.50

R11736 níquel mate

€ 18.50

120
Ø70



G11841

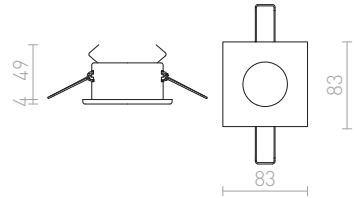

IP65





IP65



IP65



ASTOR

Luminária embutida com moldura em alumínio escovado. A cobertura em vidro tem a parte central acetinada. Adequada para ambientes húmidos.

ASTOR R

230 V GU10 50 W IP65

R10573 alumínio escovado

€ 25

↑ 100
● Ø60

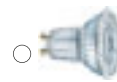

G11841

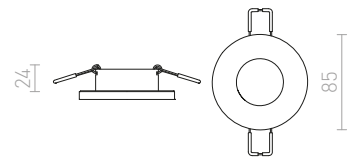

ASTOR SQ

230 V GU10 50 W IP65

R10574 alumínio escovado

€ 25

↑ 100
● Ø60



G11841

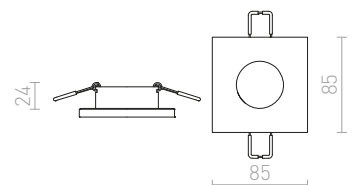



IP65



INCA

Luminária de casa de banho embutida com casquilho GU10 para fontes de luz LED. Apenas para paredes em gesso.

INCA R

230 V GU10 7 W IP65

R12657 branco

€ 32

↑ 150
● Ø70



G11841

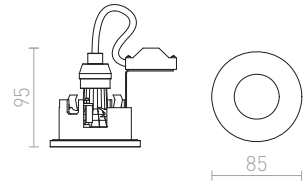

IP65



BRAN

Iluminação de casa de banho de embutir para tetos falsos em gesso cartonado, sem moldura, para fontes de luz LED com casquilho GU10.

BRAN EMBUTIDA

230 V LED GU10 15 W IP65

R13605 branco

€ 28

↑ 140
● Ø80



G11841

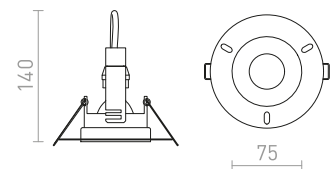

IP65



ISLA

Iluminação de embutir para tetos falsos em gesso cartonado, com reflector redondo, para fontes de luz LED com casquilho GU10.

ISLA EMBUTIDA

230 V LED GU10 15 W IP65

R13603 branco

€ 18

↑ 140
● Ø70



G11841

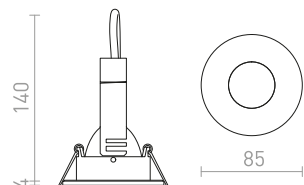



IP44

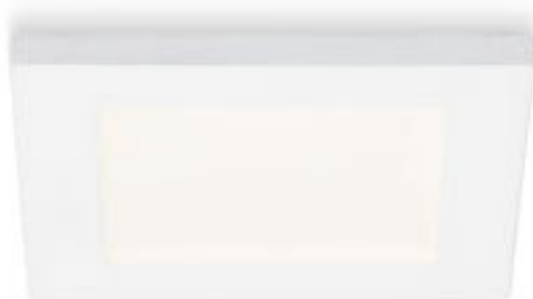

IP44



LEROY

Luminária de casa de banho embutida com casquilho GU5,3 para fontes de luz 12V. Apenas para paredes em gesso.

LEROY R

12 V GU5,3 35 W IP44

R12659 branco

€ 48

↑ 150
● Ø80

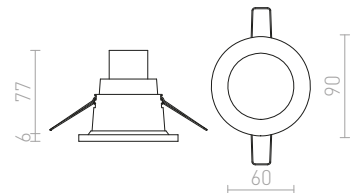
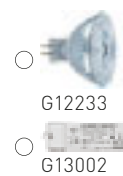

LEROY SQ

12 V GU5,3 35 W IP44

R12660 branco

€ 48

↑ 150
■ 76x76

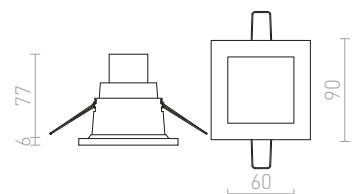



COIMBRA

Luminária LED circular embutida com LED, para ajuste de profundidade. Apenas para montagem em tetos de gesso.

COIMBRA EMBUTIDA

230 V LED 24 W 3000 K 1800 lm Ra 80

R12527 preto

€ 98 %



↑ 150
● Ø450

● LED

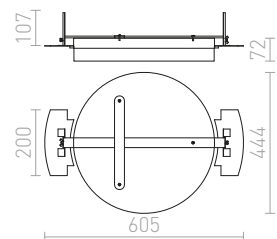



IPSO

Luz embutida sem moldura para fontes de luz com casquilho GU10.

IPSO R FIXO

230 V GU10 35 W

R13288 branco

€ 24

↑ 150
● Ø85



G11841

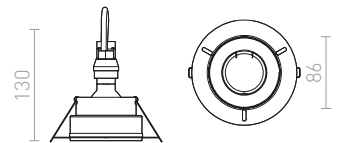

IPSO R FRAMELESS

230 V GU10 50 W

R12046 branco

€ 48

↑ 140
● Ø120



G11841

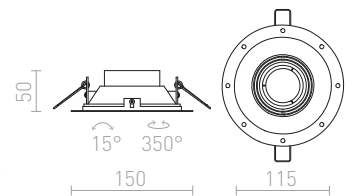

IPSO SQ FRAMELESS

230 V GU10 50 W

R12045 branco

€ 48

↑ 140
■ 120x120



G11841

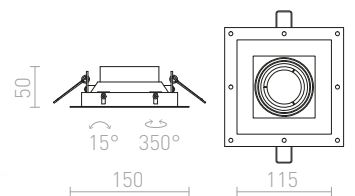



ELECTRA

Luminária embutida sem moldura com casquilho cardan para fontes de luz GU10.

ELECTRA I

230 V GU10 50 W

R12052 preto

€ 88

↑ 140
 108x108



G11841

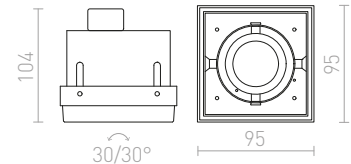

ELECTRA II

230 V GU10 2x50 W

R12053 preto

€ 138

↑ 140
 213x108



G11841

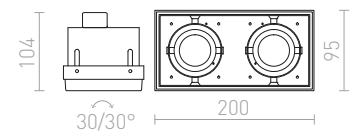



ELECTRA

Luminária embutida sem moldura com casquilho cardan para fontes de luz 12V G53. O transformador é vendido separadamente.

ELECTRA I

12 V G53 50 W

R12050 preto

€ 129

↑ 180

▣ 170x170



G13656



G13002

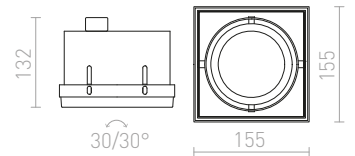

ELECTRA II

12 V G53 2x50 W

R12051 preto

€ 215

↑ 180

▣ 333x170



G13656



G13002

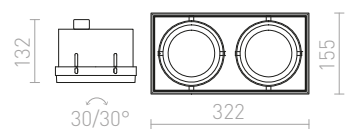



QUO

Luminária de gesso redonda sem moldura. A superfície pode ser pintada com tinta para interiores. Instalação apenas em paredes de gesso.

QUO R EMBUTIDA

230 V GU10 35 W

R12361 gesso

€ 22

↑ 150
 ↗ 80x80



G11841

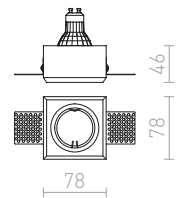

QUO R II EMBUTIDA

230 V GU10 2x35 W

R12900 gesso

€ 38

↑ 160
 ↗ 80x150



G11841

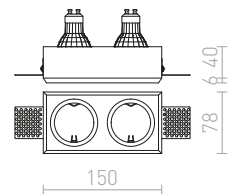

DAG

Luminária embutida em gesso sem moldura. Instalação apenas em paredes de gesso.

DAG R 83 EMBUTIDA

230 V GU10 35 W

R12357 gesso

€ 28

↑ 150
 ● Ø130

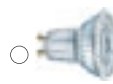

G11841

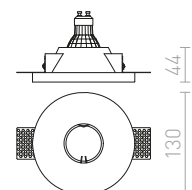



DANDY

Luminária de gesso embutida sem moldura para fontes de luz com casquilho GU10. Instalação apenas em paredes de gesso.

DANDY R EMBUTIDA

230 V GU10 35 W

R12362 gesso

€ 18.50



↑ 150
 ● Ø100

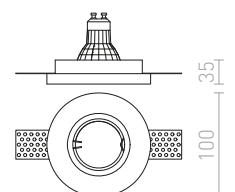



DAG

Luminária embutida em gesso sem moldura.
Instalação apenas em paredes de gesso.

DAG SQ EMBUTIDA

230 V GU10 35 W

R12355 gesso

€ 25

↑ 150
120x120



G11841

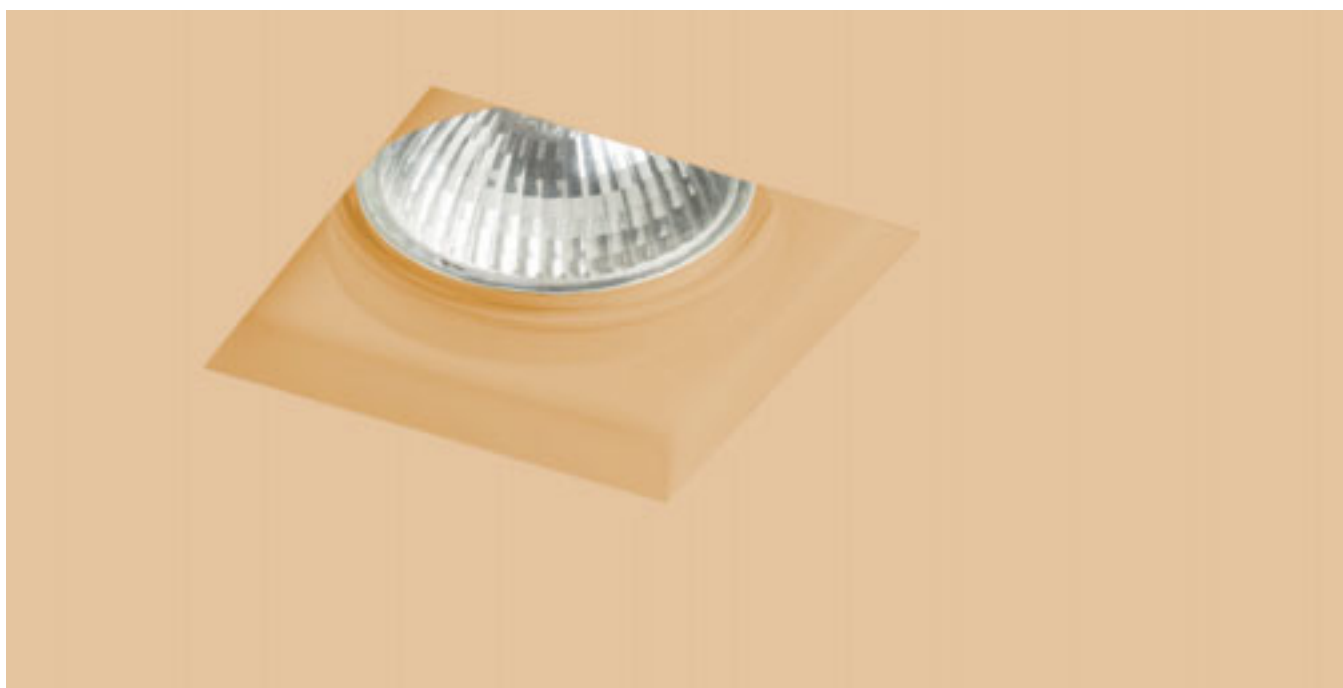
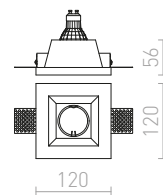

DANDY

Luminária de gesso embutida sem moldura para fontes de luz com casquilho GU10. Instalação apenas em paredes de gesso.

DANDY SQ EMBUTIDA

230 V GU10 35 W

R12363 gesso

€ 18.50

↑ 150
100x100



G11841

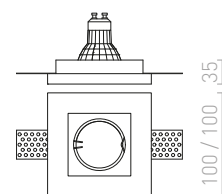



QUO

Luminária de gesso quadrada sem moldura.
A superfície pode ser pintada com tintas para interiores. Instalação apenas em paredes de gesso.

QUO SQ I EMBUTIDA

230 V GU10 35 W

R12360 gesso

€ 22

↑ 150
80x80



G11841

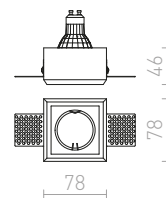

QUO SQ II EMBUTIDA

230 V GU10 2x35 W

R13126 gesso

€ 38

↑ 160
80x150



G11841

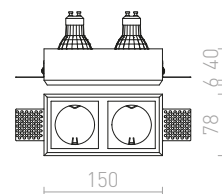





DAN SQ

Luminária de gesso embutida com cobertura de vidro acetinado. Instalação apenas em tetos de gesso.

DAN SQ 80 EMBUTIDA

230 V GU10 35 W

R12356 gesso

€ 26



↑ 150
 120x120

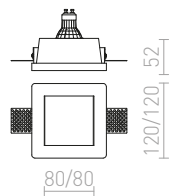

MIA

Luminária de gesso embutida com cobertura de policarbonato mate. Sem moldura. Instalação apenas em tetos de gesso cartonado.

MIA R EMBUTIDA

230 V E27 2x18 W

R10444 gesso/acrílico acetinado

€ 178



↑ 180
 Ø260

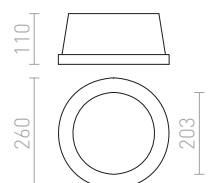





DINGO

Luminária embutida em gesso, sem moldura. Pode ser pintada com tintas para interiores. Instalação apenas em paredes de gesso.

DINGO S FIXO
230 V GU10 35 W

R12358 gesso

€ 24

↑ 150
120x120

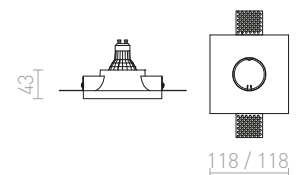

DINGO S DIRECIONAL
12 V GU5,3 50 W

R10271 gesso

€ 78

↑ 150
Ø157

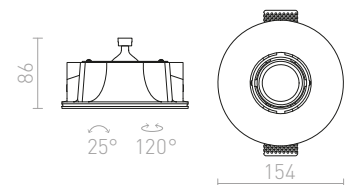

DINGO GU10 II DIRECIONAL
230 V GU10 2x35 W

R12037 gesso

€ 129

↑ 150
257x157

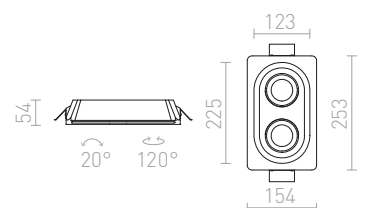



DINGO

Luminária de gesso embutida sem moldura e com abertura redonda. Pode ser pintada com tintas comuns. Apenas para instalação em paredes de gesso.

DINGO R DIRECIONAL

12V G53 50W

R10269 gesso

€ 120

↑ 150

● Ø232



G13656



G13002

96

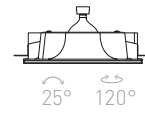

25° 120°

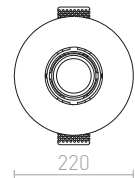

220



DINGO

Luminária de gesso embutida com abertura oval para duas fontes de luz. Sem moldura. Pode ser pintada com tintas para interiores. Apenas para instalação em paredes de gesso.

DINGO II DIRECIONAL

12V G53 2x50W

R10270 gesso

€ 138

↑ 150

■ 408x250



G13656



G13002

110

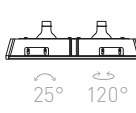

25° 120°

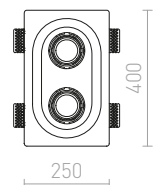

400

250







DINO SQUARE

Luminária embutida sem moldura em gesso com abertura quadrada. A superfície pode ser pintada com tintas para interiores. Instalação apenas em paredes de gesso.

DINO SQ G53 DIRECIONAL

12V G53 50 W

R10272 gesso

€ 58 %

↑ 150

↙ 252x252



G13656

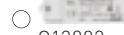

G13002

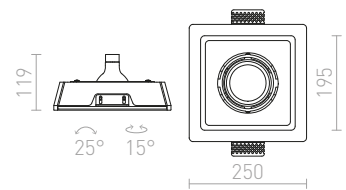

DINGO

Luminária de gesso embutida com foco inclinável, para fontes de luz G5.3. Instalação apenas em paredes de gesso.

DINGO TUB EMBUTIDA

12V GU5,3 35 W

R12359 gesso

€ 68

↑ 150

↙ 170x170



G12233



G13002

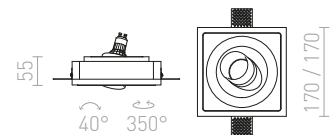

DINO SQUARE

Luminária embutida sem moldura em gesso com abertura quadrada. A superfície pode ser pintada com tintas para interiores. Instalação apenas em paredes de gesso.

DINO SQ GU10 DIRECIONAL

230 V GU10 35 W

R12038 gesso

€ 78

↑ 150

↙ 157x157



G11841

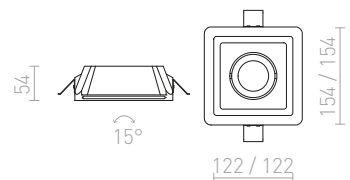







BIANCA

Luminária embutida em vidro acetinado ou opalino.

BIANCA SQ EMBUTIDA

230 V GU10 50 W

R10304 vidro colorido opala

€ 32 %

↑ 100
● Ø62



G11841

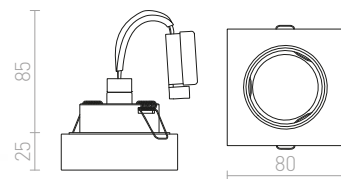

KAY

Luminária embutida com cobertura de vidro acetinado.

KAY R EMBUTIDA

230 V/350 mA LED 5 W 3000 K 450 lm Ra 80

R10419 vidro acetinado

€ 29 %

↑ 80
● Ø65

● LED

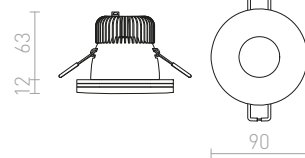

KAY SQ EMBUTIDA

230 V/350 mA LED 5 W 3000 K 450 lm Ra 80

R10418 vidro acetinado

€ 32 %

↑ 80
● Ø65

● LED

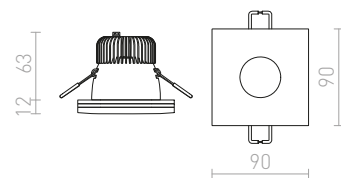





ERGO

Foco decorativo embutido com LED integrado. Inclui o driver.

ERGO EMBUTIDA

230 V LED 5 W 3000 K 350 lm Ra 80

R10561 cromo

€ 24 %

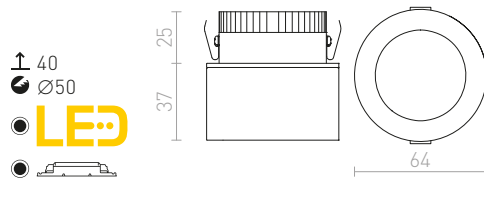

SPARKLE

Luminária embutida redonda inclinável com LED integrado. Apenas para paredes de gesso.

SPARKLE EMBUTIDA

230 V LED 5 W $\angle 24^\circ$ 3000 K 400 lm Ra 80

R12861 alumínio polido

€ 24 ➤

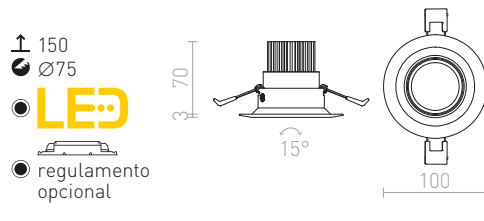

REWA

Luminária embutida com moldura maciça texturada.

REWA FIXA

230 V GU10 50 W

R10421 cromo

€ 22 ➤

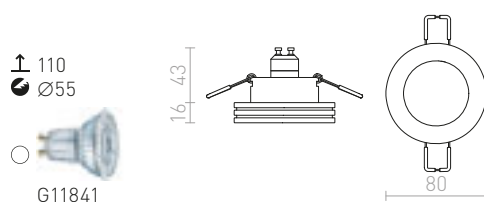



TOMBOY

Foco LED de alta potência inclinável. Apenas em tetos de gesso.

TOMBOY

230 V LED 25 W $\angle 38^\circ$ 3000 K 1920 lm Ra 80

R12662 branco/preto

€ 98 %

↑ 180
157x157

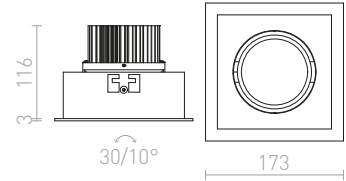
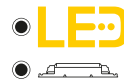

KELLY LED

Luz embutida com uma fonte de luz LED fixa integrada. Somente para instalação em parede de gesso cartonado. Regulação da intensidade da luz TRIAC.

KELLY LED DIMM EMBUTIDA

230 V LED 15 W $\angle 45^\circ$ 3000 K 750 lm Ra 80

R12635 branco

€ 98

R12636 preto

€ 120

↑ 60
Ø120

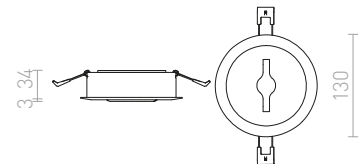

KELLY LED

Luz regulável semi-embutida com LED integrado e um foco direcional. Somente para instalação em teto de gesso cartonado. Regulação da intensidade da luz TRIAC.

KELLY LED DIMM SEMI EMBUTIDA

230 V LED 12 W $\angle 24^\circ$ 3000 K 600 lm Ra 80

R12637 branco

€ 120

R12638 preto

€ 120

↑ 50
Ø65

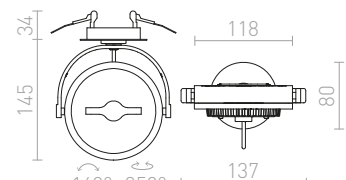





ZIZI

Luminária embutida em alumínio lacado de branco, inclinável, para fontes de luz AR111.

ZIZI I EMBUTIDA

12V G53 50 W

R12695 branco

€ 48 %

↑ 160

● Ø160



G13656



G13002

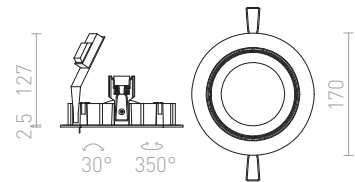

ZIZI II EMBUTIDA

12V G53 50 W

R12696 branco

€ 88 %

↑ 160

■ 320x160



G13656

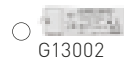

G13002

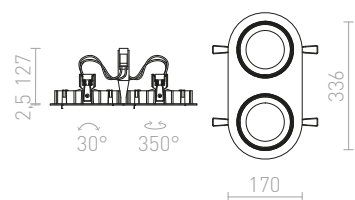



PASADENA

Luminária de alumínio embutida inclinável.
Disponível em versão natural ou duas versões lacadas.
Para fontes de luz AR111.

PASADENA G53 R I

12 V G53 50 W

R12697 branco

€ 68

R12699 preto

€ 58 %

↑ 140

⊗ Ø145



G13656



G13002

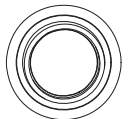
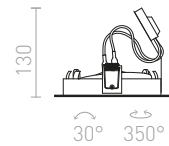

168



GRANADA

Foco embutido em alumínio lacado maciço com inclinação, para fontes de luz AR111.

GRANADA R

12 V G53 50 W

R12706 branco

€ 48 %

↑ 160

⊗ Ø170



G13656



G13002

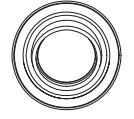
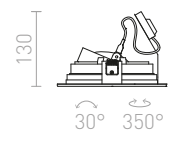

186





GRANADA

Foco embutido em alumínio lacado maciço com inclinação, para fontes de luz AR111.

GRANADA SQ

12 V G53 50 W

R12707 branco

€ 35 %

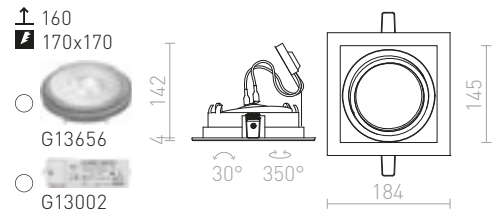

PASADENA

Luminária embutida para fontes de luz AR111 com opção de inclinação.

PASADENA G53 SQ I

12 V G53 50 W

R12700 branco

€ 68

R12702 preto

€ 48 %

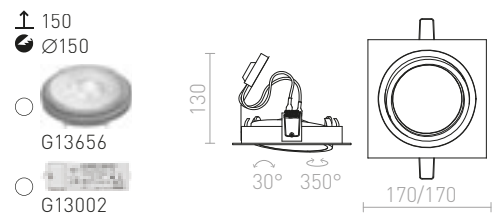

PASADENA G53 SQ II

12 V G53 2x50 W

R12703 branco

€ 120

R12704 alumínio escovado

€ 120

R12705 preto

€ 88 %

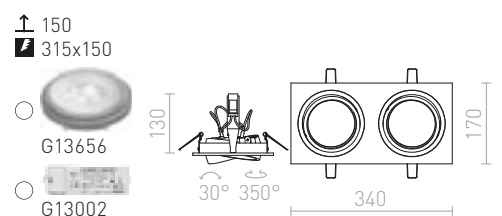



LIZARD

Luminária pequena embutida com LED integrado, apenas para tetos em gesso.

LIZARD I EMBUTIDA

230 V LED 2 W $\angle 24^\circ$ 3000 K 128 lm Ra 80

R12854 branco

€ 18.50

↑ 150
 ▣ 35x35

● LED

● regulamento opcional

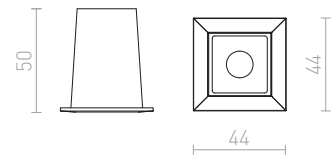

BONDY

Luminária embutida de LED para tetos de gesso.

BONDY I EMBUTIDA

230 V LED 7 W $\angle 24^\circ$ 3000 K 560 lm Ra 80

R12856 branco

€ 68

↑ 100
 ▣ 90x90

● LED

● regulamento opcional

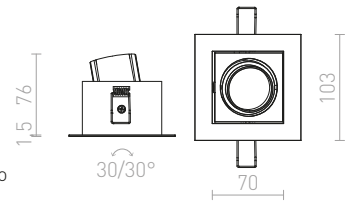

BONDY II EMBUTIDA

230 V LED 2x7 W $\angle 24^\circ$ 3000 K 1120 lm Ra 80

R12857 branco

€ 98

↑ 100
 ▣ 170x90

● LED

● regulamento opcional

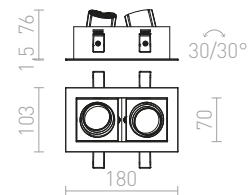

BONDY III EMBUTIDA

230 V LED 3x7 W $\angle 24^\circ$ 3000 K 1680 lm Ra 80

R12858 branco

€ 98

↑ 100
 ▣ 243x90

● LED

● regulamento opcional

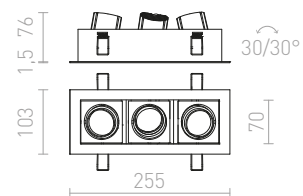





FIZZ

Luminária embutida com moldura de alumínio e casquilhos cardan, para fontes de luz inclináveis em todas as direções. Apenas para paredes de gesso.

FIZZ III DIRECIONAL

12V GU5,3 3x50 W

R10148 alumínio

€ 58 %

↑ 95
 241x88



G12233



G13002

83

45/30°

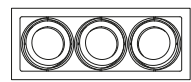

250

100

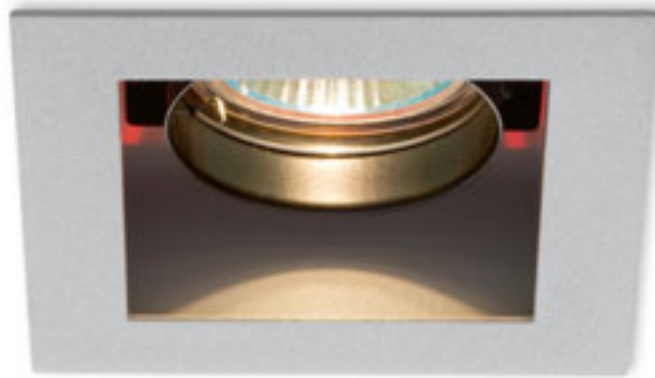

MONE

Luminária com foco inclinável num eixo. Moldura de alumínio lacado. Apenas para paredes de gesso.

MONE I DIRECIONAL

12 V GU5,3 50 W

R10204 branco

€ 22 %

R10216 cinzento prata

€ 22 %

↑ 140

▣ 83x85



G12233



G13002

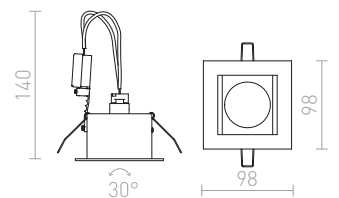

MONE II DIRECIONAL

12 V GU5,3 2x50 W

R10217 cinzento prata

€ 28 %

↑ 140

▣ 145x85



G12233



G13002

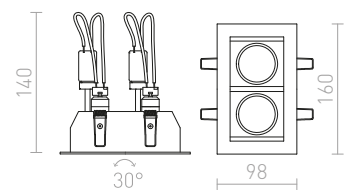

MONE III DIRECIONAL

12 V GU5,3 3x50 W

R10218 cinzento prata

€ 29 %

↑ 140

▣ 215x85



G12233



G13002

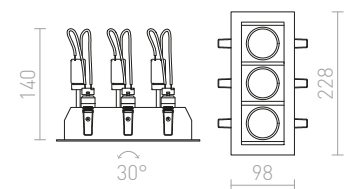



PASADENA

Luminária de alumínio embutida inclinável.
Disponível em versão natural ou duas versões lacadas.
Para fontes de luz GU10.

PASADENA GU10 R EMBUTIDA

230 V GU10 50 W

R12708 alumínio escovado

€ 19 %

↑ 140
● Ø80



G11841

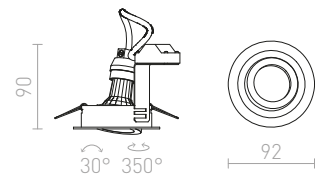



MURO

Foco quadrado embutido angular com inclinação para fontes de luz GU10. Apenas para paredes em gesso.

MURO SQ EMBUTIDA

230 V GU10 50 W

R12748 níquel mate

€ 12.50

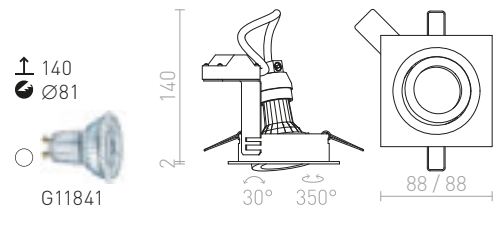

PASADENA

Luminária de alumínio embutida inclinável. Disponível em versão natural ou duas versões lacadas. Para fontes de luz GU10.

PASADENA GU10 SQ I EMBUTIDA

230 V GU10 50 W

R12709 alumínio escovado

€ 22

R12710 branco

€ 22

R12711 preto

€ 22

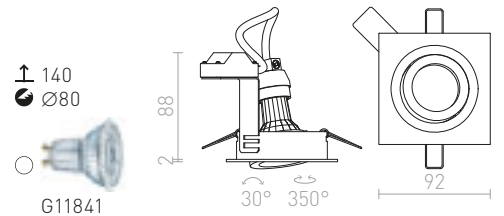

PASADENA GU10 SQ II EMBUTIDA

230 V GU10 2x50 W

R12712 alumínio escovado

€ 29

R12713 branco

€ 48

R12714 preto

€ 48

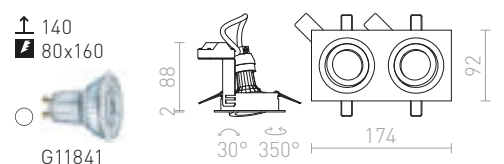





LOOKER

Foco embutido redondo com LED integrado e reentrância profunda.

LOOKER 17 EMBUTIDA

230 V LED 30 W $\angle 35^\circ$ 3000 K 2400 lm Ra 80

R12865 branco

€ 78

- ↑ 150
- Ø150
- **LED**
- regulamento opcional

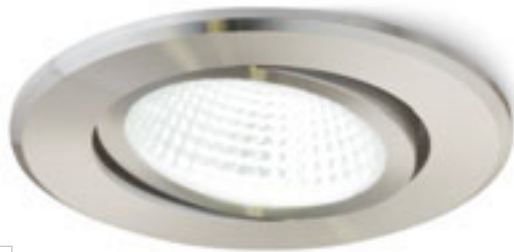
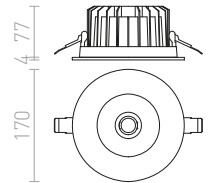

MIRO

Foco embutido inclinável com LED integrado. Driver incluído.

MIRO EMBUTIDA

230 V/350 mA LED 3 W 3000 K 270 lm Ra 80

R10420 aço inoxidável

€ 25

- ↑ 60
- Ø70
- **LED**
- regulamento opcional

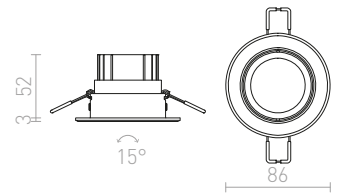

SPRAY

Luminária embutida com uma fonte de luz LED fixa, apenas para instalação em paredes de gesso.

SPRAY 11 EMBUTIDA

230 V LED 9 W $\angle 24^\circ$ 3000 K 1250 lm Ra 90

R13302 preto

€ 22

- ↑ 60
- Ø95
- **LED**
- regulamento opcional

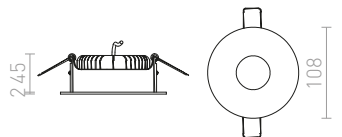

SPRAY 9 EMBUTIDA

230 V LED 7 W $\angle 24^\circ$ 3000 K 880 lm Ra 90

R13300 preto

€ 18.50

- ↑ 60
- Ø80
- **LED**
- regulamento opcional

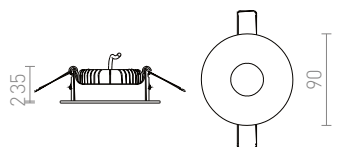



TOPIC

Foco embutido metálico inclinável em cromo, níquel mate ou acabamento lacado em branco.

TOPIC R DIRECIONAL

230 V GU10 50 W

R11731 níquel mate

€ 8.50 %

R11742 cromo

€ 6.50 %

R11743 mate branco

€ 11

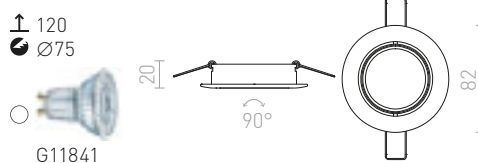

VIP

Foco giratório de metal em design circular.

VIP DOBRAR

230 V GU10 50 W

R11746 mate branco

€ 18.50

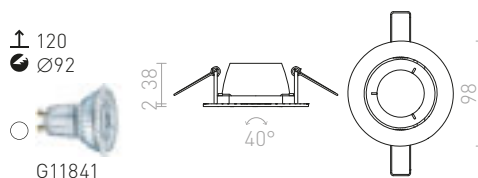

SOBER

Foco circular ligeiramente inclinável de metal lacado branco, com lâmpada embutida.

SOBER EMBUTIDA

230 V GU10 50 W

R11738 branco

€ 24

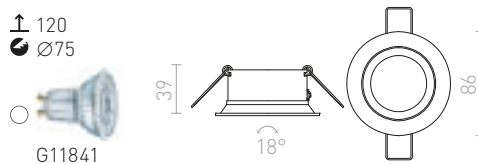







TECH I

Foco embutido fixo com LED integrado, revestido com vidro transparente.

TECH I FIXA

230 V LED 5,4 W $\angle 40^\circ$ 3000 K 340 lm Ra 80

R10404 branco

€ 35

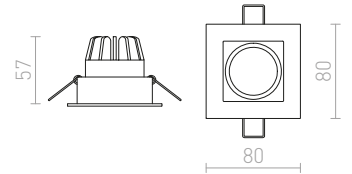
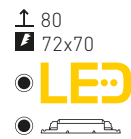

LEDA

Foco embutido com montagem em cardan de fonte de luz LED.

LEDA EMBUTIDA

230 V/350 mA LED 5,4 W $\angle 25^\circ$ 3000 K 340 lm Ra 80

R10402 branco

€ 48

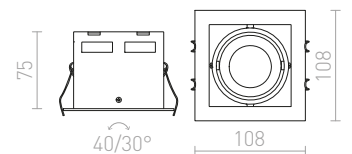
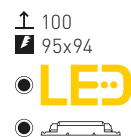

TIM

Foco embutido inclinável com LED integrado. Driver incluído.

TIM EMBUTIDA

230 V LED 10 W 3000 K 750 lm Ra 80

R12009 branco

€ 88

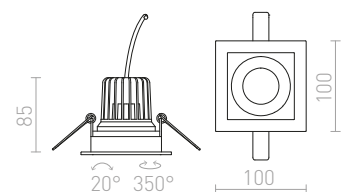
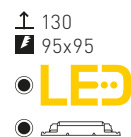



TOPIC

Foco embutido metálico inclinável em cromo, níquel mate ou acabamento lacado em branco.

TOPIC SQ DIRECIONAL

230 V GU10 50 W

R11732 níquel mate

€ 7 %

R11744 cromo

€ 6 %

R11745 mate branco

€ 8.25

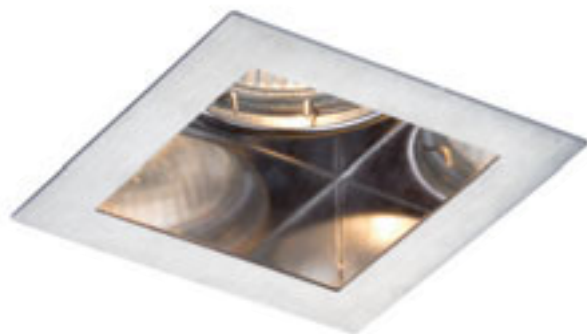
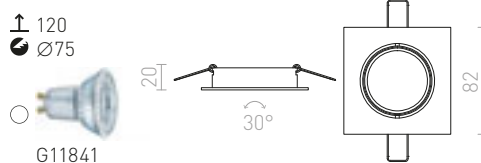

MERIKO

Foco redondo embutido inclinável para uma fonte de luz GU10. Apenas para uso em paredes de gesso.

MERIKO GU10 FIXO

230 V GU10 50 W

R10219 aço inoxidável

€ 24 %

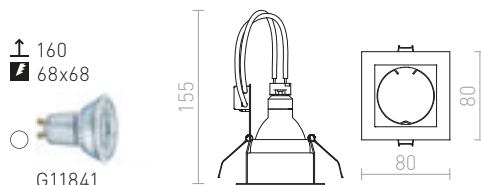

ZURI

Foco embutido quadrado com um casquilho fixo GU10.

ZURI SQ EMBUTIDA

230 V GU10 35 W

R13390 branco

€ 10.50 %

R13391 preto

€ 10.50 %

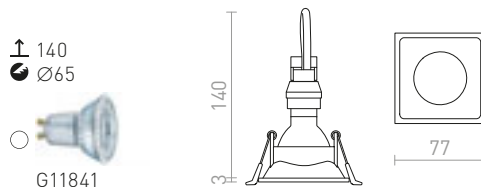



ACASA

Foco redondo embutido inclinável para casquilho GU10. Apenas para uso em paredes de gesso.

ACASA EMBUTIDA

230 V GU10 50 W

R12750 branco

€ 25

↑ 140
 90x90



G11841

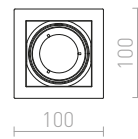
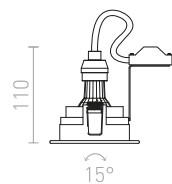

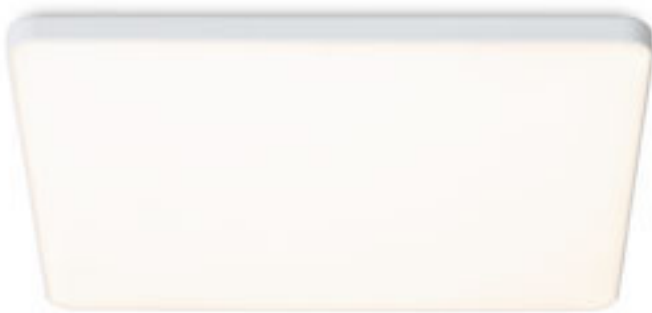

BJORK

Iluminação LED embutida para teto de gesso cartonado de baixa profundidade embutida e moldura. Adequada para combinação com a gama de luminárias de montagem saliente Larisa. O tamanho do furo de montagem pode ser selecionado usando as molas de fixação deslizantes. As luminárias podem ser substituídas por luminárias de halógeno existentes, sem a necessidade de modificar os orifícios de montagem.

BJORK SQ 9 EMBUTIDA

230 V LED 6 W 3000 K 640 lm Ra 80

R13588 branco

€ 28

R13589 preto

€ 28

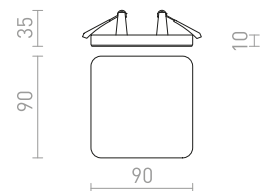

BJORK SQ 20 EMBUTIDA

230 V LED 18 W 3000 K 1800 lm Ra 80

R13590 branco

€ 68

R13591 preto

€ 68

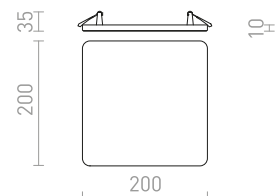
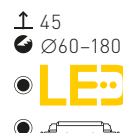



BJORK

Iluminação LED embutida para teto de gesso cartonado de baixa profundidade embutida e moldura. Adequada para combinação com a gama de luminárias de montagem saliente Larisa. O tamanho do furo de montagem pode ser selecionado usando as molas de fixação deslizantes. As luminárias podem ser substituídas por luminárias de halogéneo existentes, sem a necessidade de modificar os orifícios de montagem.

BJORK R 9 EMBUTIDA

230 V LED 6 W 3000 K 570 lm Ra 80

R13582 branco

€ 26

R13583 preto

€ 26

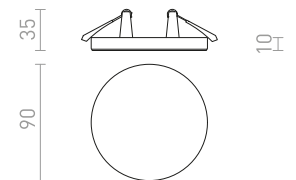
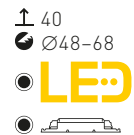

BJORK R 16 EMBUTIDA

230 V LED 12 W 3000 K 1200 lm Ra 80

R13584 branco

€ 48

R13585 preto

€ 48

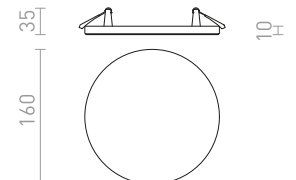
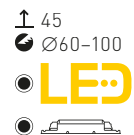

BJORK R 20 EMBUTIDA

230 V LED 18 W 3000 K 1800 lm Ra 80

R13586 branco

€ 58

R13587 preto

€ 58

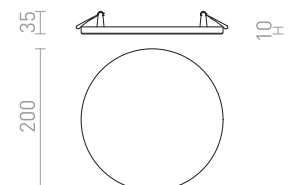
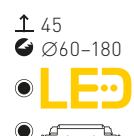



DADA

Luminária LED circular embutida para tetos em gesso com moldura arredondada e baixa profundidade na reentrância. Apenas para paredes de gesso.

DADA 9 EMBUTIDA

230 V LED 3W 3000 K 180 lm Ra 80

R12870 cromo preto

€ 10.50

%

↑ 60
● Ø75

● LED

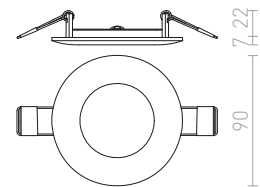
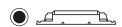

DADA 12 EMBUTIDA

230 V LED 6W 3000 K 360 lm Ra 80

R12871 branco

€ 15

%

R12872 cromo

€ 17

%

R12874 cobre

€ 22

→

R12875 cromo preto

€ 22

→

↑ 60
● Ø110

● LED

● regulamento
opcional

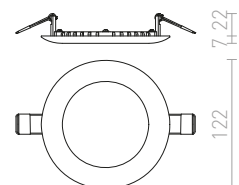



DADA

Luminária LED circular embutida para tetos em gesso com moldura arredondada e baixa profundidade na reentrância. Apenas para paredes de gesso.

DADA 17 EMBUTIDA

230 V LED 12 W 3000 K 720 lm Ra 80

R12876	branco	€ 22	%
R12877	chromo	€ 29	➔
R12880	chromo preto	€ 24	%

- ↑ 60
- ⊗ Ø160
- LED
- regulamento opcional

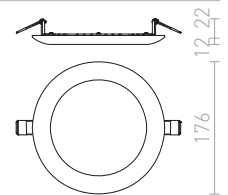

DADA 23 EMBUTIDA

230 V LED 18 W 3000 K 1080 lm Ra 80

R12881	branco	€ 32	%
R12882	chromo	€ 24	%
R12884	cobre	€ 32	%
R12885	chromo preto	€ 35	%

- ↑ 100
- ⊗ Ø210
- LED
- regulamento opcional

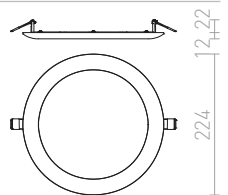

DADA 30 EMBUTIDA

230 V LED 24 W 3000 K 1440 lm Ra 80

R12886	branco	€ 48	%
R12887	chromo	€ 48	%
R12888	ouro	€ 58	➔
R12889	cobre	€ 48	%
R12890	chromo preto	€ 48	%

- ↑ 100
- ⊗ Ø280
- LED
- regulamento opcional

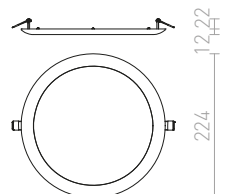



HUE

Luminária muito fina embutida, para LEDs de alta luminosidade. A moldura está disponível em cromo, cromo preto, níquel mate, laca branca e imitação de madeira.

HUE R 9 EMBUTIDA

230 V LED 6 W 3000 K 540 lm Ra 80

R12760	branco	€ 22
R12761	cromo preto	€ 17.50 %
R12762	cromo	€ 22 →
R12763	níquel mate	€ 22 %
R12764	faia decorativa	€ 24

↑ 60

● Ø70

● LED

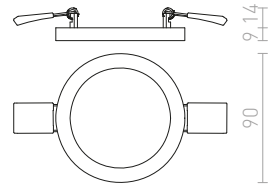

HUE R 17 EMBUTIDA

230 V LED 18 W 3000 K 1620 lm Ra 80

R12765	branco	€ 48
R12766	cromo preto	€ 38 %
R12767	cromo	€ 48 →
R12768	níquel mate	€ 38 %
R13401	imitação de imbuia escura	€ 48 %

↑ 60

● Ø155

● LED

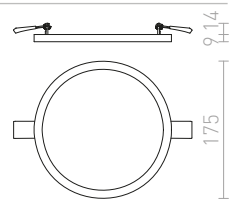

HUE R 22 EMBUTIDA

230 V LED 24 W 3000 K 2160 lm Ra 80

R12770	branco	€ 68
R12771	cromo preto	€ 48 %
R12772	cromo	€ 48 %
R12773	níquel mate	€ 48 %
R12774	faia decorativa	€ 68 →
R13402	imitação de imbuia escura	€ 58 %

↑ 60

● Ø205

● LED

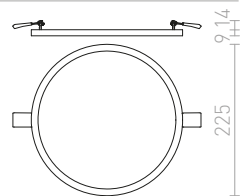







HUE

Luminária muito fina embutida para LEDs de alta luminosidade. A moldura está disponível em cromo, cromo preto, níquel mate, laca branca e imitação de madeira. Regulação da intensidade da luz TRIAC.

HUE R 9 DIMM EMBUTIDA

230 V LED 6 W 3000 K 540 lm

R13127 branco	€ 58
R13128 cromo preto	€ 48
R13129 cromo	€ 58
R13130 níquel mate	€ 48
R13131 faixa decorativa	€ 58

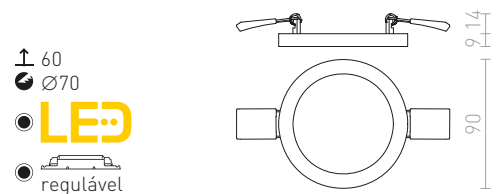

HUE R 17 DIMM EMBUTIDA

230 V LED 18 W 3000 K 1620 lm Ra 80

R13053 branco	€ 120
R13054 cromo preto	€ 88
R13055 cromo	€ 98
R13056 níquel mate	€ 98
R13441 imitação de imbuia escura	€ 98

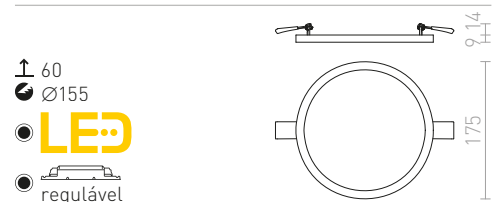

HUE R 22 DIMM EMBUTIDA

230 V LED 24 W 3000 K 2160 lm Ra 80

R13058 branco	€ 120
R13059 cromo preto	€ 120
R13060 cromo	€ 120
R13061 níquel mate	€ 120
R13062 faixa decorativa	€ 120
R13442 imitação de imbuia escura	€ 120

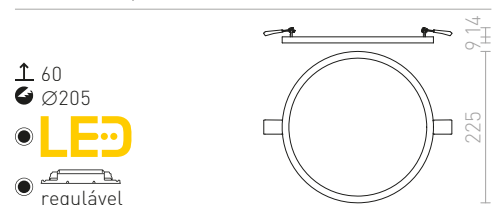

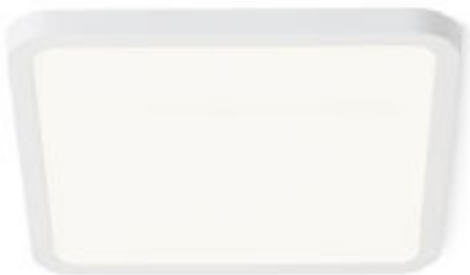

HUE

Luminária muito fina embutida, para LEDs de alta luminosidade. A moldura está disponível em cromo, cromo preto, níquel mate, laca branca e imitação de madeira.

HUE SQ 9 EMBUTIDA

230 V LED 6 W 3000 K 540 lm Ra 80

R12775	branco	€ 18.50	
R12776	cromo preto	€ 18	%
R12777	cromo	€ 22	%
R12778	níquel mate	€ 18	%

± 60
70x70

LED

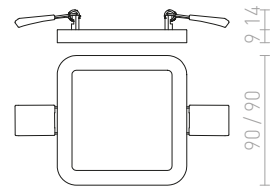

HUE SQ 17 EMBUTIDA

230 V LED 18 W 3000 K 1620 lm Ra 80

R12780	branco	€ 48	%
R12781	cromo preto	€ 35	%
R12782	cromo	€ 35	%
R12783	níquel mate	€ 38	%
R12784	faixa decorativa	€ 48	%

± 60
155x155

LED

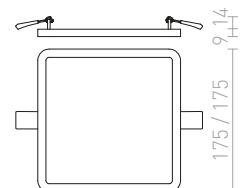
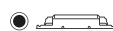

HUE SQ 22 EMBUTIDA

230 V LED 24 W 3000 K 2160 lm Ra 80

R12785	branco	€ 58	%
R12786	cromo preto	€ 48	%
R12787	cromo	€ 58	%
R12788	níquel mate	€ 58	%
R12789	faixa decorativa	€ 58	%

± 60
205x205

LED

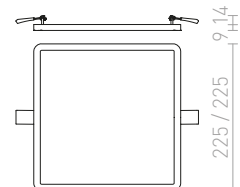







HUE

Luminária muito fina embutida para LEDs de alta luminosidade. A moldura está disponível em cromo, cromo preto, níquel mate, laca branca e imitação de madeira. Regulação da intensidade da luz TRIAC.

HUE SQ 9 DIMM EMBUTIDA

230 V LED 6 W 3000 K 540 lm Ra 80

R13132 branco	€ 58
R13133 cromo preto	€ 48
R13134 cromo	€ 58
R13135 níquel mate	€ 48

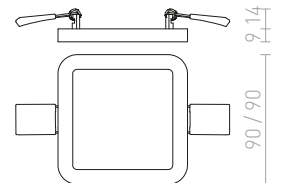
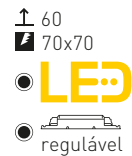

HUE SQ 17 DIMM EMBUTIDA

230 V LED 18 W 3000 K 1620 lm Ra 80

R13063 branco	€ 98
R13064 cromo preto	€ 98
R13065 cromo	€ 98
R13066 níquel mate	€ 98
R13067 faixa decorativa	€ 98

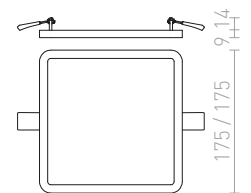
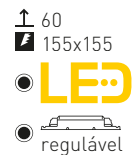

HUE SQ 22 DIMM EMBUTIDA

230 V LED 24 W 3000 K 2160 lm Ra 80

R13068 branco	€ 120
R13069 cromo preto	€ 120
R13070 cromo	€ 120
R13071 níquel mate	€ 120
R13072 faixa decorativa	€ 120

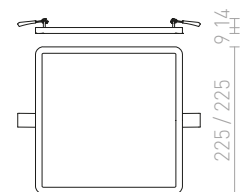
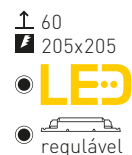



SOCORRO

Luminária muito fina com LED de alta potência integrado e uma moldura lacada em branco de alumínio fundido. Driver incluído.

SOCORRO SQ 85 EMBUTIDA

230 V LED 3 W 3000 K 240 lm Ra 80

R12967 branco

€ 11 →



↑ 60
75x75

● LED

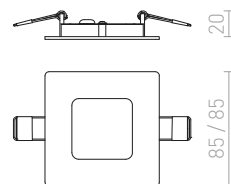

SOCORRO

Luminária muito fina com LED de alta potência integrado e uma moldura lacada em branco de alumínio fundido. Driver incluído.

SOCORRO R 85 EMBUTIDA

230 V LED 3 W 3000 K 240 lm Ra 80

R12963 branco

€ 12 →

↑ 60
Ø75

● LED

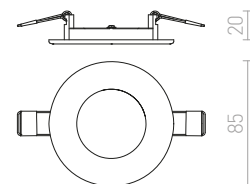

SOCORRO R 225 EMBUTIDA

230 V LED 18 W 3000 K 1440 lm Ra 80

R12965 branco

€ 35 →

↑ 60
Ø210

● LED

● regulamento
opcional

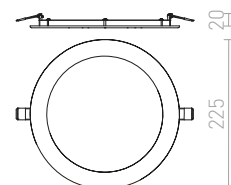







STRUCTURAL

Luminária embutida com LED e moldura lacada. Inclui o driver.

STRUCTURAL LED 40x40 EMBUTIDA

230V LED 40W 3000K 2918lm Ra80

R12062 branco

€ 198

- ↑ 60
- ▣ 395x395
- **LED**
- regulamento opcional

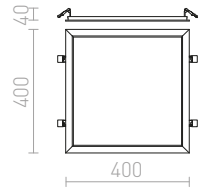

SLENDER

Luminária embutida muito fina com LED de alta potência integrado. Driver incluído.

SLENDER SQ 8 EMBUTIDA

230V LED 3W 3000K 300lm Ra80

R12186 cromo preto

€ 6.80

R12187 cromo

€ 7

R12188 níquel mate

€ 6.50

- ↑ 50
- ▣ 65x65
- **LED**
- regulamento

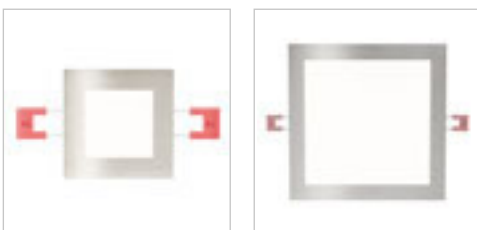
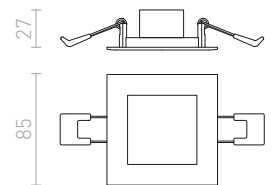

SLENDER SQ 22 EMBUTIDA

230V LED 18W 3000K 1800lm Ra80

R12126 cromo preto

€ 17.50

R12127 cromo

€ 16

- ↑ 30
- ▣ 210x210
- **LED**
- regulamento

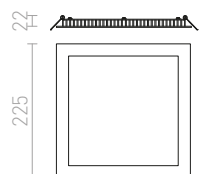



PESANTE

Luminária de LED linear para tetos de gesso.
Adequada para interiores modernos.

PESANTE 90 EMBUTIDA

230 V LED 40 W 3000 K 4200 lm Ra 80

R12722 branco

€ 220

↑ 80

■ 1200x76

● LED

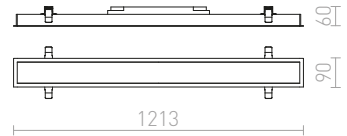
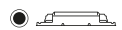

1213

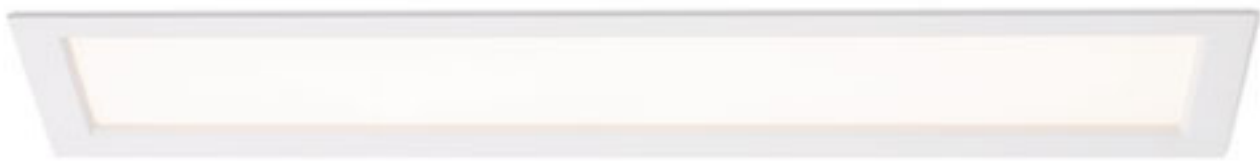

STRUCTURAL

Luminária embutida com LED e moldura lacada. Inclui o driver.

STRUCTURAL LED 60x15 EMBUTIDA

230 V LED 22 W 3000 K 1370 lm Ra 80

R12061 branco

€ 178

↑ 60

■ 582x131

● LED



● regulamento
opcional



600







IRIA

Aplique LED embutido com uma ranhura estreita para o feixe de luz.

IRIA R EMBUTIDA

230 V LED 3 W $\angle 10^\circ$ 3000 K 390 lm Ra80

R12611 branco

€ 58

↑ 120
⚡ Ø45



● LED

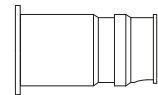

87

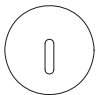

55

IRIA SQ EMBUTIDA

230 V LED 3 W $\angle 10^\circ$ 3000 K 390 lm Ra80

R12612 branco

€ 58

↑ 120
⚡ Ø45



● LED

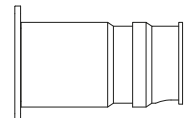

3 84

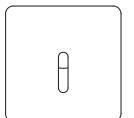

60



IP54

SEGNO

Aplique LED embutido para exterior com boa radiação emitida através de fenda estreita.

SEGNO EMBUTIDA

230 V LED 3 W 3000 K Ra80 IP54

R13566 branco

€ 98

R13567 cinzento antracite

€ 98

↑ 70
⚡ 172x62



● LED

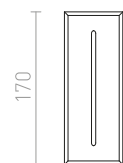

170

65

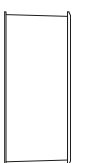

70 3



IP54



IP54

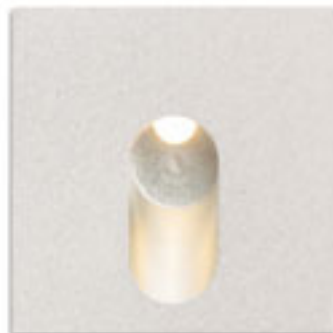

ELICA

Aplique LED embutido para exteriores com placa frontal de metal, para iluminação descendente. Caixa de montagem incluída.

ELICA R EMBUTIDA

230 V LED 3 W 3000 K 75 lm Ra 80 IP54

R12528 alumínio escovado

€ 68 %

± 95
Ø75

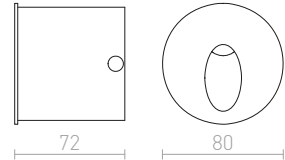

ELICA SQ EXTERIOR

230 V LED 3 W 3000 K 180 lm Ra 80 IP54

R10639 níquel mate

€ 35 %

R12529 alumínio escovado

€ 68 %

± 70
Ø75

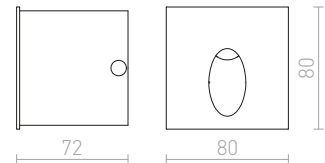

MEMPHIS

Aplique LED adequado como luz de orientação para corredores e escadas.

MEMPHIS R EMBUTIDO NA PAREDE

230 V LED 3 W ∠60° 3000 K 270 lm Ra 80

R12687 cinzento prata

€ 35

± 90
Ø45

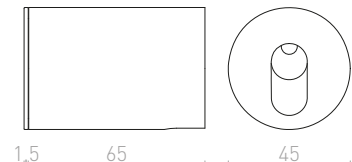

MEMPHIS SQ EMBUTIDO NA PAREDE

230 V LED 3 W ∠60° 3000 K 270 lm Ra 80

R12688 cinzento prata

€ 35

± 90
Ø40

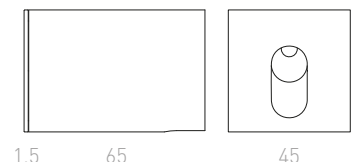







RIO

Luminária embutida de LED para instalação em paredes ocas ou nichos.

RIO R EMBUTIDA

230 V LED 3 W $\angle 22^\circ$ 3000 K 70 lm Ra 80

R12656 branco

€ 22

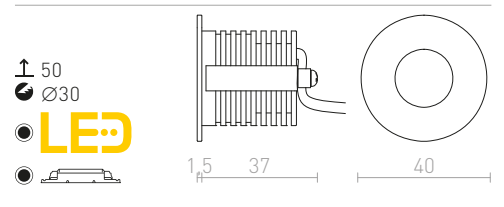

RIO SQ EMBUTIDA

230 V LED 3 W $\angle 22^\circ$ 3000 K 70 lm Ra 80

R12350 branco

€ 22

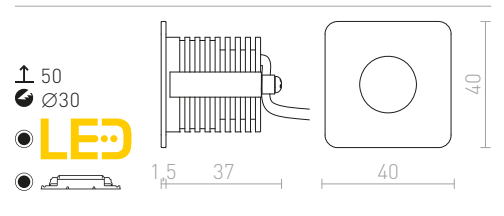

RIO SQ O EMBUTIDA

230 V LED 3 W $\angle 22^\circ$ 3000 K 70 lm Ra 80

R12655 branco

€ 22

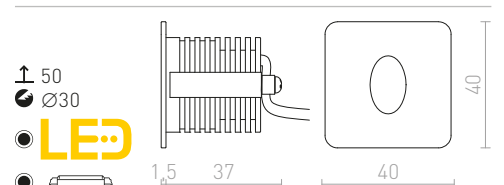



IP54



MARCO LED

Aplique redondo embutido, adequado para uso interior e exterior. Instale somente para iluminação descendente. Caixa de montagem incluída.

MARCO EMBUTIDA

230 V LED 3 W 3000 K 80 lm Ra 80 IP54

R12024 branco € 48

R12029 cinzento prata € 48

R12030 cinzento antracite € 48

↑ 60
● Ø76



● LED

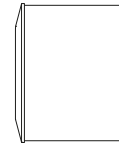

56

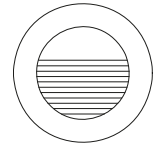

78



IP54

IP54



CLUB

Aplique LED adequado como luz de orientação para corredores e escadas.

CLUB EMBUTIDA

230 V LED 3 W 3000 K 270 lm Ra 80 IP54

R12685 cinzento prata € 58

↑ 90
● Ø57

● LED

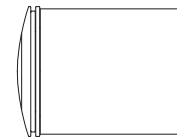

10

65

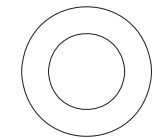

58

CLUB IND EMBUTIDA

230 V LED 3 W 3000 K 270 lm Ra 80 IP54

R12686 cinzento prata € 48

↑ 90
● Ø56



● LED

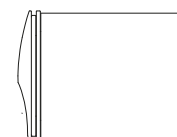

10

65

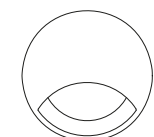

58



IP54



ASTERIA

Aplique embutido para uso externo. O quadro visível tem uma profundidade de 3 cm. Instale apenas para iluminação descendente.

ASTERIA EMBUTIDA

230 V LED 3 W 3000 K 180 lm Ra 80 IP54

R10558 cinzento prata

€ 68 %

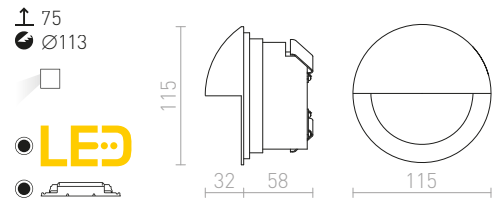





IP54



IP54



IP54



KICK

Luminária de orientação embutida com LED integrado que emite luz para um, dois ou três lados. Destina-se a instalações de parede.

KICK I EMBUTIDA

230 V LED 3 W 3000 K 100 lm Ra 80 IP54

R12613 branco

€ 58

R12615 preto

€ 58

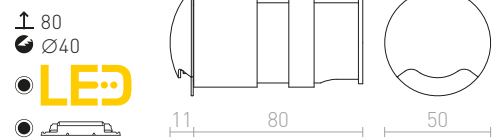

KICK II EMBUTIDA

230 V LED 3 W 3000 K 120 lm Ra 80 IP54

R12616 branco

€ 58

R12617 alumínio escovado

€ 48

R12618 preto

€ 58

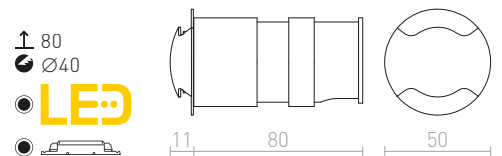

KICK III EMBUTIDA

230 V LED 3 W 3000 K 150 lm Ra 80 IP54

R12619 branco

€ 58

R12621 preto

€ 58

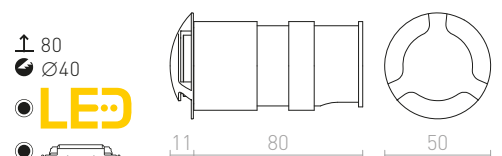



AMARO

Aplique LED adequado como luz de orientação para corredores e escadas.

AMARO

230 V LED 1 W $\angle 60^\circ$ 3000 K 95 lm Ra 80

R12690 branco

€ 35

± 70

● Ø40



● LED

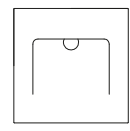
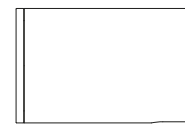

3 65

45



IP54



PER

Aplique LED adequado para uso interior e exterior como luz de orientação para corredores e escadas.

PER EMBUTIDA

230 V LED 3 W 3000 K 76 lm Ra 80 IP54

R12576 branco

€ 58

R12577 cinzento antracite

€ 58

↑ 60

▣ 65x102



LED

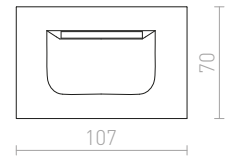

IP54



TESS

Aplique quadrado embutido adequado para uso interior e exterior. Instale apenas para iluminação descendente. Disponível em três cores diferentes. Caixa de montagem incluída.

TESS SQ EMBUTIDA

230 V LED 3 W 3000 K 80 lm Ra 80 IP54

R12013 branco

€ 58

R12014 cinzento prata

€ 58

R12015 cinzento antracite

€ 58

↑ 70

▣ 60x55



LED

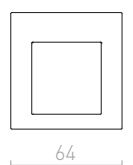
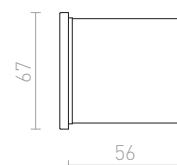



RAGG

Iluminação de embutir para exterior com luz direcional para iluminar calçadas e escadas.

RAGG EMBUTIDA

230 V LED 12 W 3000 K 406 lm Ra 80 IP65

R13620 branco

€ 120

R13621 preto

€ 120

↑ 80

↙ 80x230



LED

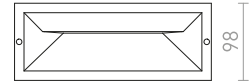

5 85

250



RASQ

Luminária embutida LED para uso interior e exterior. Adequada como iluminação de orientação de passeios, escadas ou terraços. Instale apenas para iluminação descendente.

RASQ EMBUTIDO NA PAREDE

230 V LED 9 W 3000 K 190 lm Ra 80 IP65

R12627 branco

€ 178

R12628 cinzento antracite

€ 178

↑ 80

↙ 237x77



LED

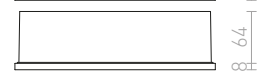
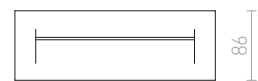

250

IP65



INTRO

Luminária embutida retangular de alumínio escovado com LED integrado. O painel frontal tem 0,3 cm de espessura. Fornecida com uma caixa de montagem. Apenas para ligação em série.

INTRO L

350 mA LED 3 W 3000 K 185 lm Ra 80

R10598 alumínio escovado

€ 68 %

↑ 60

▣ 86x146



● LED

○ G13124

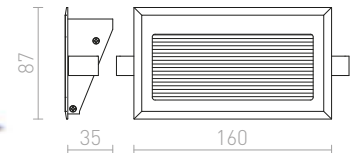

INTRO

Luminária embutida com LED integrado. O painel frontal tem 0,3 cm de espessura. Fornecida com uma caixa de montagem. Apenas para ligação em série.

INTRO M

350 mA LED 1 W 3000 K 40 lm Ra 80

R10606 alumínio escovado

€ 68 ➔

↑ 50

▣ 86x86



● LED

○ G13124

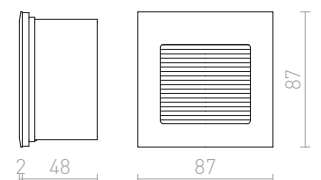





IP65



IP65



IP65



GORDIQ

Luminária embutida LED para iluminação direcional de pavimentos, escadas ou terraços. Apenas iluminação descendente.

GORDIQ L EMBUTIDA

230 V LED 3 W 3000 K 90 lm Ra 80 IP65

R12537 branco

€ 78

R12538 cinzento antracite

€ 78

↑ 60

▣ 115x50

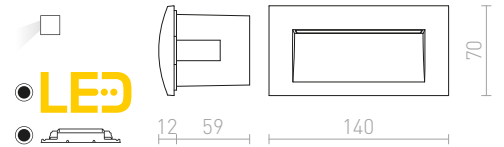

LED



GORDIQ M EMBUTIDA

230 V LED 3 W 3000 K 90 lm Ra 80 IP65

R12535 branco

€ 88

R12536 cinzento antracite

€ 88

↑ 60

▣ 115x108

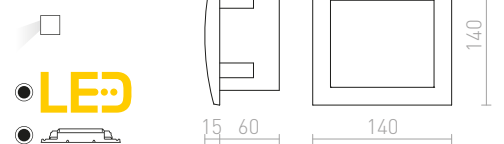

LED



GORDIQ S EMBUTIDA

230 V LED 1,5 W 3000 K 30 lm Ra 80 IP65

R12533 branco

€ 68

R12534 cinzento antracite

€ 68

↑ 60

▣ 75x72

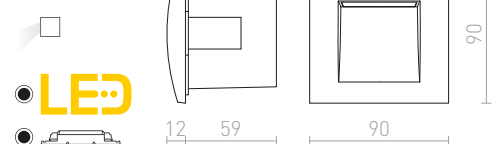

LED





IP65



IP65



IP65

DEJAVU

Luminária embutida LED para montagem em parede para iluminação direcional de pavimentos, escadas ou terraços.

DEJAVU RC EMBUTIDA

230 V LED 4 W 3000 K 130 lm Ra 80 IP65

R12532 preto

€ 88 →

- ↑ 70
- ▣ 57x120
- LED
- 

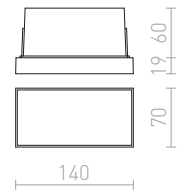

DEJAVU SQ 9 EMBUTIDA

230 V LED 3,5 W 3000 K 120 lm Ra 80 IP65

R12530 preto

€ 68 %

- ↑ 70
- ▣ 72x75
- LED
- 

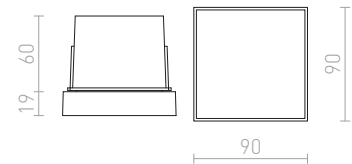

DEJAVU SQ 14 EMBUTIDA

230 V LED 6 W 3000 K 270 lm Ra 80 IP65

R12531 preto

€ 78 %

- ↑ 70
- ▣ 108x125
- LED
- 

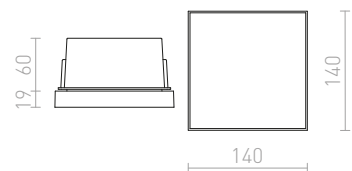





CALHAS TRIFÁSICAS

3F TRIFÁSICO	494-499
3F FOCOS	500-517
3F SUSPENSOS	518-531

SISTEMA DE CALHAS MONOFÁSICAS

MONOFÁSICO	532-535
1F FOCOS	536-545
1F SUSPENSOS	546-551

FITAS LED

FITAS LED	552-557
PERFIS	558-561



CALHAS TRIFÁSICAS 3F TRIFÁSICO



494-499



494-499



494-499

494-499

CALHAS TRIFÁSICAS 3F FOCOS



FLATLINE 60
500-501



FLATLINE 150
500-501



FOCUS 12
502-503

500-517



FOCUS 20
502-503



FOCUS 30
502-503



ZUMA
504-505



WISH 20
504-505



WISH 30
504-505



OPTIMUS
504-505



MAVRO
506-507



MAVRO
506-507



TRAX
506-507



LOLLIPOP
506-507



BAHIA
508-509



FANGIO
508-509



PRODIGI L
508-509



PRODIGI S
508-509



CADENZA
510-511



DARIO
510-511



CONNOR
510-511



DUDE
512-513



BELENOS
512-513



FORZA
512-513



BEEBA I
514-515



BEEBA II
514-515



PURINA
514-515



TRICA
514-515



PIXIE
516-517



FAX E27
516-517



FAX
516-517



KELLY LED
516-517



PIXIE
516-517

CALHAS TRIFÁSICAS 3F SUSPENSOS



ASTON
518-519



BLONDIE 25
518-519



BUCKY 40
518-519

518-531



MONROE 30
518-519



SINTRA 30
520-521



MERYLYN 34
520-521



DESTY
520-521



BELENOS
520-521



BABADES
520-521



BELLINI
522-523



TUTTI
522-523



FRUTTI
522-523



CHOUPETTE
522-523



JULIETTA 16
524-525



JULIETTA 31
524-525



EIGHT
524-525



COPA
524-525



SANSSOUCI
526-527



CALHA MONOFÁSICA MONOFÁSICO



532-535

532-535

532-535

CALHA MONOFÁSICA 1F FOCOS



536-545

FOCUS 12
536-537

FOCUS 20
536-537

OPTIMUS
536-537

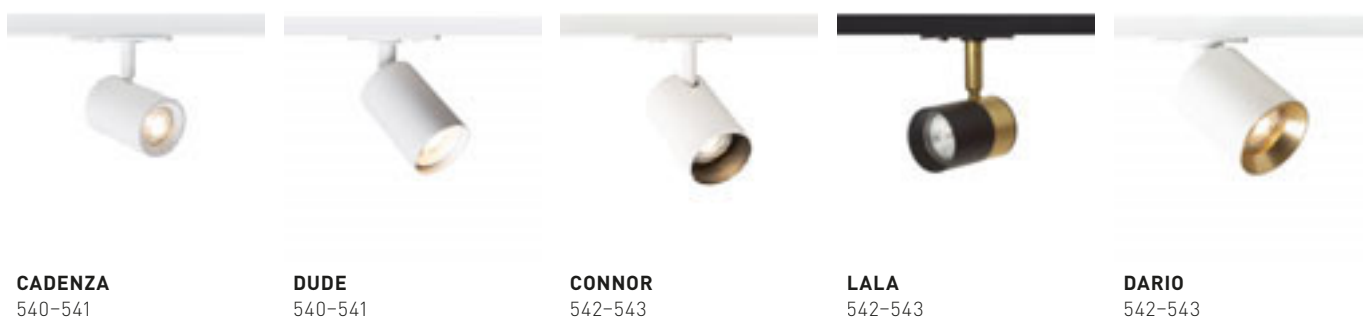
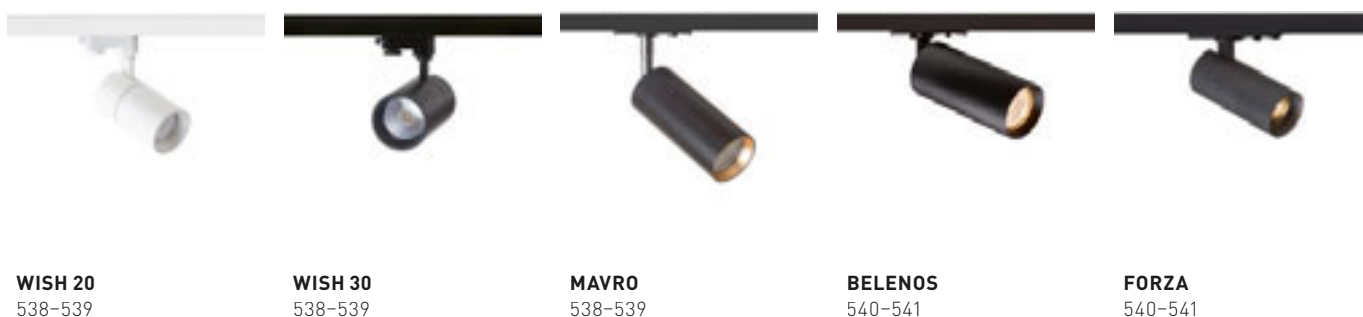

CALHA MONOFÁSICA 1F SUSPENSOS

546-551



JULIETTA 16
546-547



JULIETTA 31
546-547



PULIRE RD
546-547



PULIRE CON
546-547



BABADES
548-549



BELENOS
548-549



ICAR
548-549



CHOUPETTE
548-549



BLONDIE 25
550-551



COPA
550-551



DESTY
550-551



ELISA
550-551

FITAS LED FITAS LED

552-557



LED STRIP ORION RGB
552-553



LED STRIP ORION RGBW
552-553



EM 1
552-553



LEDSTRIP ORION 60, 100, 150
552-553



LED STRIP ORION
554-555



LED STRIP IP20 5m
556-557



LED STRIP IP54 5m
556-557



LED STRIP
556-557



LED STRIP
556-557



LED STRIP IP54
556-557



LED STRIP IP20
556-557

FITAS LED PERFIS

558-561



LED PROFILE A
558-559



LED PROFILE B
558-559



LED PROFILE D
558-559



LED PROFILE F
560-561



LED PROFILE E
560-561



LED PROFILE C
560-561

EUTRAC

CALHA TRIFÁSICA

Calha trifásica EUTRAC. Qualquer perfil pode ser facilmente cortado para o comprimento desejado. Não é necessário cortar ou dobrar as extremidades dos fios. Ao usar fontes de halogéneo, a altura mínima de instalação é de 2,5 m. Para uso abaixo desta altura, recomendamos a substituição por fontes de LED. NOTA: Custos adicionais de frete podem ocorrer em pedidos de 3 m de calhas.

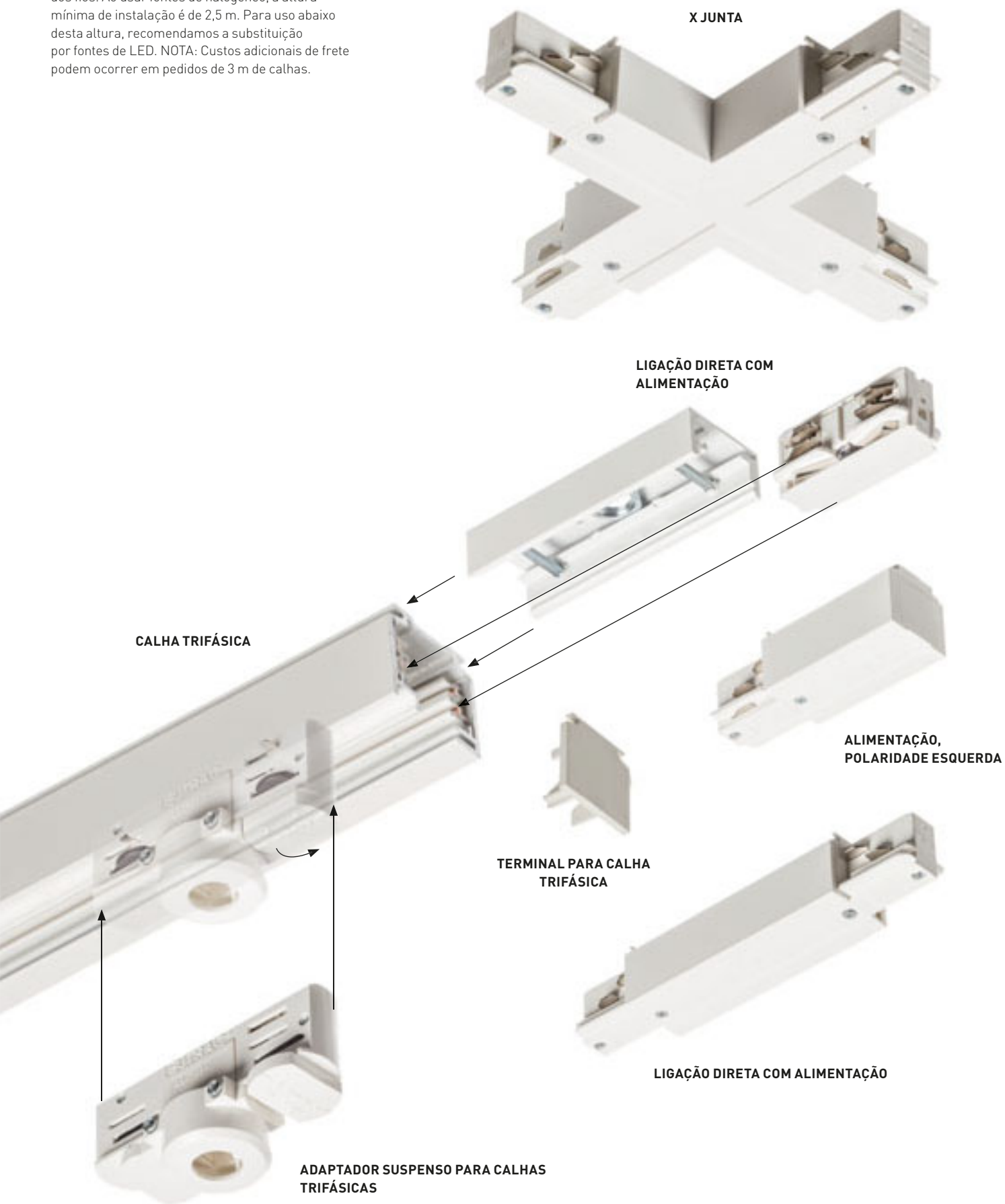

L JUNTA POLARIDADE INTERNA



L JUNTA POLARIDADE EXTERNA



SUSPENSÃO DE ARAME



JUNTA CONETORA PARA CALHAS TRIFÁSICAS



BRAÇADEIRA PARA CALHAS TRIFÁSICAS

LIGAÇÃO DIRETA, ELÉTRICA



T JUNTA, POLARIDADE ESQUERDA

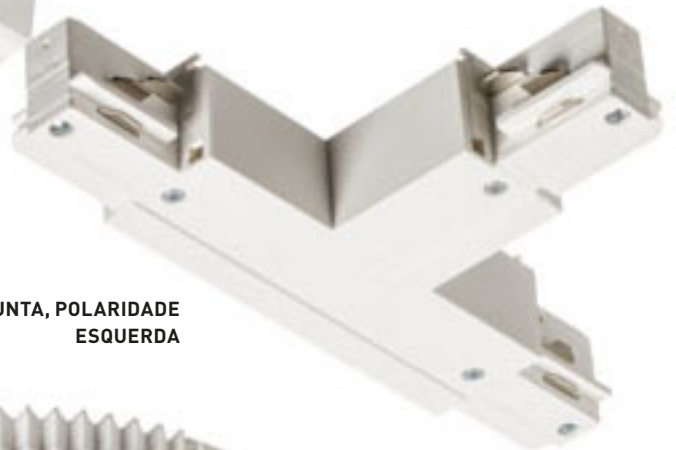

LIGAÇÃO FLEXÍVEL



ADAPTADOR MECÂNICO



EUTRAC

CALHA TRIFÁSICA

Calha trifásica EUTRAC. Qualquer perfil pode ser facilmente cortado para o comprimento desejado. Não é necessário cortar ou dobrar as extremidades dos fios. Ao usar fontes de halogéneo, a altura mínima de instalação é de 2,5 m. Para uso abaixo desta altura, recomendamos a substituição por fontes de LED. NOTA: Custos adicionais de frete podem ocorrer em pedidos de 3 m de calhas.

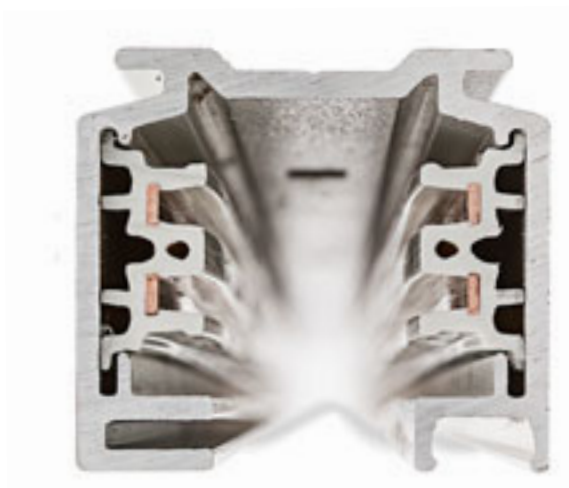

1M CALHA TRIFÁSICA

230 V	
R12072 branco	€ 98
R12073 preto	€ 98
R12074 cinzento prata	€ 98

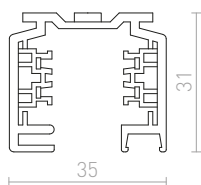

L JUNTA POLARIDADE INTERNA

L-ligação com fonte de alimentação para calha trifásica EUTRAC. Carga máxima 16A.

230 V	
R11326 branco	€ 78
R11327 preto	€ 78
R11328 cinzento prata	€ 120

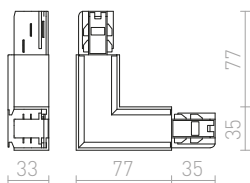

L JUNTA POLARIDADE EXTERNA

Ligação em L com fonte de alimentação para calhas trifásicas EUTRAC. Carga máxima 16A.

230 V	
R11323 branco	€ 78
R11324 preto	€ 78
R11325 cinzento prata	€ 120

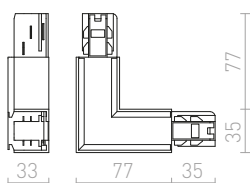

2M CALHA TRIFÁSICA

230 V	
R11300 branco	€ 158
R11301 preto	€ 158
R11302 cinzento prata	€ 158

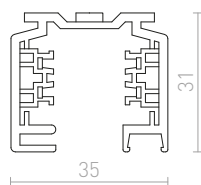

T JUNTA POLARIDADE DIREITA

Ligação em T com fonte de alimentação para calhas trifásicas EUTRAC. Carga máxima 16A.

230 V	
R11332 branco	€ 120
R11333 preto	€ 120
R11334 cinzento prata	€ 158

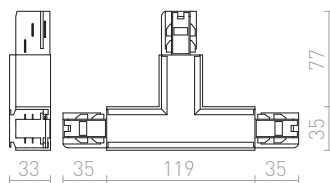

T JUNTA, POLARIDADE ESQUERDA

Ligação em T com fonte de alimentação para calhas trifásicas EUTRAC. Carga máxima 16A.

230 V	
R11335 branco	€ 120
R11336 preto	€ 120
R11337 cinzento prata	€ 158

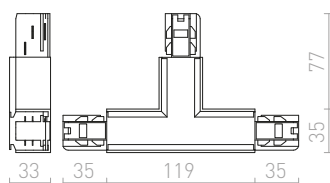

3M CALHA TRIFÁSICA

230 V	
R11303 branco	€ 238
R11304 preto	€ 238
R11305 cinzento prata	€ 238

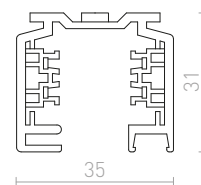

ALIMENTAÇÃO, POLARIDADE DIREITA

Fonte de alimentação terminal para calhas trifásicas EUTRAC. Carga máxima 16A.

230 V	
R11311 branco	€ 35
R11312 preto	€ 35
R11313 cinzento prata	€ 48

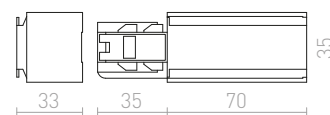

ALIMENTAÇÃO, POLARIDADE ESQUERDA

Fonte de alimentação terminal para calhas trifásicas EUTRAC. Carga máxima 16A.

230 V	
R11314 branco	€ 35
R11315 preto	€ 35
R11316 cinzento prata	€ 48

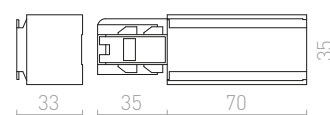

LIGAÇÃO DIRETA, ELÉTRICA

Articulação condutora longitudinal para calhas trifásicas EUTRAC. Por razões estáticas, é necessária uma junta mecânica (R11354, R11355 ou R11356) para a montagem da suspensão. Carga máxima 16A.

230 V

R11317 branco	€ 24
R11318 preto	€ 24
R11319 cinzento prata	€ 29

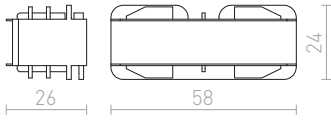

LIGAÇÃO FLEXÍVEL

Articulação condutora flexível para calhas trifásicas EUTRAC. Raio 30° -330°. Com esta ligação é possível alimentar o sistema de calhas. Carga máxima 16A.

230 V

R11329 branco	€ 120
R11330 preto	€ 120
R11331 cinzento prata	€ 120

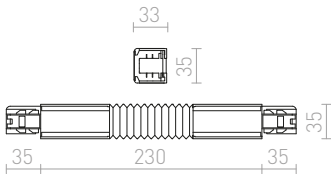

LIGAÇÃO DIRETA COM ALIMENTAÇÃO

Ligação longitudinal condutora com fonte de alimentação para calhas trifásicas EUTRAC. Carga máxima 16A.

230 V

R11320 branco	€ 78
R11321 preto	€ 78
R11322 cinzento prata	€ 120



X JUNTA

Ligação em X com fonte de alimentação para calhas trifásicas da EUTRAC. Possibilidade de ligar dois circuitos. Carga máxima 16A.

230 V

R11338 branco	€ 150
R11339 preto	€ 150
R11340 cinzento prata	€ 198

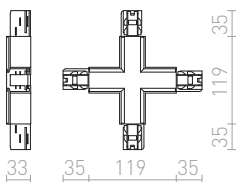

LIGAÇÃO DIRETA COM ALIMENTAÇÃO

Fonte de alimentação terminal para calhas trifásicas EUTRAC sem necessidade de dividir a calha. Carga máxima 16A.

230 V

R11346 branco	€ 58
R11347 preto	€ 58
R11348 cinzento prata	€ 78

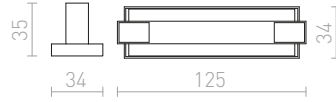

ADAPTADOR SUSPENSO PARA CALHAS TRIFÁSICAS

Cargas máximas de 5 kg e 10A.

230 V

R11360 branco	€ 32
R11361 preto	€ 32
R11362 cinzento prata	€ 48

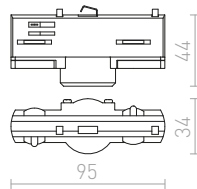

TERMINAL PARA CALHA TRIFÁSICA

Terminais para calhas trifásicas EUTRAC.

R11307 branco	€ 3.20
R11308 preto	€ 3.20
R11309 cinzento prata	€ 6

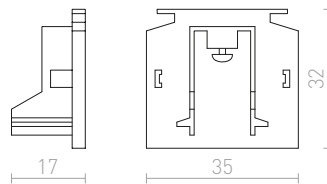

ADAPTADOR MECÂNICO

Adaptador mecânico montado em superfície e embutido para calhas trifásicas EUTRAC. Carga máxima de 10 kg.

R11352 branco	€ 25
R11353 preto	€ 25

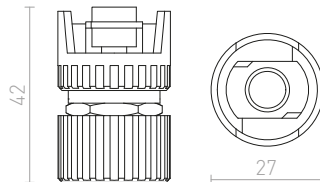

3M SUSPENSÃO DE ARAME

Fios para calhas trifásicas EUTRAC. Casquilho M13.

R11359	€ 48
---------------	-------------

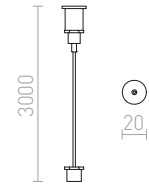

1,5M SUSPENSÃO DE ARAME

Fios para calhas trifásicas EUTRAC. Casquilho M13.

R11358	€ 48
---------------	-------------

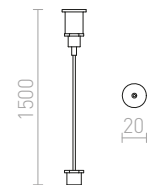

BRACEIRA PARA CALHAS TRIFÁSICAS

Adaptador para fixar o cabo suspenso. Casquilho M13.

R11349 branco	€ 14
R11350 preto	€ 14
R11351 cinzento prata	€ 16

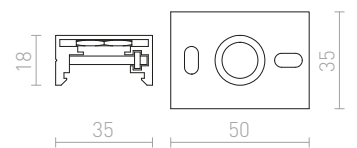

JUNTA CONETORA PARA CALHAS TRIFÁSICAS

A junta mecânica deve ser utilizada para reforçar os sistemas de calhas suspensas no ponto de interligação de cada calha com uma ligação condutora longitudinal.

R11354 branco	€ 24
R11355 preto	€ 24
R11356 cinzento prata	€ 26

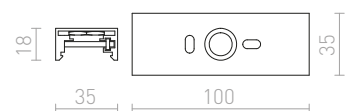

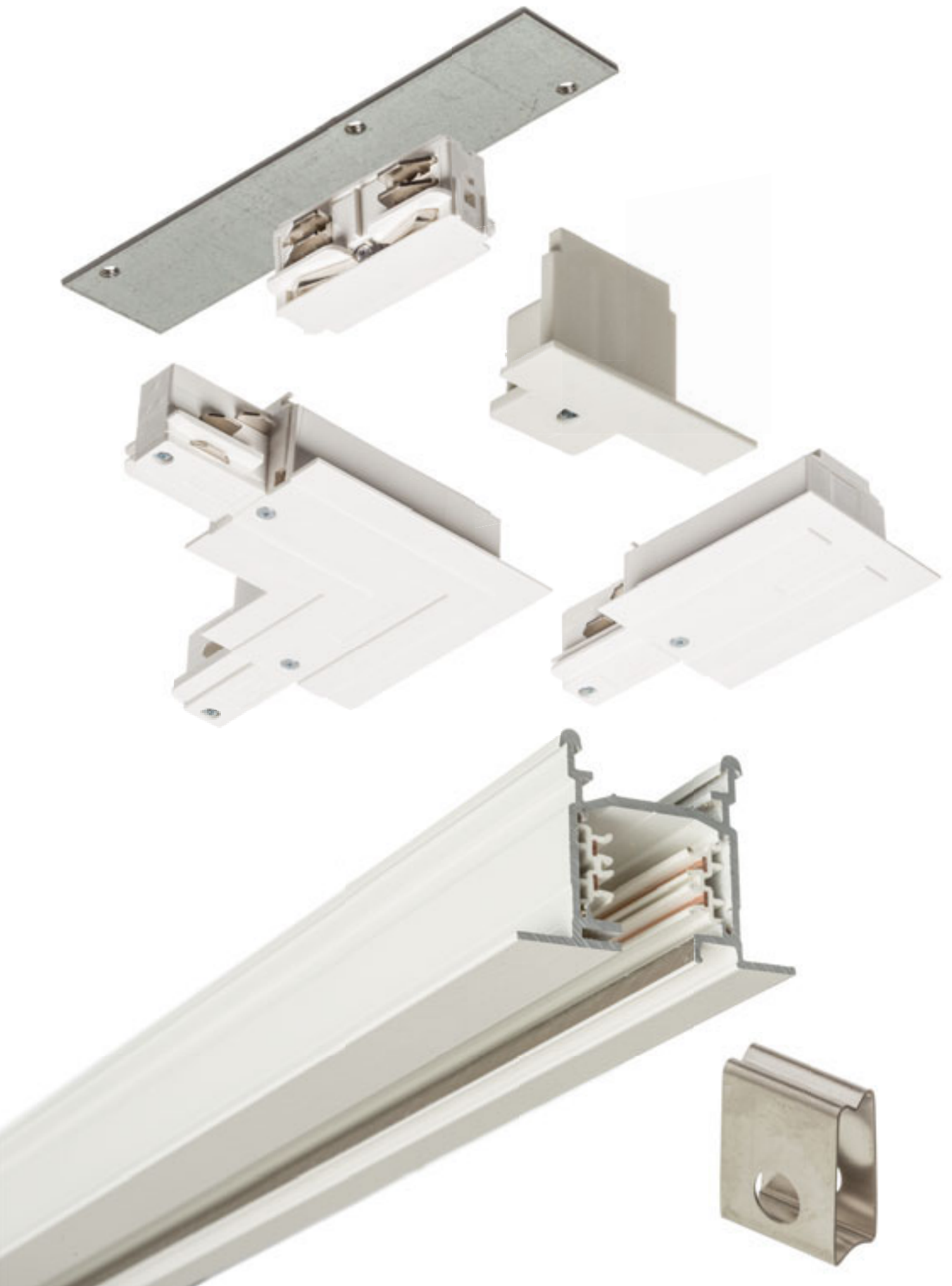

CALHA TRIFÁSICA EMBUTIDA

Sistema de calha trifásica embutida em perfil de alumínio extrudido, que também serve de aterramento. No interior, são inseridos dois perfis de plástico, levando quatro fios de cobre de 2,5 mm de diâmetro. Qualquer perfil pode ser facilmente cortado para o comprimento desejado. Não é necessário cortar ou dobrar as extremidades dos fios. Ao usar fontes de halógeno, a altura mínima de instalação é de 2,5 m. Abaixo desta altura, recomendamos a substituição de fontes LED.

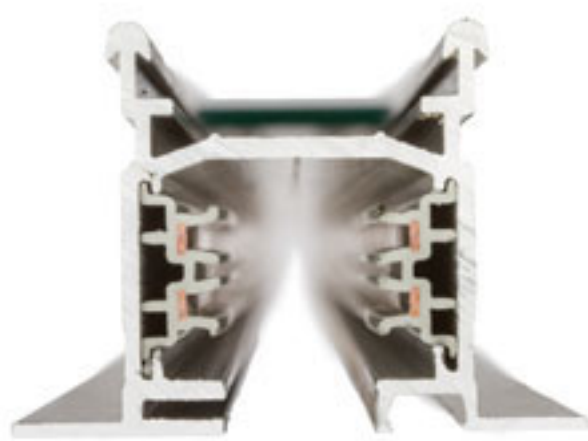

ALIMENTAÇÃO PARA CALHAS TRIFÁSICAS EMBUTIDAS, POLARIDADE ESQUERDA

Fonte de alimentação terminal para calha trifásica embutida EUTRAC. Possibilidade de carregar até 16A.

230 V
R11342 branco € 48

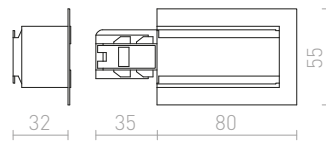

ALIMENTAÇÃO PARA CALHAS TRIFÁSICAS EMBUTIDA, POLARIDADE DIREITA

Fonte de alimentação terminal para calha trifásica embutida EUTRAC. Possibilidade de carregar até 16A.

230 V
R11341 branco € 48

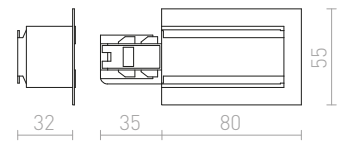

L LIGAÇÃO PARA CALHAS TRIFÁSICAS EMBUTIDAS (POLARIDADE EXTERNA)

Ligação em L com fonte de alimentação para calhas trifásicas EUTRAC. Carga máxima 16A.

230 V
R11344 branco € 88

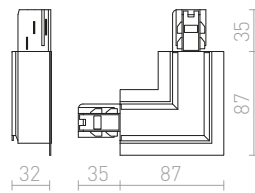

L LIGAÇÃO PARA CALHAS TRIFÁSICAS EMBUTIDAS (POLARIDADE INTERNA)

Ligação em L com fonte de alimentação para calha trifásica EUTRAC. Carga máxima 16A.

230 V
R11345 branco € 88

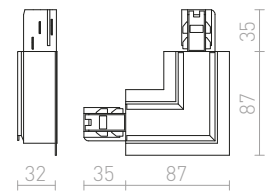

2M CALHA TRIFÁSICA EMBUTIDA

230 V
R11306 branco € 238

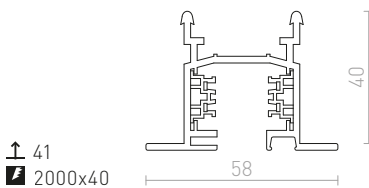

LIGAÇÃO DIRETA PARA CALHAS TRIFÁSICAS, ELÉTRICA

Articulação condutora longitudinal para calhas da EUTRAC. Capacidade de carga até 16A.

230 V
R11343 branco € 32

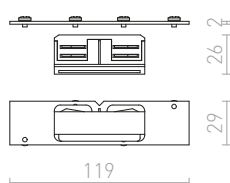

TERMINAL PARA CALHA TRIFÁSICA

Terminais para calhas trifásicas embutidas EUTRAC.

R11310 branco € 8



MOLAS PARA CALHA TRIFÁSICA EMBUTIDA 6 PCS

Clipes de montagem para calhas trifásicas EUTRAC embutidas.

R11357 € 16

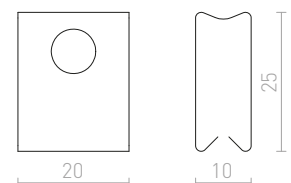





FLATLINE

Luminária linear com iluminação ambiente para calha trifásica. Uma saída de luz diferente pode ser definida no adaptador de luminária: 35W, 40W, 45W ou 50W.

FLATLINE 150 PARA CALHA TRIFÁSICA

230 V LED 50 W $\angle 90^\circ$ 3000 K 8000 lm Ra 80

R13732 branco

€ 268

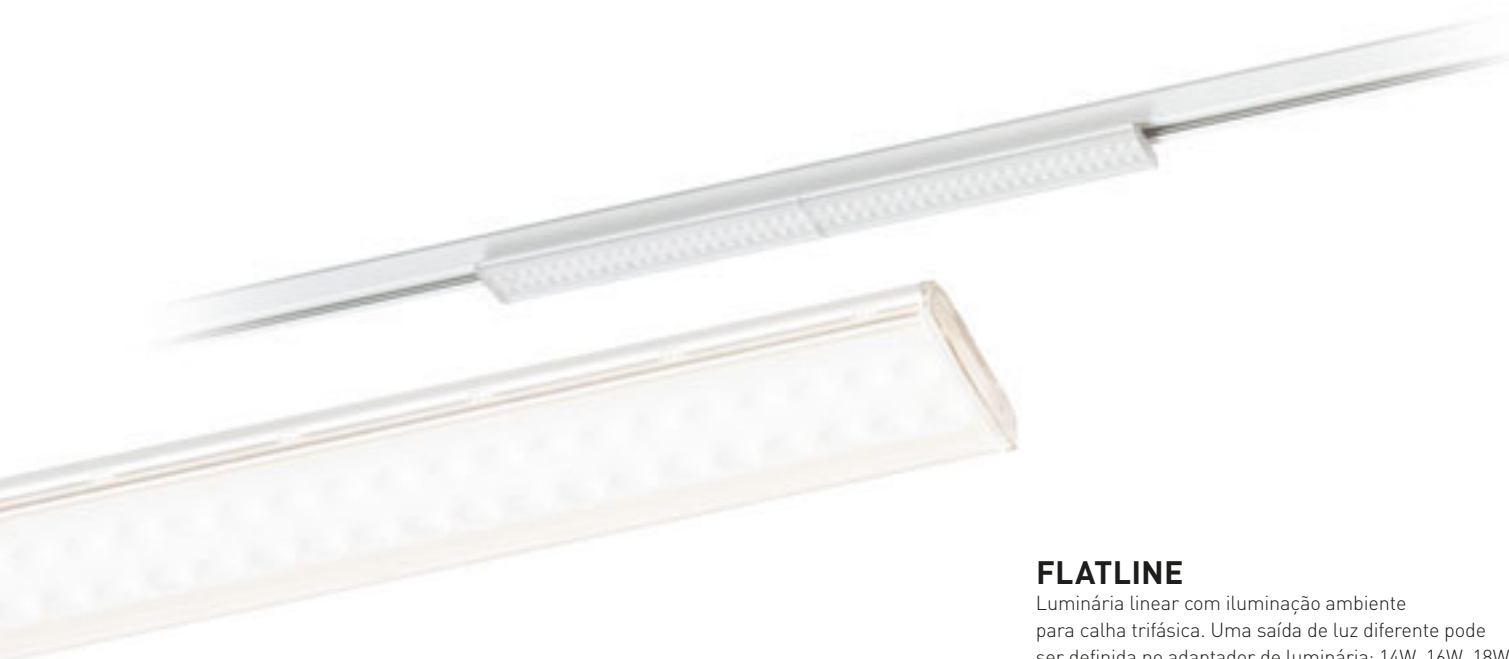
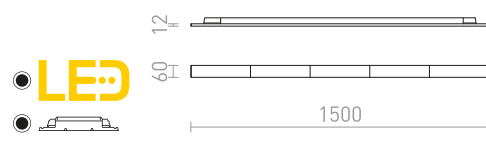

FLATLINE

Luminária linear com iluminação ambiente para calha trifásica. Uma saída de luz diferente pode ser definida no adaptador de luminária: 14W, 16W, 18W ou 20W.

FLATLINE 60 PARA CALHA TRIFÁSICA

230 V LED 20 W $\angle 90^\circ$ 3000 K 3200 lm Ra 80

R13731 branco

€ 198

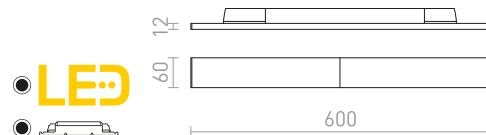





FOCUS

Foco em forma de tubo regulável para calhas trifásicas com a capacidade de alterar o ângulo do feixe entre 10 - 60° com o chamado sistema Zoom. Também pode alterar a temperatura de cor da luz entre 3000K, 4000K, 5000K com um interruptor localizado na parte de trás da luz. Regulação da intensidade da luz TRIAC.

FOCUS 12 DIMM PARA CALHA TRIFÁSICA

230 V LED 12 W $\angle 1060^\circ$ 3000 K 4000 K 5000 K
780 lm Ra 80

R13882 branco

€ 78 NEW

R13883 preto

€ 78 NEW

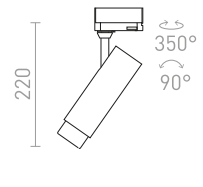

FOCUS 20 DIMM PARA CALHA TRIFÁSICA

230 V LED 20 W $\angle 1060^\circ$ 3000 K 4000 K 5000 K
1540 lm Ra 80

R13884 branco

€ 120 NEW

R13885 preto

€ 120 NEW

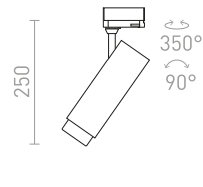

FOCUS 30 DIMM PARA CALHA TRIFÁSICA

230 V LED 30 W $\angle 1060^\circ$ 3000 K 4000 K 5000 K
2300 lm Ra 80

R13886 branco

€ 150 NEW

R13887 preto

€ 150 NEW

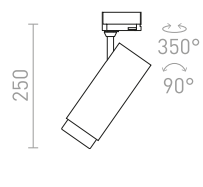



ZUMA

Foco tubular para calhas trifásicas com a possibilidade de ajustar o cone de luz usando um sistema de zoom de 10-50°. Regulação da intensidade da luz TRIAC.

ZUMA DIMM PARA CALHA TRIFÁSICA

230 V LED 20 W $\angle 10-50^\circ$ 3000 K 1000 lm Ra 80

R13529 branco

€ 150

R13531 preto

€ 150

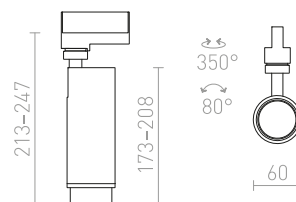

OPTIMUS

Foco cilíndrico para calha trifásica com possibilidade de ajuste do cone de luz mediante sistema de zoom 10-50°. A luminária é adequada para fontes de luz LED com casquilho GU10. Use fontes de luz com um ângulo de feixe de 120° na luminária para evitar sombras indesejadas.

OPTIMUS PARA CALHA TRIFÁSICA

230 V LED GU10 9 W $\angle 10-50^\circ$

R13783 branco

€ 68 NEW

R13784 preto

€ 68 NEW



G12232

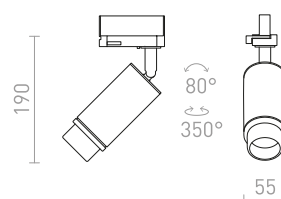



WISH

Luminária cilíndrica regulável para calha monofásica ajustável de cor clara : branco quente (WW), branco neutro (NW), branco frio (CW). Regulação da intensidade da luz TRIAC.

WISH 20 DIMM PARA CALHA TRIFÁSICA

230 V LED 20 W $\angle 36^\circ$ 3000 K 4000 K 5000 K
1600 lm Ra 80

R13773 branco

€ 120 NEW

R13774 preto

€ 120 NEW

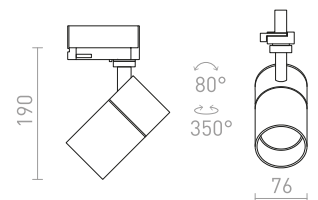

WISH 30 DIMM PARA CALHA TRIFÁSICA

230 V LED 30 W $\angle 36^\circ$ 3000 K 4000 K 5000 K
2400 lm Ra 80

R13775 branco

€ 129 NEW

R13776 preto

€ 129 NEW

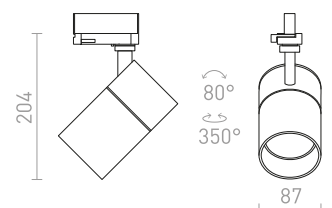



TRAX

Foco LED minimalista para calha trifásica. Interior e exterior têm cores diferentes.

TRAX PARA CALHAS TRIFÁSICAS

230 V/400 mA LED 15 W $\angle 38^\circ$ 3000 K 1460 lm Ra 80

R11693 preto/ouro

€ 129 %

R11694 branco/ouro

€ 129 %

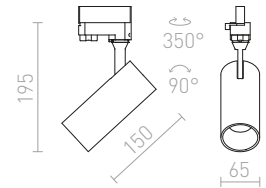

LOLLIPOP

Foco LED cilíndrico para calhas trifásicas. Módulo de LED incluído.

LOLLIPOP PARA CALHA TRIFÁSICA

230 V LED 8 W $\angle 40^\circ$ 3000 K 720 lm Ra 80

R12412 branco

€ 68 %

R12413 preto

€ 68 %

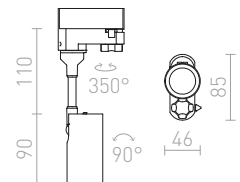

MAVRO

Foco cilíndrico com LED integrado para calhas trifásicas. TRIAC com regulação da intensidade da luz.

MAVRO DIMM PARA CALHA TRIFÁSICA

230 V LED 12 W $\angle 38^\circ$ 3000 K 1020 lm Ra 80

R13171 branco

€ 178

R13172 ouro

€ 178 →

R13173 preto/ouro

€ 178

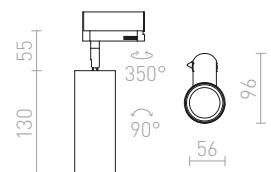

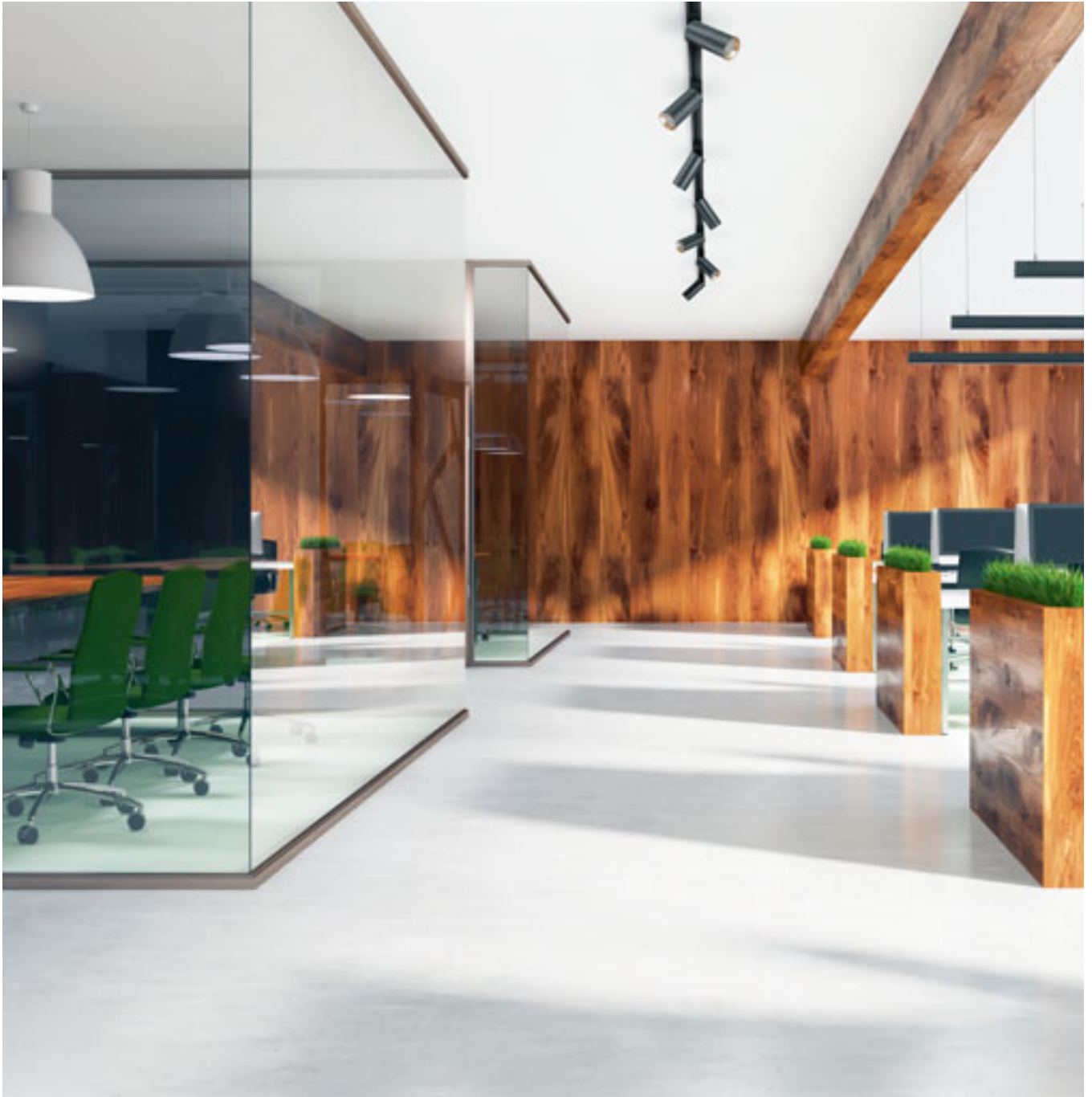

MAVRO

Foco cilíndrico com LED integrado para calhas trifásicas.

MAVRO PARA CALHA TRIFÁSICA

230 V LED 12 W $\angle 38^\circ$ 3000 K 1020 lm Ra 80

R12995 branco

€ 129

R12996 ouro

€ 129 

R12997 preto/ouro

€ 129

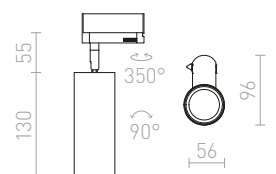



FANGIO

Foco cilíndrico para calha trifásica, em três cores diferentes.

FANGIO PARA CALHA TRIFÁSICA

230 V LED 25 W $\angle 36^\circ$ 3000 K 2200 lm Ra 80

R12059 cinzento prata

€ 98 %

R12060 preto

€ 120 %

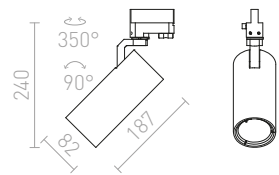



BAHIA

Foco LED de alta potência para calhas trifásicas.

BAHIA PARA CALHA TRIFÁSICA

230 V LED 28 W $\angle 38^\circ$ 3000 K 2700 lm Ra 80

R12823 branco

€ 158

R12824 preto

€ 158

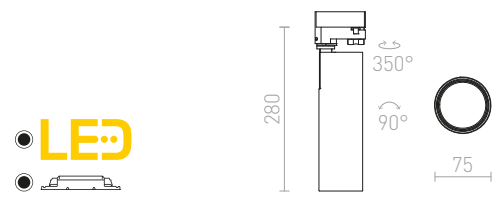

PRODIGI

Foco cilíndrico para calha trifásica. Disponível numa versão de 10W ou 30W LED.

PRODIGI L PARA CALHA TRIFÁSICA

230 V LED 30 W $\angle 36^\circ$ 3000 K 2700 lm Ra 80

R12049 branco

€ 188 %

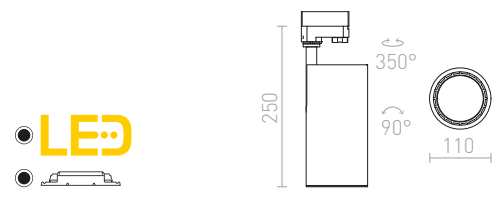

PRODIGI S PARA CALHA TRIFÁSICA

230 V LED 10 W $\angle 36^\circ$ 3000 K 1000 lm Ra 80

R13000 branco

€ 88 %

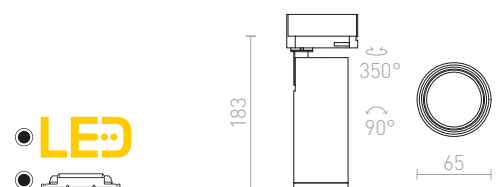

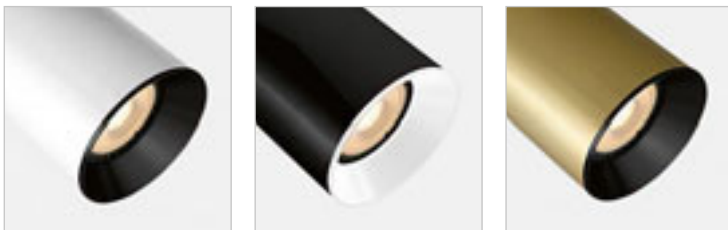
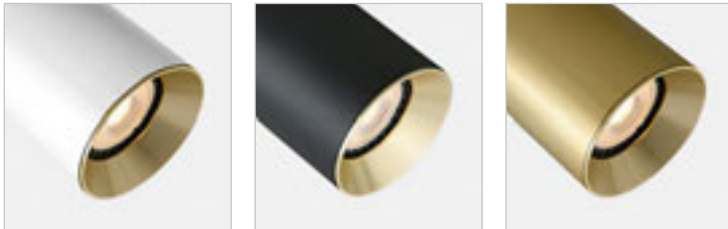

DARIO

Foco cilíndrico com casquilho GU10 para fontes de luz LED, incluindo um tom decorativo de latão preto escovado. Diferentes combinações de cores estão disponíveis comprando tons adicionais em outras cores. Para uso com calhas trifásicas.

DARIO PARA CALHA TRIFÁSICA

230 V GU10 9 W

R13873 branco/latão escovado

€ 98

NEW

R13874 preto/latão escovado

€ 98

NEW

R13875 latão escovado

€ 120

NEW

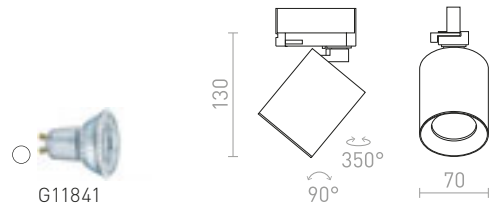

DARIO

Tonalidade decorativa interna de metal em várias cores para a luz DARIO.

DARIO ANEL DECORATIVO

R13876 branco

€ 9.80

NEW

R13877 preto

€ 9.80

NEW

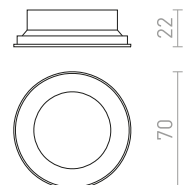



CADENZA

Foco cilíndrico com casquilho GU10 para calhas trifásicas.

CADENZA PARA CALHA TRIFÁSICA

230V LED GU10 10W

R13348 branco

€ 78

R13349 preto

€ 78

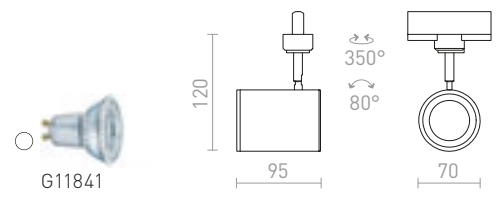

CONNOR

Foco cilíndrico com casquilho GU10 para calhas trifásicas.

CONNOR PARA CALHA TRIFÁSICA

230V LED GU10 10W

R13499 branco/preto

€ 68

R13500 preto/ouro

€ 68

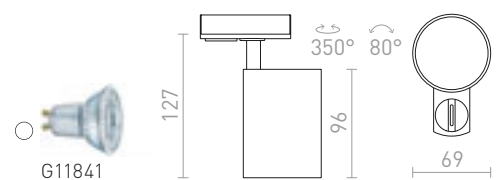



DUDE

Foco cilíndrico com casquilho GU10 para fontes de luz LED e adaptador para calhas trifásicas.

DUDE PARA CALHA TRIFÁSICA

230 V LED GU10 9 W

R13928 branco

€ 68 NEW

R13929 preto

€ 68 NEW

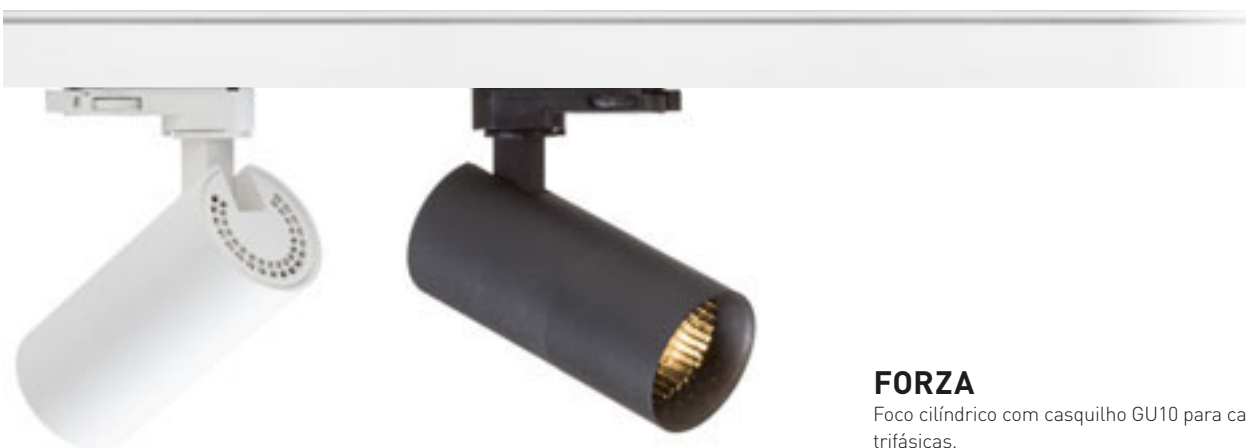
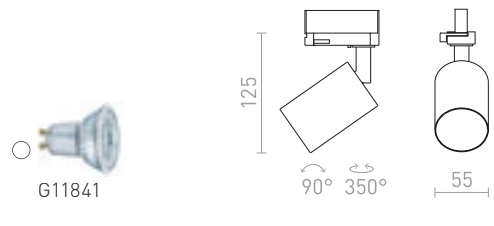

FORZA

Foco cilíndrico com casquilho GU10 para calhas trifásicas.

FORZA PARA CALHA TRIFÁSICA

230 V LED GU10 10 W

R13352 branco

€ 88

R13353 preto

€ 88

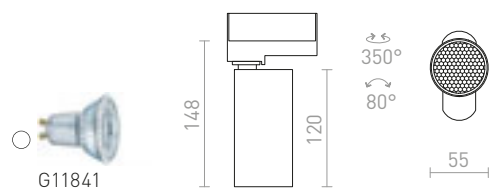

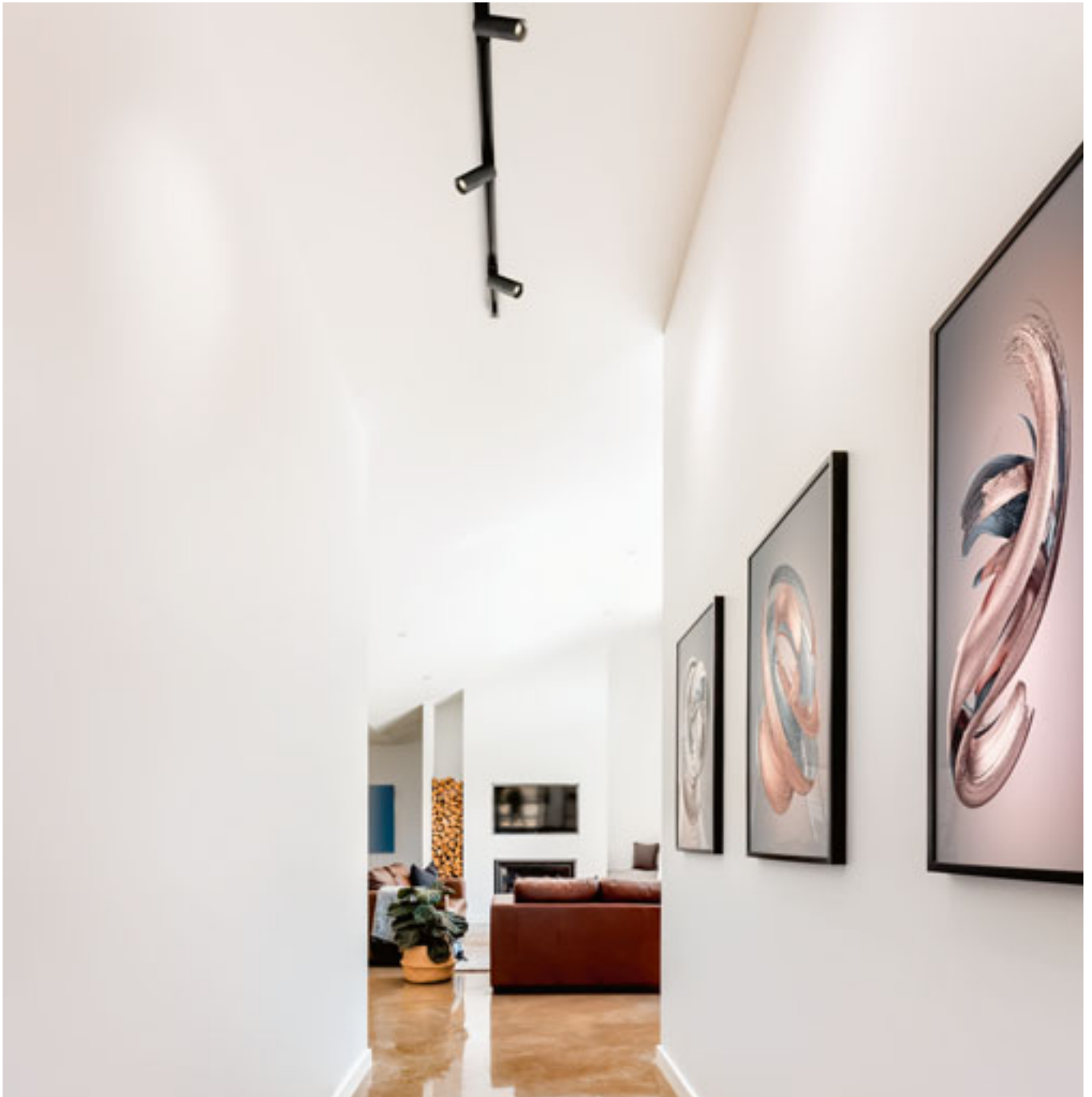

BELENOS

Foco cilíndrico minimalista com casquilho GU10 para calhas trifásicas. As molas ligadas ao casquilho permitem o uso de fontes de luz de vários comprimentos.

BELENOS PARA CALHA TRIFÁSICA

230 V LED GU10 9 W

R13368 branco

€ 68

R13370 preto

€ 68

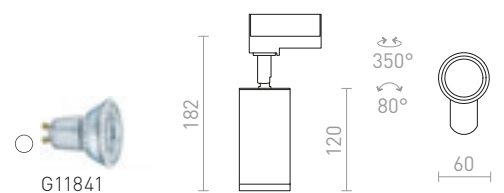



TRICA

Foco com casquilho GU10 para calhas trifásicas. Podem ser usadas fontes de luz com 111 e 51 mm de diâmetro. Todas as medidas são especificadas sem fonte de luz.

TRICA PARA CALHA TRIFÁSICA

230 V GU10 50 W

R12006 preto

€ 35

R12007 branco

€ 35



G12723

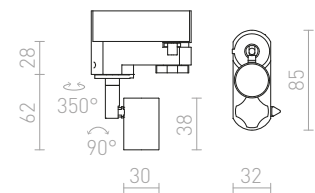



PURINA

Foco para calhas trifásicas com casquilho GU10 em três cores. Inclui um anel decorativo para fontes de luz com diâmetro de refletor de 51 mm. Fontes de luz ES111 também podem ser usadas nesta luminária.

PURINA PARA CALHA TRIFÁSICA

230 V GU10 50 W

R12317 branco € 35 %

R12318 cinzento prata € 35 %

R12319 preto € 48 %



G11841

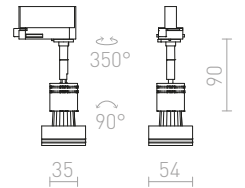

BEEBA

Foco para calhas trifásicas disponível em três cores.

BEEBA I PARA CALHA TRIFÁSICA

230 V GU10 35 W

R12305 branco € 68

R12306 cinzento prata € 58 %

R12307 preto € 68



G11837

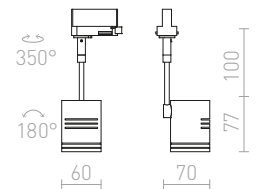

BEEBA II PARA CALHA TRIFÁSICA

230 V GU10 2x35 W

R12311 branco € 98

R12312 cinzento prata € 58 %

R12313 preto € 98



G11837

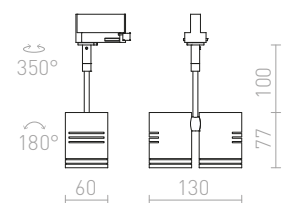



PIXIE

Foco inclinável de alumínio com adaptador para calha trifásica em três cores. Projetado para fontes de luz LED GX53 de baixo consumo energético.

PIXIE EM BRAÇO ARTICULADO PARA CALHAS TRIFÁSICAS

230 V LED GX53 7 W

R10641 cinzento prata/cromo

€ 158 →

R11768 branco

€ 178

R11769 preto

€ 178

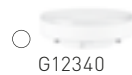

G12340

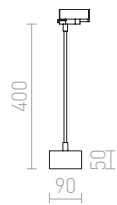

PIXIE PARA CALHAS TRIFÁSICAS

230 V LED GX53 7 W

R10640 cinzento prata/cromo

€ 178

R10644 branco/cromo

€ 178

R10645 preto/cromo

€ 178

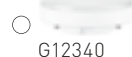

G12340

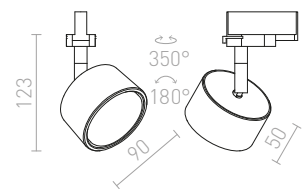



FAX

Foco para calhas trifásicas com casquilho GU10. A fonte de luz pode ser usada com um diâmetro de 111 mm ou 51 mm. Dimensões do corpo da luminária Ø/V 5/6,5 cm. As dimensões do produto são fornecidas sem fonte de luz.

FAX PARA CALHAS TRIFÁSICAS

230 V GU10 50 W

R10564 cinzento prata

€ 48 %

R11723 branco

€ 48 %

R11724 preto

€ 48 %

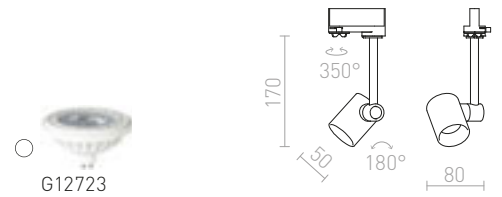

FAX

Foco para calhas simples, adequado para refletores com casquilho E27.

FAX E27 PARA CALHA TRIFÁSICA

230 V E27 25 W

R13535 branco

€ 35

R13537 preto

€ 35

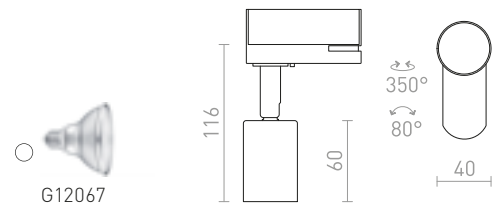

KELLY LED

Foco para calha trifásica. Módulo de LED incluído.

KELLY LED PARA CALHA TRIFÁSICA

230 V LED 12 W ∠24° 3000 K 600 lm Ra 80

R12338 branco

€ 120

R12339 preto

€ 120

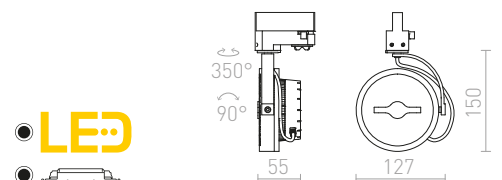



BLONDIE

Luminária suspensa com abajur metálico texturado. O exterior do abajur é em cobre e o interior lacado a branco. Vendido com um cabo preto PVC e adaptador para calhas trifásicas.

BLONDIE 25 PARA CALHA TRIFÁSICA

230 V E27 42 W

R13218 cobre

€ 229

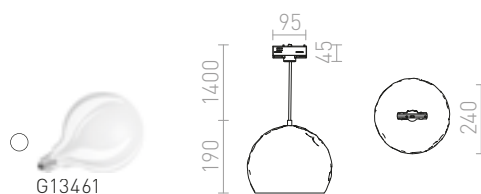



BUCKY

Luminária suspensa de metal com sombra de textura amassada e adaptador para calhas trifásicas.

BUCKY 40 PARA CALHA TRIFÁSICA

230 V E27 28 W

R13859 branco/cinza/metal

€ 178

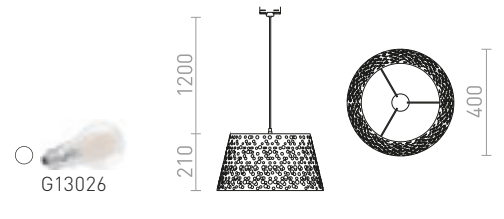

ASTON

Candeeiro suspenso com abajur de alumínio e adaptador para calhas trifásicas.

ASTON PARA CALHA TRIFÁSICA

230 V E27 42 W

R12100 alumínio escovado

€ 120

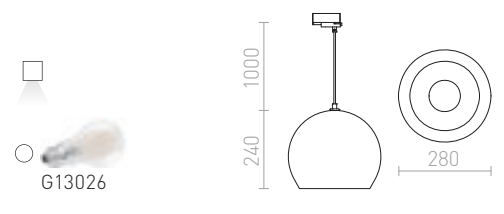

MONROE

Luminária suspensa com abajur metálico lacado a preto e adaptador para calha trifásica.

MONROE 30 PARA CALHA TRIFÁSICA

230 V E27 42 W

R12101 mate preto/branco

€ 178

R13819 cobre

€ 158

NEW

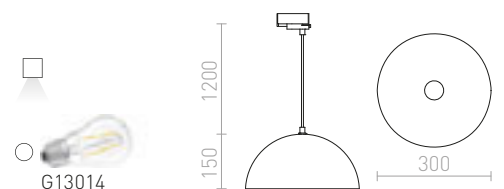



MERYLYN

Luminária suspensa cônica de metal para casquilho E27. Cabo com adaptador para calhas trifásicas.

MERYLYN 34 PARA CALHA TRIFÁSICA

230 V E27 28 W

R13220 preto/branco

€ 158 →

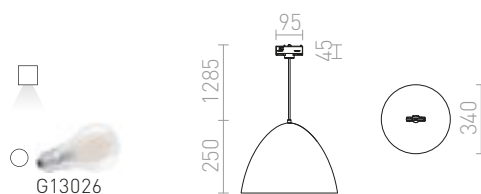

BELENOS

Luminária suspensa cilíndrica minimalista para fontes de luz GU10 numa base redonda. Molas presas ao casquilho permitem o uso de fontes de luz de vários comprimentos. O cabo é ligado a um adaptador para calhas trifásicas.

BELENOS SUSPENSA PARA CALHA TRIFÁSICA

230 V LED GU10 9 W

R13857 branco

€ 88 NEW

R13858 preto

€ 88 NEW

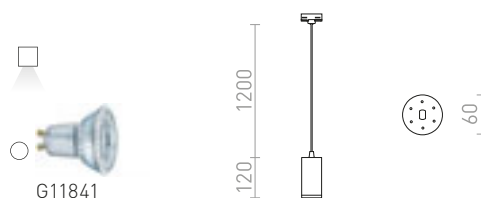



SINTRA

Candeeiro suspenso com abajur de metal cromado e adaptador para calhas trifásicas.

SINTRA 30 PARA CALHA TRIFÁSICA

230 V E27 42 W

R12102 cromo

€ 120 %

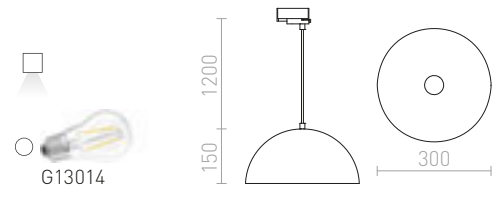

BABADES

Luminária suspensa com abajur e base de teto em cromo ou níquel mate. Cabo têxtil preto com adaptador para calhas trifásicas.

BABADES PARA CALHA TRIFÁSICA

230 V GU10 35 W

R13216 cromo

€ 98

R13217 níquel mate

€ 98

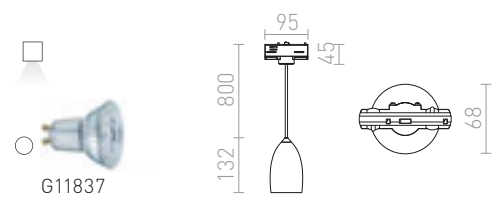

DESTY

Luminária suspensa com abajur metálico para calha trifásica.

DESTY PARA CALHA TRIFÁSICA

230 V GU10 35 W

R13215 preto/cromo

€ 120

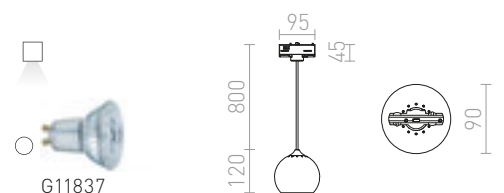



FRUTTI

Luminária suspensa para casquilho E27. O cabo de alimentação termina com um adaptador para calha trifásica.

FRUTTI PARA CALHA TRIFÁSICA

230 V E27 28 W

R13818 verde/cerâmica

€ 78 **NEW**

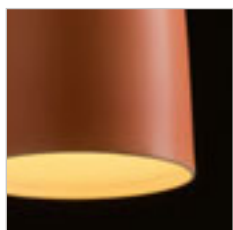
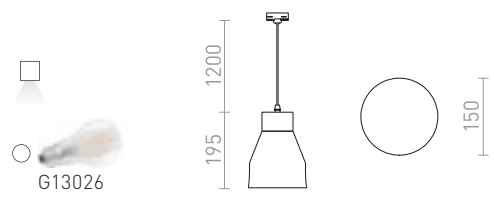

TUTTI

Luminária suspensa cônica para casquilho E27. O cabo de alimentação termina com um adaptador para calha trifásica. Para iluminação descendente.

TUTTI PARA CALHA TRIFÁSICA

230 V E27 15 W

R13817 laranja/cerâmica

€ 98 **NEW**

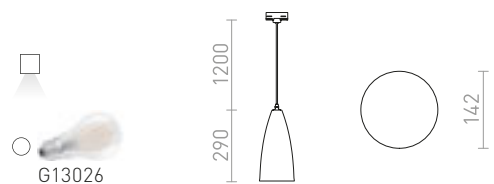



BELLINI

Luminária suspensa de vidro com acessórios lacados para casquilho LED E14. O cabo de alimentação termina com um adaptador para calha trifásica.

BELLINI PARA CALHA TRIFÁSICA

230 V E14 15 W

R13814 branco/vidro transparente

€ 215 **NEW**

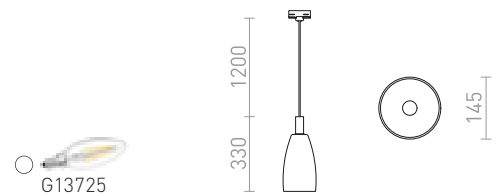

CHOUETTE

Luminária suspensa em tecido com acessório em madeira para fonte de luz LED com casquilho E27 para instalação em calha trifásica.

CHOUETTE PARA CALHA TRIFÁSICA

230 V E27 15 W

R13721 cinzento escuro/têxtil/madeira

€ 150

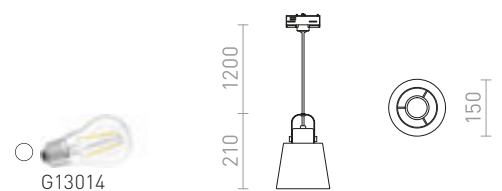



JULIETTA

Luminária suspensa com abajur cilíndrica cor opala, detalhes em metal lacado, cabo têxtil preto e adaptador para calhas trifásicas.

JULIETTA 16 PARA CALHA TRIFÁSICA

230 V E27 20 W

R13855 vidro colorido opala/preto

€ 158

NEW

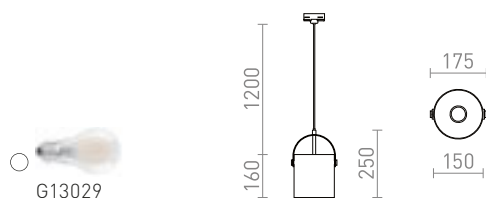

JULIETTA 31 PARA CALHA TRIFÁSICA

230 V E27 20 W

R13856 vidro colorido opala/preto

€ 188

NEW

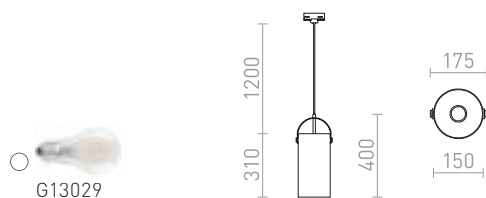

EIGHT

Luminária suspensa com sombra na cor opala, detalhes em cromado e adaptador para calhas trifásicas.

EIGHT SUSPensa PARA CALHA TRIFÁSICA

230 V E27 28 W

R13854 vidro colorido opala/cromo

€ 178

NEW

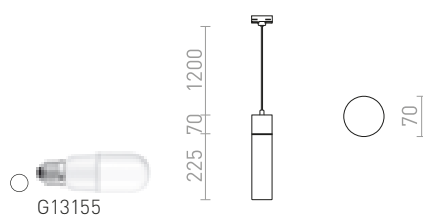



COPA

Luminária suspensa com abajur de vidro para calha trifásica. Disponível em duas cores.

COPA PARA CALHA TRIFÁSICA

230 V E27 28 W

R13207 vidro colorido opala

€ 188

R13208 preto/vidro

€ 198



G13014

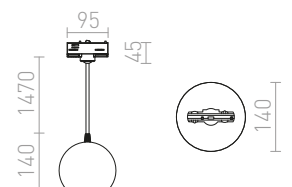



SANSSOUCI

Luminária suspensa com abajur de vidro para calhas trifásicas. A aparência do abajur é reflexiva quando não está iluminada e parcialmente translúcida quando a luz está acesa. O abajur preto não é translúcido.

SANSSOUCI PARA CALHA TRIFÁSICA

230 V E27 42 W

R12095 vidro cromado

€ 138

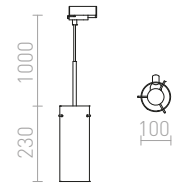

SANSSOUCI PARA CALHA TRIFÁSICA

230 V E27 42 W

R12094 vidro tingido de cobre

€ 138

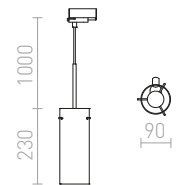

GARNISH

Luminária suspensa com cortina de vidro transparente e acessórios cromados. A cortina de vidro é fechada na parte inferior e é possível inserir nela decorações adequadas. O cabo de alimentação termina com um adaptador para calha trifásica.

GARNISH PARA CALHA TRIFÁSICA

230 V GU10 9 W

R13815 vidro transparente/cromo

€ 158

NEW

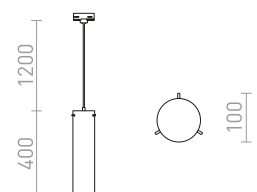



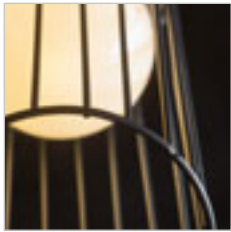

BURTON

Luminária suspensa em cimento com máscara em fio metálico para casquilho E27. O cabo de alimentação termina com um adaptador para calha trifásica.

BURTON PARA CALHA TRIFÁSICA

230 V E27 42 W

R13816 cimento/preto

€ 120 **NEW**

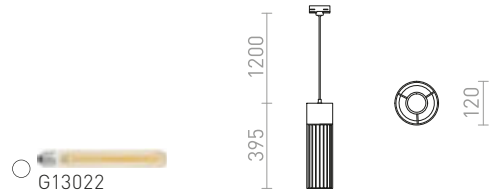

JACK

Luminária suspensa em gesso para fonte de luz com casquilho GU10. Inclui o adaptador na calha trifásica.

JACK RC PARA CALHA TRIFÁSICA

230 V GU10 35 W

R12103 gesso

€ 98 **%**

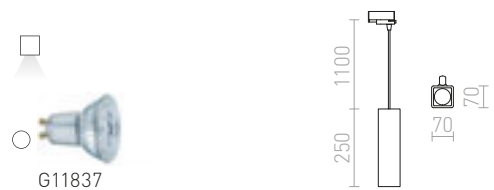

GIFT

Luminária suspensa com um abajur transparente de vidro texturado com um adaptador para calhas trifásicas.

GIFT PARA CALHA TRIFÁSICA

230 V E14 42 W

R12096 vidro transparente

€ 120 **%**

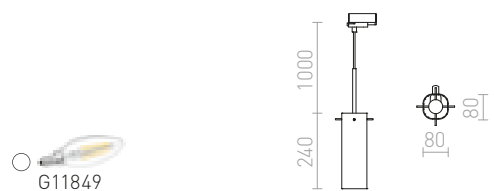





R12106
€ 88

R12107
€ 98

R12108
€ 78

R12109
€ 78

R12110
€ 88

R12111
€ 78

R12112
€ 88

R12113
€ 88

R12114
€ 98



ELISA

Cabo de têxteis em várias combinações de cores com casquilho metálico E27, para uso com uma fonte de luz decorativa ou abajur adequado. O cabo termina com um adaptador para suspensão em calhas trifásicas.

ELISA PARA CALHA TRIFÁSICA

230V E27 28 W

R12106	€ 88
R12107	€ 98
R12108	€ 78
R12109	€ 78
R12110	€ 88
R12111	€ 78
R12112	€ 88
R12113	€ 88
R12114	€ 98

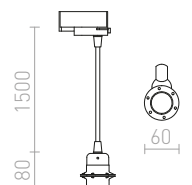

1F CALHA

Calha monofásica para sistema deslizante montado em superfície ou suspenso.

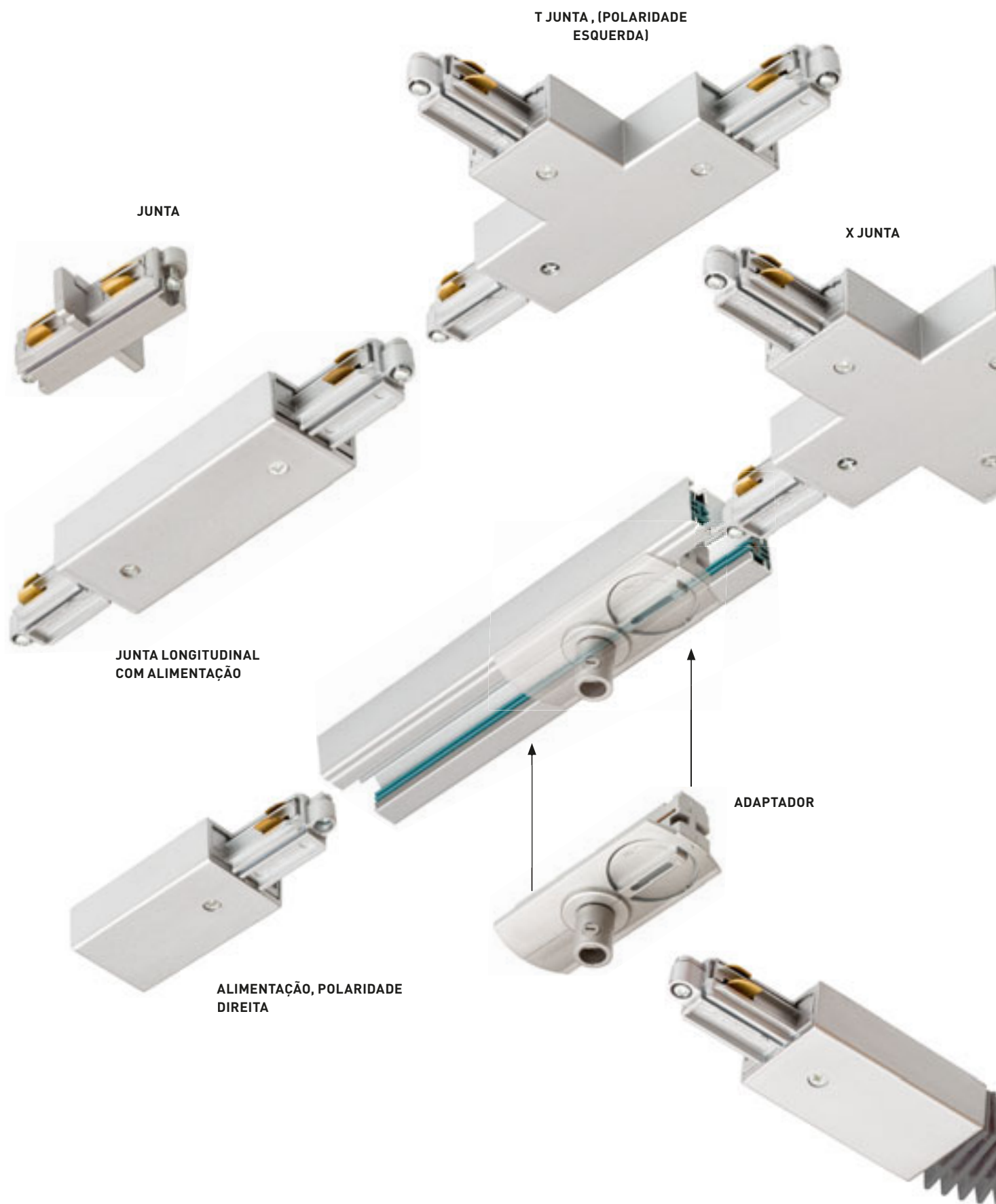

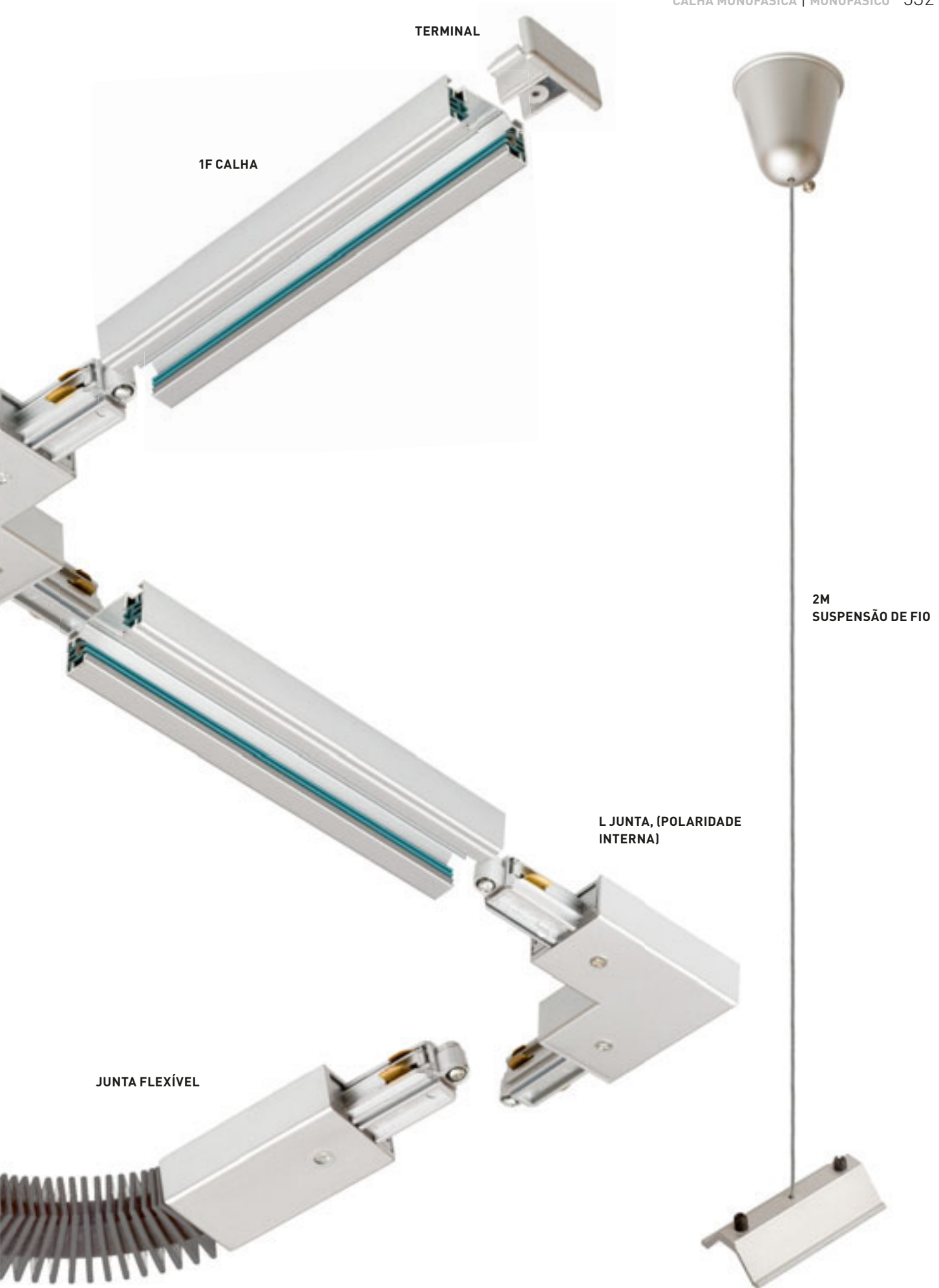

1F CALHA

Calha monofásica para sistema deslizante montado em superfície ou suspenso.



2M CALHA

Calha monofásica para sistema deslizante ou suspenso.

230 V		
R12257 branco	€ 68.00	
R12258 preto	€ 68.00	
R12259 cinzento prata	€ 68.00	

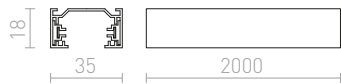

1M CALHA

Calha monofásica para sistema deslizante montado em superfície ou suspenso.

230 V		
R12254 branco	€ 38	
R12255 preto	€ 38	
R12256 cinzento prata	€ 38	



JUNTA LONGITUDINAL COM ALIMENTAÇÃO

Ligação de energia direta. Carga máxima 16A.

230 V		
R12263 branco	€ 9.35	
R12264 preto	€ 9.35	
R12265 cinzento prata	€ 9.20	



X JUNTA

Alimentador X-link para calha monofásica. Carga máxima 16A.

230 V		
R12278 branco	€ 18	
R12279 preto	€ 18	
R12280 cinzento prata	€ 18	

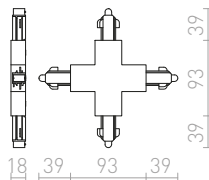

JUNTA

Ligação condutora para calha monofásica.

230 V		
R12260 branco	€ 5	
R12261 preto	€ 5	
R12262 cinzento prata	€ 5	

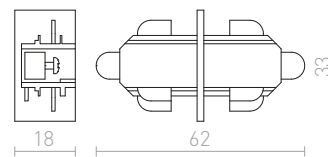

JUNTA FLEXÍVEL

Articulação flexível para calha monofásica. Raio de curvatura 70° -180°. Carga máxima 16A.

230 V		
R12281 branco	€ 17.50	
R12282 preto	€ 17.50	
R12283 cinzento prata	€ 17.50	

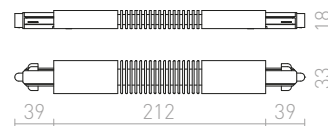



L JUNTA, (POLARIDADE INTERNA)

Ligação L com fonte de alimentação para calhas monofásicas. Carga máxima 16A.

230 V

R12269 branco	€ 9.50
R12270 preto	€ 9.50
R12271 cinzento prata	€ 9.80

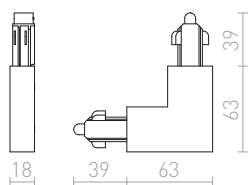

L JUNTA, (POLARIDADE EXTERNA)

L-ligação com fonte de alimentação para calhas monofásicas. Carga máxima 16A.

230 V

R12266 branco	€ 9.50
R12267 preto	€ 9.50
R12268 cinzento prata	€ 9.80

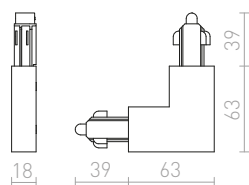

ADAPTADOR

Adaptador para calha monofásica. Com este adaptador, qualquer luz suspensa com um cabo simples (não pode ser usado para um fio de aço) pode ser usada. Carga máxima 16A. Carga mecânica máxima 20N.

230 V

R12293 branco	€ 9
R12294 preto	€ 9
R12295 cinzento prata	€ 9.35

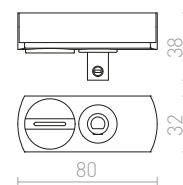

T JUNTA, (POLARIDADE ESQUERDA)

Ligação T com fonte de alimentação para calhas monofásicas. Carga máxima 16A.

230 V

R12272 branco	€ 11.50
R12273 preto	€ 13
R12274 cinzento prata	€ 13.50

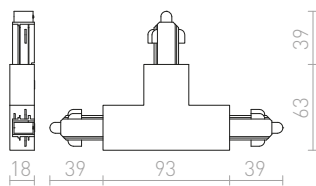

T JUNTA (POLARIDADE DIREITA)

Ligação T com fonte de alimentação para calhas monofásicas. Carga máxima 16A.

230 V

R12275 branco	€ 13
R12276 preto	€ 13
R12277 cinzento prata	€ 13.50

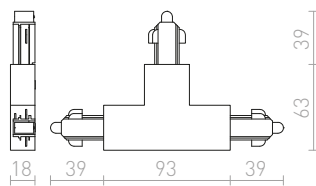

2M

SUSPENSÃO DE FIO

Gancho encaixado para calhas monofásicas.

R12296 branco

€ 8

R12297 preto

€ 8

R12298 cinzento prata

€ 8

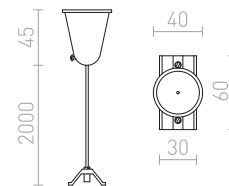

ALIMENTAÇÃO, POLARIDADE ESQUERDA

Fonte de alimentação de terminais para calha monofásica. Carga máxima 16A.

230 V

R12284 branco	€ 5.20
R12285 preto	€ 5.20
R12286 cinzento prata	€ 5.20

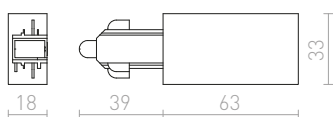

ALIMENTAÇÃO, POLARIDADE DIREITA

Fonte de alimentação de terminais para calha monofásica. Carga máxima 16A.

230 V

R12287 branco	€ 5.20
R12288 preto	€ 5.20
R12289 cinzento prata	€ 5.20

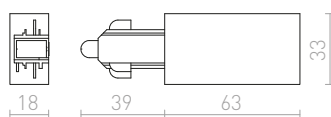

TERMINAL

Terminais para calha monofásica.

R12290 branco

€ 1.35

R12291 preto

€ 1.35

R12292 cinzento prata

€ 1.35

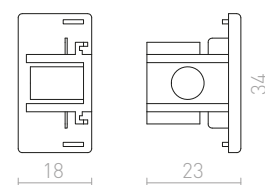



FOCUS

Foco em forma de tubo regulável para calha monofásica com a capacidade de alterar o ângulo do feixe entre 10 - 60° com o chamado sistema Zoom. Também pode alterar a temperatura de cor da luz entre 3000K, 4000K, 5000K com um interruptor localizado na parte de trás da luz. Regulação da intensidade da luz TRIAC.

FOCUS 12 DIMM PARA CALHA MONOFÁSICA

230 V LED 12 W $\angle 1060^\circ$ 3000 K 4000 K 5000 K
780 lm Ra 80

R13878 branco

€ 88 NEW

R13879 preto

€ 88 NEW

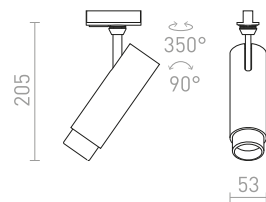

FOCUS 20 DIMM PARA CALHA MONOFÁSICA

230 V LED 20 W $\angle 1060^\circ$ 3000 K 4000 K 5000 K
1540 lm Ra 80

R13880 branco

€ 120 NEW

R13881 preto

€ 120 NEW

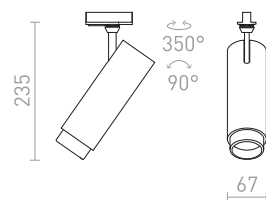



OPTIMUS

Foco cilíndrico para calha monofásica com possibilidade de ajuste do cone de luz mediante sistema de zoom 10-50°. A luminária é adequada para fontes de luz LED com casquilho GU10. Use fontes de luz com um ângulo de feixe de 120° na luminária para evitar sombras indesejadas.

OPTIMUS PARA CALHA MONOFÁSICA

230 V LED GU10 9 W $\angle 1050^\circ$

R13781 branco

NEW

NEW

R13782 preto

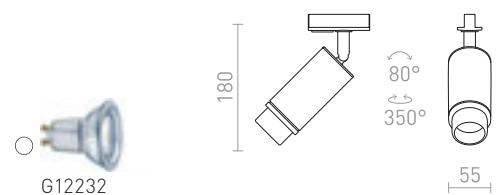



MAVRO

Foco cilíndrico com LED integrado para calhas monofásicas. TRIAC com regulação da intensidade da luz.

MAVRO DIMM PARA CALHA MONOFÁSICA

230 V LED 12 W $\angle 38^\circ$ 3000 K 1020 lm Ra 80

R13163 preto/ouro

€ 158

R13446 branco

€ 158

R13849 ouro

€ 158

NEW

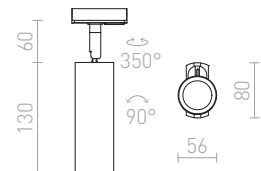

MAVRO

Foco cilíndrico com LED integrado para calhas monofásicas.

MAVRO PARA CALHA MONOFÁSICA

230 V LED 12 W $\angle 38^\circ$ 3000 K 1020 lm Ra 80

R12993 branco

€ 120

R12994 preto/ouro

€ 120

R13848 ouro

€ 120

NEW

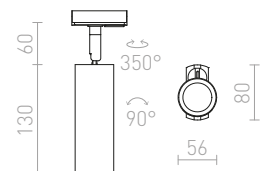



WISH

Luminária cilíndrica regulável para calha monofásica ajustável de cor clara : branco quente (WW), branco neutro (NW), branco frio (CW). Regulação da intensidade da luz TRIAC.

WISH 20 DIMM PARA CALHA MONOFÁSICA

230 V LED 20 W $\angle 36^\circ$ 3000 K 4000 K 5000 K
1600 lm Ra 80

R13769 branco

€ 98

NEW

R13770 preto

€ 98

NEW

● LED

● regulável

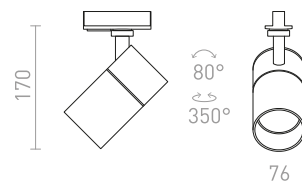

WISH 30 DIMM PARA CALHA MONOFÁSICA

230 V LED 30 W $\angle 36^\circ$ 3000 K 4000 K 5000 K
2400 lm Ra 80

R13771 branco

€ 120

NEW

R13772 preto

€ 120

NEW

● LED

● regulável

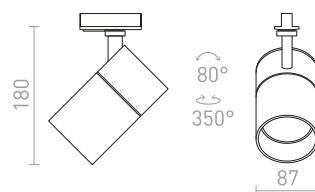



DUDE

Foco cilíndrico com casquilho GU10 para fontes de luz LED e adaptador para calha monofásica.

DUDE PARA CALHA MONOFÁSICA

230 V LED GU10 9 W

R13926 branco

€ 58 NEW

R13927 preto

€ 58 NEW

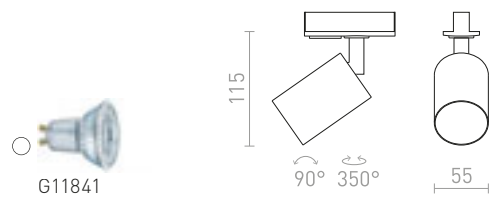

BELENOS

Foco cilíndrico minimalista com casquilho GU10 para calhas monofásicas. As molas ligadas ao casquilho permitem o uso de fontes de luz de vários comprimentos.

BELENOS PARA CALHA MONOFÁSICA

230 V LED GU10 9 W

R13367 branco

€ 68

R13369 preto

€ 68

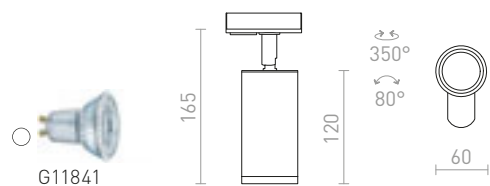



FORZA

Foco cilíndrico com casquilho GU10 para calhas monofásicas.

FORZA PARA CALHA MONOFÁSICA

230 V LED GU10 10 W

R13350 branco

€ 78

R13351 preto

€ 78

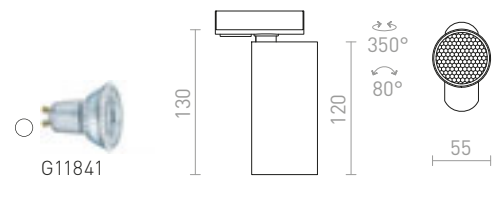

CADENZA

Foco cilíndrico com casquilho GU10 para calhas monofásicas.

CADENZA PARA CALHA MONOFÁSICA

230 V LED GU10 10 W

R13346 branco

€ 68

R13347 preto

€ 68

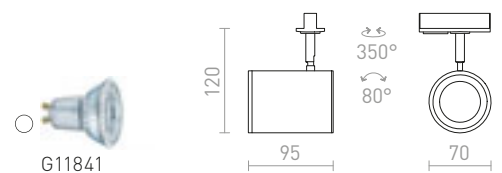



DARIO

Foco cilíndrico com casquilho GU10 para fontes de luz LED, incluindo um tom decorativo de latão preto escovado. Diferentes combinações de cores estão disponíveis comprando tons adicionais em outras cores. Para uso com calhas monofásicas.

DARIO PARA CALHA MONOFÁSICA

230 V GU10 9 W

R13870 branco/latão escovado

€ 78 NEW

R13871 preto/latão escovado

€ 78 NEW

R13872 latão escovado

€ 88 NEW

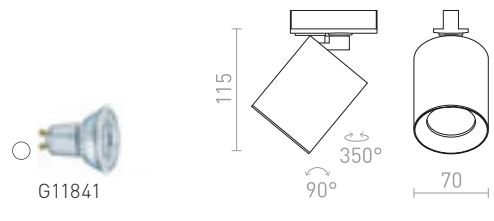
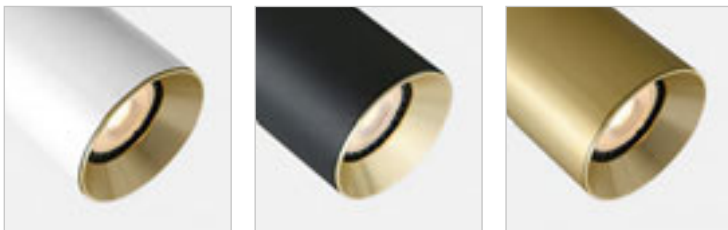

DARIO

Tonalidade decorativa interna de metal em várias cores para a luz DARIO.

DARIO ANEL DECORATIVO

R13876 branco

€ 9.80 NEW

R13877 preto

€ 9.80 NEW

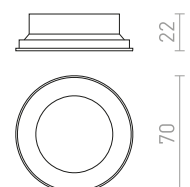
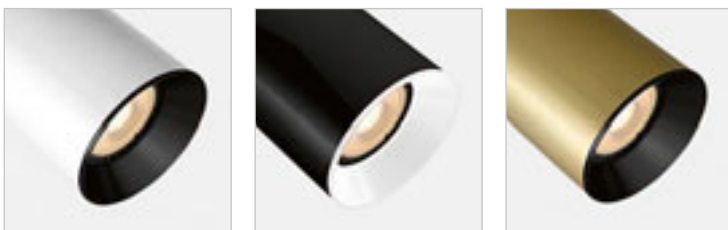



CONNOR

Foco cilíndrico com casquilho GU10 para calhas monofásicas.

CONNOR PARA CALHA MONOFÁSICA

230 V LED GU10 10 W

R13497 branco/preto

€ 68

R13498 preto/ouro

€ 68

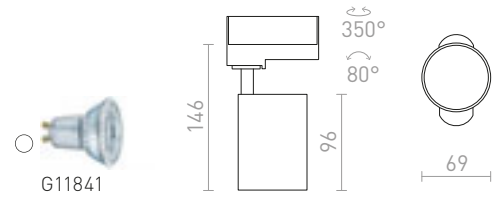

SIENA

Foco para calha monofásica disponível em duas cores para fontes de luz com casquilho GU10.

SIENA PARA CALHA MONOFÁSICA

230 V GU10 50 W

R13759 branco

€ 78

NEW

R13760 preto

€ 78

NEW

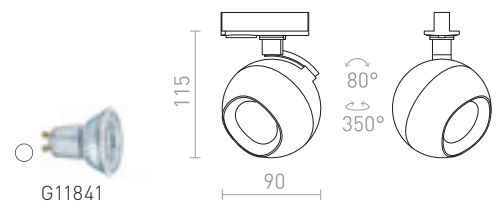

LALA

Foco cilíndrico para calha monofásica para fontes de luz com casquilho GU10.

LALA PARA CALHA MONOFÁSICA

230 V GU10 50 W

R13767 preto/latão

€ 68

NEW

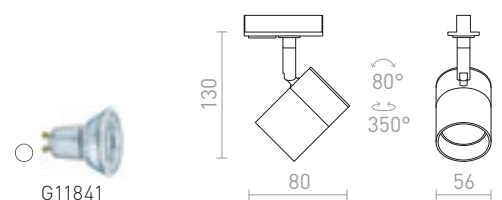



BEEBA

Foco para calhas monofásicas disponível em três cores.

BEEBA I PARA CALHA MONOFÁSICA

230 V GU10 35 W

R12308 branco

€ 58

R12309 cinzento prata

€ 58

R12310 preto

€ 58

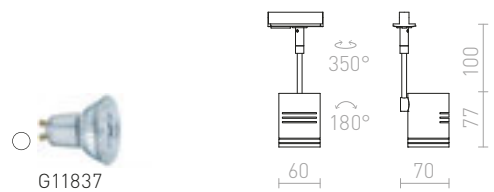

BEEBA II PARA CALHA MONOFÁSICA

230 V GU10 2x35 W

R12314 branco

€ 98

R12316 preto

€ 98

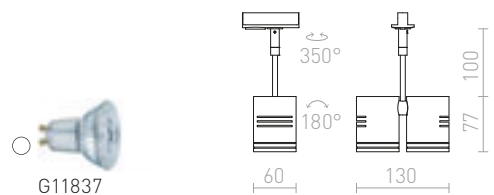



PURINA

Foco para calhas monofásicas com casquilho GU10 em três cores. Inclui um anel decorativo para fontes de luz com diâmetro de refletor de 51 mm. Fontes de luz ES111 também podem ser usadas nesta luminária.

PURINA PARA CALHA MONOFÁSICA

230 V GU10 50 W

R12320 branco	€ 48
R12321 cinzento prata	€ 48 %
R12322 preto	€ 48

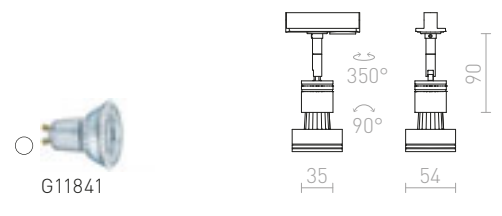

TRICA

Foco com casquilho GU10 para calhas monofásicas. Podem ser usadas fontes de luz com 111 e 51 mm de diâmetro. Todas as medidas são especificadas sem fonte de luz.

TRICA PARA CALHA MONOFÁSICA

230 V GU10 50 W

R12977 branco	€ 35
R12978 preto	€ 35

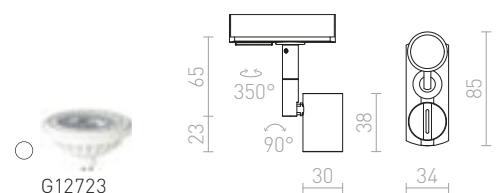



JULIETTA

Luminária suspensa com sombra cilíndrica cor opala, detalhes em metal lacado, cabo têxtil preto e adaptador para calhas monofásicas.

JULIETTA 16 PARA CALHA MONOFÁSICA

230 V E27 20 W

R13860 vidro colorido opala/preto

€ 88

NEW

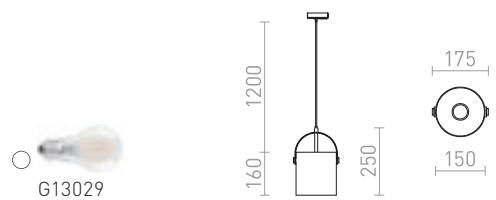

JULIETTA 31 PARA CALHA MONOFÁSICA

230 V E27 20 W

R13861 vidro colorido opala/preto

€ 120

NEW

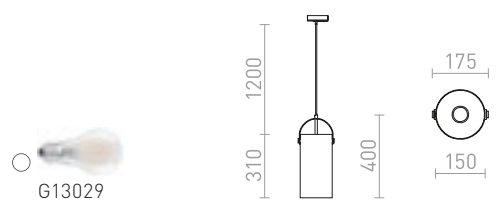



PULIRE

Candeeiro suspenso estilo retro feito em vidro tingido e com adaptador para calha monofásica.

PULIRE CON PARA CALHA MONOFÁSICA

230 V E14 28 W

R13209 vidro colorido opala/madeira

€ 120

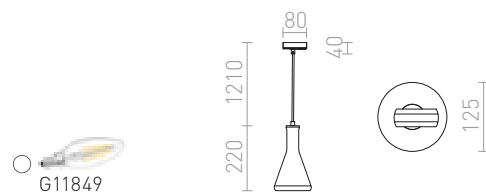

PULIRE RD PARA CALHA MONOFÁSICA

230 V E14 28 W

R13210 vidro colorido opala/madeira

€ 120

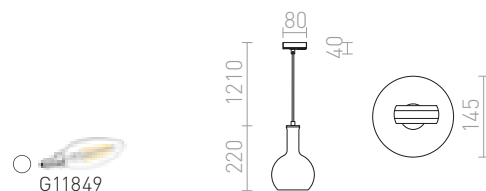



ICAR

Candeeiro suspenso minimalista com abajur têxtil. Cabo textil preto com adaptador para calha monofásica.

ICAR PARA CALHA MONOFÁSICA

230 V E27 15 W

R13214 preto/ouro

€ 120

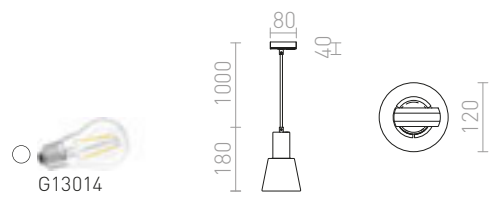

BABADES

Luminária suspensa com abajur e base de teto em cromo ou níquel mate. Cabo têxtil preto com adaptador para calhas monofásicas.

BABADES PARA CALHA MONOFÁSICA

230 V GU10 35 W

R13212 cromo

€ 78

R13213 níquel mate

€ 78

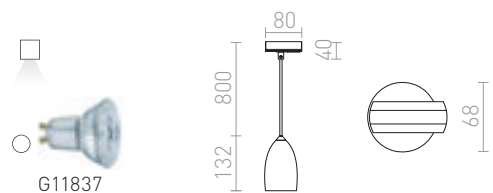



CHOUPETTE

Luminária suspensa em tecido com acessório em madeira para fonte de luz LED com casquinho E27 para instalação em calha monofásica.

CHOUPETTE PARA CALHA MONOFÁSICA

230 V E27 15 W

R13720 cinzento escuro/têxtil/madeira

€ 138

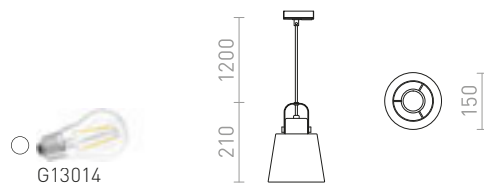

BELENOS

Luminária suspensa cilíndrica minimalista para fontes de luz GU10 numa base redonda. Molas presas à tomada permitem o uso de fontes de luz de vários comprimentos. O cabo é ligado a um adaptador para calhas monofásicas.

BELENOS SUSPENSAS PARA CALHA MONOFÁSICA

230 V LED GU10 9 W

R13862 branco

€ 68

NEW

R13863 preto

€ 68

NEW

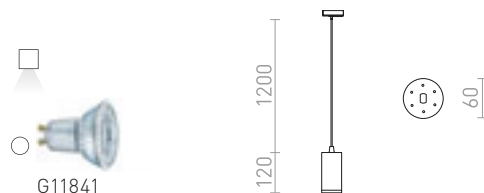



BLONDIE

Luminária suspensa com uma sombra de metal amassada. A parte externa da sombra é cor de cobre e a parte interna é lacada a branco. Fornecido com um cabo de PVC preto com adaptador para calhas monofásicas.

BLONDIE 25 PARA CALHA MONOFÁSICA

230 V E27 42 W

R13726 cobre

€ 215

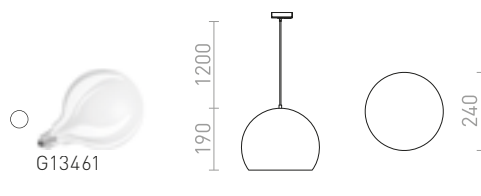

COPA

Luminária suspensa com abajur de vidro para calha monofásica. Disponível em duas cores.

COPA PARA CALHA MONOFÁSICA

230 V E27 28 W

R13205 vidro colorido opala

€ 178

R13206 preto/vidro

€ 188

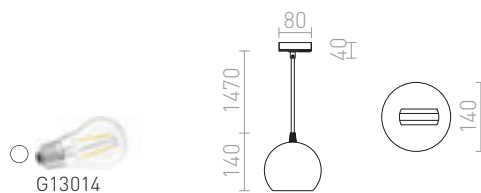



DESTY

Luminária suspensa com abajur metálico para calha monofásica.

DESTY PARA CALHA MONOFÁSICA

230 V GU10 35 W

R13211 preto/cromo

€ 98



G11837

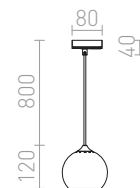

R13201

R13202

R13203

R13204

ELISA

Cabo têxtil em varias cores e combinações com casquilho metálico E27 e com adaptador para calha monofásica. Usar com fonte de luz decorativa ou com abajur disponível.

ELISA PARA CALHA MONOFÁSICA

230 V E27 28 W

R13201

€ 58

R13202

€ 58

R13203

€ 58

R13204

€ 58



G13461

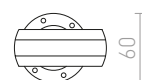
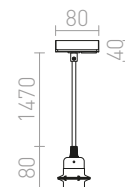

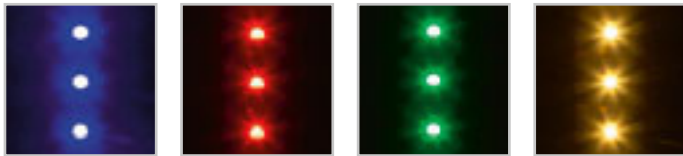

LED STRIP LED ORION

Fita de LED RGBW que pode ser configurada para cores diferentes ou branca com várias temperaturas de cor. Vem num comprimento de 5 m que pode ser cortado a cada 5 cm, e possui uma fita dupla face na parte de trás da fita. Driver e controlador de LED adequados precisam de ser adicionados e são vendidos separadamente. Recomendamos adquirir o nosso controlador G13804, que é testado e verificado e permite o controlo da faixa de LED por controlo remoto (incluído no pacote G13804), pelo uso do Amazon Alexa, Google Assistant ou com aplicativos como Smart Life e Tuya Smart.

LED STRIP ORION RGBW FITA LED 5M

12V LED 96W $\angle 120^\circ$ RGBW 4610 lm Ra 80

G13820

€ 58 **NEW**



LED

5000x12 mm

LED STRIP LED ORION

Fita de LED RGB com capacidade de mudar de cor que vem em comprimentos de 5m que podem ser cortados a cada cinco cm. A fita tem uma fita dupla face na parte de trás. Driver e controlador de LED adequados precisam de ser adicionados e são vendidos separadamente. Recomendamos adquirir o nosso controlador G13804, que é testado e verificado e permite o controlo da faixa de LED por controlo remoto (incluído no pacote G13804), pelo uso do Amazon Alexa, Google Assistant ou com aplicativos, tais como Smart Life e Tuya Smart.

LED STRIP ORION RGB FITA LED 5M

12V LED 72W $\angle 120^\circ$ RGB 2250 lm Ra 80

G13800

€ 38 **NEW**



LED

5000x10 mm



LED STRIP ORION CONTROLADOR WIFI 5 EM 1

Driver wi-fi 5 em 1. As fitas de LED podem ser controladas usando os aplicativos Amazon Alexa, Google Assistant ou Smart Life ou Tuya Smart. A unidade de controlo opera apenas na frequência de 2,4 GHz. O pack inclui um controlo remoto separado. O controlador Wi-fi pode ser usado para controlar as fitas de LED RGB ou escurecer as fitas de LED monocromáticas G13798, G13799.

G13804

€ 26 **NEW**



LED STRIP ORION 60 DRIVER

Driver LED 60W 12V para alimentar fitas de LED.

12 V/230V 60 W

G13801

€ 24

NEW



25x202x35 mm



LED STRIP ORION 100 DRIVER

Driver LED 100W 12V para alimentar fitas de LED.

12 V/230V 100 W

G13802

€ 32

NEW



35x178x53 mm



LED STRIP ORION 150 DRIVER

Driver LED 150W 12V para alimentar fitas de LED.
O driver possui terminais secundários.

12 V/230V 150 W

G13803

€ 48

NEW



33x199x61 mm



LED STRIP LED ORION

Fita LED COB com alto rendimento. A fita tem uma luz uniforme em toda a sua extensão, sem manchas visíveis. Fornecido em comprimentos de 5m que podem ser cortados a cada 0,75 cm e possui fita dupla face na parte de trás. O driver adequado precisa de ser adicionado e é vendido separadamente. A faixa pode ser regulada usando o controlo remoto G13804.

LED STRIP ORION FITA LED 5M

12V LED 50 W $\angle 120^\circ$ 3000 K 4750 lm Ra 80

G13798

€ 58

NEW



5000x8 mm

LED STRIP ORION FITA LED 5M

12V LED 50 W $\angle 120^\circ$ 4000 K 5000 lm Ra 80

G13799

€ 58

NEW



5000x8 mm

LED STRIP ORION CONTROLADOR WIFI 5 EM 1

Driver wi-fi 5 em 1. As fitas de LED podem ser controladas usando os aplicativos Amazon Alexa, Google Assistant ou Smart Life ou Tuya Smart. A unidade de controlo opera apenas na frequência de 2,4 GHz. O pack inclui um controlo remoto separado. O controlador Wi-fi pode ser usado para controlar as fitas de LED RGB ou escurecer as fitas de LED monocromáticas G13798, G13799.

G13804

€ 26

NEW



LED STRIP ORION 60 DRIVER

Driver LED 60W 12V para alimentar fitas de LED.

12 V/230V 60 W

G13801

€ 24

NEW



25x202x35 mm



LED STRIP ORION 100 DRIVER

Driver LED 100W 12V para alimentar fitas de LED.

12 V/230V 100 W

G13802

€ 32

NEW



35x178x53 mm



LED STRIP ORION 150 DRIVER

Driver LED 150W 12V para alimentar fitas de LED.
O driver possui terminais secundários.

12 V/230V 150 W

G13803

€ 48

NEW



33x199x61 mm



LED STRIP IP20 5M

Fita LED adequada para iluminação interior decorativa. Fornecida em embalagem de 5 metros, divisível a cada 5 cm, com uma fita adesiva com nervuras nas costas. A fita está disponível em versões de luz quente ou fria. Precisa de um driver e conector (vendidos separadamente).

12 V= LED 60 W 5000 lm Ra 80

G12366 3000 K

€ 15.50

G12367 4000 K

€ 15.50



G12376



5000x8 mm



LED STRIP IP20 FONTE DE ENERGIA

Acessórios para LED STRIP IP20 G12366 e G12367.

G12370

€ 0.50



150 mm

LED STRIP IP20 LIGAÇÃO

Acessórios para LED STRIP IP20 G12366 e G12367.

G12368

€ 0.80



165 mm

LED STRIP IP20 LIGAÇÃO DIRETA

Acessórios para LED STRIP IP20 G12366 e G12367.

G12369

€ 0.40



5x16x13 mm

LED STRIP FONTE DE ENERGIA

Fonte de alimentação para fitas LED 12V =, 230 V/12V= 30 W

G12376

€ 15.50



33x60x85 mm

LED STRIP FONTE DE ENERGIA

Fonte de alimentação para fitas LED 12V =, 230 V/12V= 72 W

G12377

€ 22



42x100x160 mm



LED STRIP IP54 5M

Fita LED adequada para iluminação decorativa em ambientes húmidos. Fornecida em uma embalagem de 5 metros, divisível a cada 5 cm, com uma fita adesiva com nervuras nas costas. A fita está disponível em versões de luz quente ou fria. Precisa de um driver e conetor.

12V= LED 60 W 5000 lm Ra 80 IP54

G12371 3000 K € 22
G12372 4000 K € 22



G12376



5000x8 mm

LED STRIP IP54 FONTE DE ENERGIA

Acessórios para LED STRIP IP54 G12371 e G12372.

G12375 € 0.70



150 mm

LED STRIP IP54 LIGAÇÃO

Acessórios para LED STRIP IP54 G12371 e G12372.

G12373 € 1.20



165 mm

LED STRIP IP54 LIGAÇÃO DIRETA

Acessórios para LED STRIP IP54 G12371 e G12372.

G12374 € 0.50



8x15x14 mm

IP54

LED STRIP REGULADOR DA INTENSIDADE DA LUZ COM CONTROLO REMOTO

Controlo remoto para fita LED 12V = intensidade de luz ajustável. Adequado para fitas LED G12366, G12367, G12371 ou G12372.

12V= max 108 W

G12378 branco € 48



G12376



103x54x6 mm



LED PROFIL

Perfil de alumínio para uso com fita de LED adequada. Inclui um difusor fosco e acessórios.

LED PROFILE A EMBUTIDA 1M

R13864 alumínio/acrílico fosco

€ 32 **NEW**

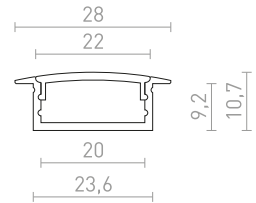

↑ 9
 1000x24



LED PROFIL

Perfil de alumínio para uso com fita de LED adequada. Inclui um difusor fosco e acessórios. Adequado para embutir na parede de gesso.

LED PROFILE B EMBUTIDA 1M

R13865 alumínio/acrílico fosco

€ 58 **NEW**

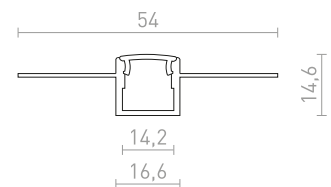

↑ 14
 1000x17





LED PROFIL

Perfil de alumínio para uso com fita de LED adequada. Inclui um difusor fosco e acessórios.

LED PROFILE D MONTAGEM EM SUPERFÍCIE 1M

R13866 alumínio/acrílico fosco

€ 38

NEW

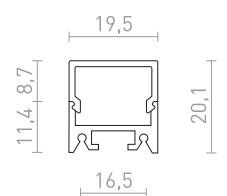



LED PROFIL

Perfil de alumínio para uso com fitas LED adequadas. Fornevido com um difusor fosco e acessórios correspondentes.

LED PROFILE E DE SUPERFÍCIE 1M

R13385

€ 19 %

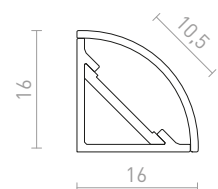



LED PROFIL

Perfil de alumínio para uso com fitas LED adequadas. Fornecido com um difusor fosco e acessórios correspondentes.

LED PROFILE F DE SUPERFÍCIE 1M

R13386

€ 28 %

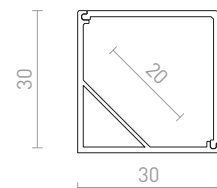

LED PROFIL

Perfil de alumínio para uso com fitas LED adequadas. Fornecido com um difusor fosco e acessórios correspondentes.

LED PROFILE C MONTADO EM SUPERFÍCIE 1M

R13383

€ 19.50 ➔

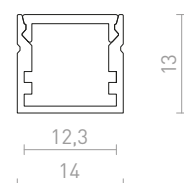



ABAJURES E ACESSÓRIOS

ABAJURES SUSPENSOS	568-571
ABAJURES DE MESA/DE PÉ	572-575
ABAJURES UNIVERSAIS	576-591
CONJUNTO DE SUSPENSÃO	592-605
SUPORTES E BASES	606-615
CABOS	616-617



ABAJURES E ACESSÓRIOS ABAJURES SUSPENSOS



DAISY
568-569



BEAT 38
568-569



STAMPATA 35/28
568-569

568-571



ASPRO 40/30
570-571



ASPRO 55/30
570-571



KARO 55/15
570-571

ABAJURES E ACESSÓRIOS ABAJURES DE MESA/DE PÉ



CONNYY 35/30
572-573



CONNYY 15/15
572-573



CONNYY 25/30
572-573

572-575



CONNYY 15/30
572-573



ALVIS 24/15
574-575



AMBITUS 46/24
574-575



NIZZA 18/15
574-575



AMBITUS 30/21
574-575

ABAJURES E ACESSÓRIOS ABAJURES UNIVERSAIS



RIDICK
576-577



ILLUSION 45/33
576-577



JAKARANDA 40
576-577

576-591



DELISA 25/16
578-579



DELISA 35/30
578-579



DELI 55/30
578-579



RON 60/19
580-581



RON 55/30
580-581



RON 40/25
582-583



RON 15/20
582-583



DOUBLE 40/30
584-585



DOUBLE 55/30
584-585



TEMPO 30/19
586-587



TEMPO 50/19
586-587



TEMPO 15/30
588-589



TEMPO 15/15
588-589



CASUAL 120/25
588-589



CASUAL 90/22
588-589



LOPE 80/23
590-591



LOPE 120/22
590-591

ABAJURES E ACESSÓRIOS CONJUNTO DE SUSPENSÃO



MORE 60, 80
592-593



RALLONG IV
592-593



RALLONG IV
592-593

592-605



RALLONG V
592-593



RALLONG V
592-593



KOMBIX 2
594-595



KOMBIX 3
594-595



KOMBIX 6
594-595



HEX
596-597



ELISA
598-599



FABIO
600-601



LISA
600-601



ENZO
600-601



SOLO SQ
602-603



SOLO R
602-603



POSTE
602-603



TRIX
602-603



SPIDER I
604-605

ABAJURES E ACESSÓRIOS SUPORTES E BASES

606-615



BEND
606-607



HUDSON
606-607



NIZZA 18/15
608-609



NIZZA
608-609



WOODY
608-609



AMBITUS
610-611



AMBITUS
610-611



ALVIS
610-611



ALVIS
610-611



KEITH
612-613



MAUI
612-613



LUTON
612-613



NYC TRIPOD
612-613



NYC
614-615



NYC
614-615



CORTINA
614-615



CORTINA
614-615

ABAJURES E ACESSÓRIOS CABOS

616-617



FIT 3x0,75 4m
616-617



FIT 3x0,75
616-617

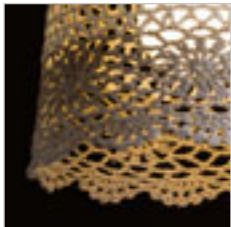
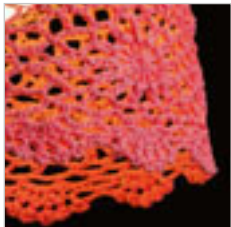
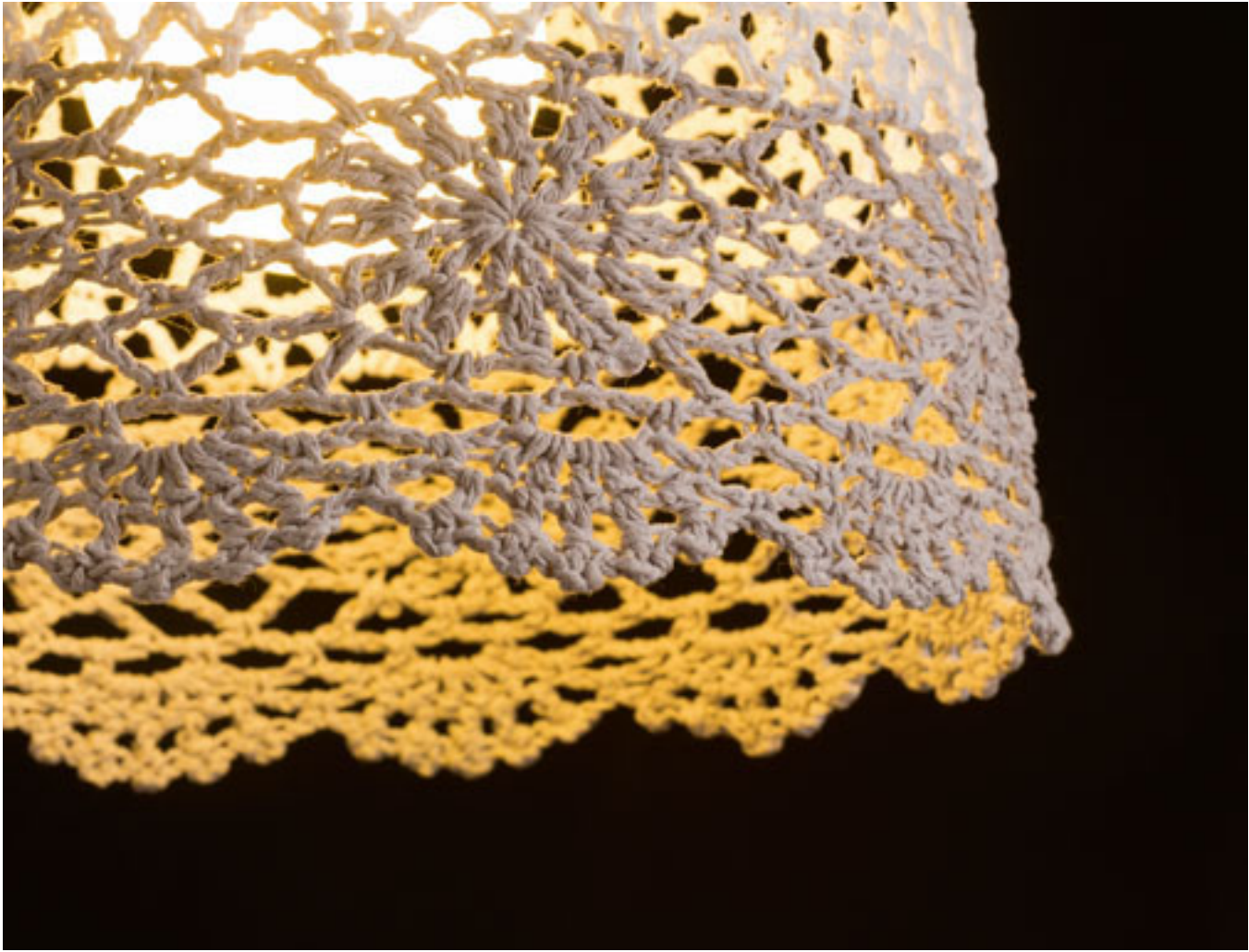

DAISY

Abajur suspenso de malha.

DAISY ABAJUR SUSPENSO

max. 15 W

R13278 rosa

€ 28 %

R13279 branco/cinza claro

€ 28 %





BEAT

Abajur acolchoado sólido de imitação de couro.

BEAT 38 ABAJUR SUSPENSO

max 28 W

R13281 preto

€ 48 %

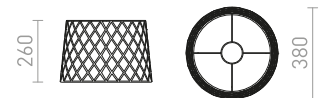

STAMPATA

Abajur para candeeiros suspensos.

STAMPATA 35/28 ABAJUR

max 15 W

R13448 branco creme/papel

€ 14 %





ASPRO

Abajur têtil para casquilho E27. Adequado para instalação em conjunto de suspensão. O difusor PMMA (R11867) pode ser encomendado para o abajur. Acessórios adequados: HEX, ELISA, ENZO, KOMBIX, LISA, POSTE, TRIX.

ASPRO 40/30 ABAJUR

max 23 W

	R11467 Poli-algodão preto/folha dourada	€ 188
	R11483 Poli-algodão preto/folha de cobre	€ 188
	R11495 Poli-algodão branco/PVC branco	€ 120
	R11578 monaco gasolina azul/prata PVC	€ 198
	R11589 monaco pomba gris/prata PVC	€ 198

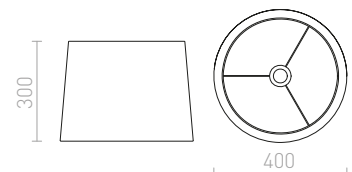



KARO

Abajur têxtil para casquilho E27, adequado para instalação em conjuntos de suspensão. Acessórios adequados: HEX, ELISA, ENZO, LISA, POSTE, TRIX.

KARO 55/15 ABAJUR

max 23 W

	R11470 Poli-algodão preto/folha dourada	€ 220
	R11499 Poli-algodão branco/PVC branco	€ 150

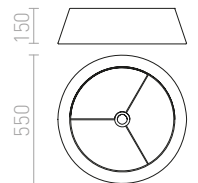
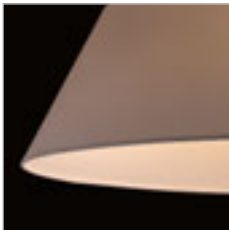

ASPRO

Abajur têxtil para casquilho E27. Adequado para uso com conjunto de suspensão. O difusor PMMA (R11867) pode ser encomendado para o abajur. Adequado para acessórios: HEX, ELISA, ENZO, KOMBIX, LISA, POSTE, TRIX.

ASPRO 55/30 ABAJUR

max 23 W

	R11466 Poli-algodão preto/folha dourada	€ 238
	R11482 Poli-algodão preto/folha de cobre	€ 238
	R11494 Poli-algodão branco/PVC branco	€ 120
	R11577 monaco gasolina azul/prata PVC	€ 238
	R11588 monaco pomba gris/prata PVC	€ 238

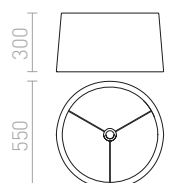



CONNY

Abajur têxtil para uso com candeeiros de mesa com casquilho E27. Acessórios adequados: CORTINA, NYC, NYC TRIPOD, WOODY.

CONNY 25/30 ABAJURES DE MESA

max. 23 W

	R11371 Poli-algodão preto/folha de cobre	€ 138
	R11497 Poli-algodão branco/PVC branco	€ 78
	R11580 monaco gasolina azul/prata PVC	€ 129
	R11591 monaco pomba gris/prata PVC	€ 129
	R11597 Poli-algodão preto/folha dourada	€ 120

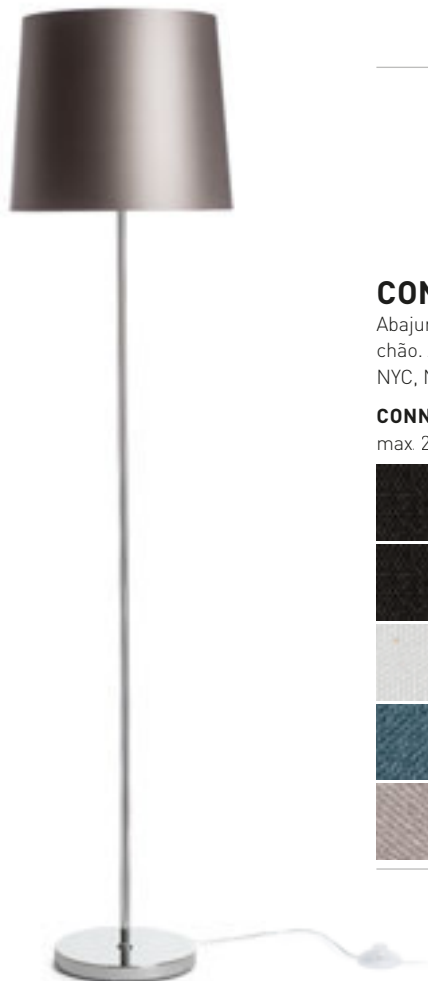
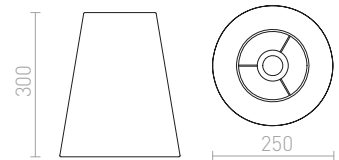

CONNY

Abajur têxtil para casquilho E27 para vários suportes de chão. Acessórios adequados: ALVIS, AMBITUS, CORTINA, NYC, NYC TRIPOD, WOODY.

CONNY 35/30 ABAJUR

max. 23 W

	R11372 Poli-algodão preto/folha de cobre	€ 178
	R11469 Poli-algodão preto/folha dourada	€ 178
	R11498 Poli-algodão branco/PVC branco	€ 98
	R11581 monaco gasolina azul/prata PVC	€ 178
	R11592 monaco pomba gris/prata PVC	€ 178

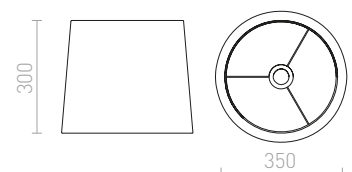



CONNY

Abajur têxtil para casquilho E27. Adequado para uso com suporte de candeeiro de mesa. Acessórios adequados: ALVIS, AMBITUS, CORTINA, NYC.

CONNY 15/15 ABAJUR

max 28 W

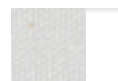

R11800
Poli-algodão branco/PVC branco

€ 68

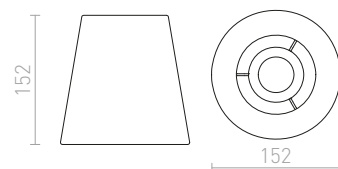

CONNY

Abajur têxtil para uso com candeeiros de mesa E27. Acessórios adequados: CORTINA, NYC.

CONNY 15/30 ABAJURES DE MESA

max 23 W



R11370
Poli-algodão preto/folha de cobre

€ 98



R11468
Poli-algodão preto/folha dourada

€ 88

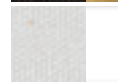

R11496
Poli-algodão branco/PVC branco

€ 58



R11579
monaco gasolina azul/prata PVC

€ 88



R11590
monaco pomba gris/prata PVC

€ 88

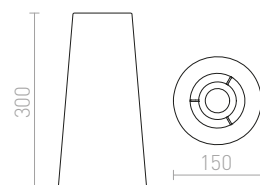



AMBITUS

Abajur têxtil com suporte para casquilho E27, adequado para bases de candeeiros de mesa: ALVIS, AMBITUS, CORTINA, MAUI, NYC, WOODY.

AMBITUS 30/21 ABAJUR DE MESA
max. 28 W

R13841 branco creme

€ 68 NEW

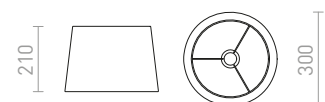



NIZZA

Abajur têxtil para casquilho E27, adequado para instalação em conjuntos suspensos e candeeiros de mesa R12947.

NIZZA 18/15 ABAJUR

max 28 W

R13113 Poli-algodão branco/PVC branco

€ 58

R13114 Poli-algodão preto/PVC branco

€ 58

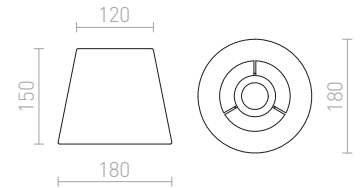

ALVIS

Abajur têxtil para casquilho E27. Adequado para suportes de candeeiro de mesa: ALVIS, CORTINA, MAUI, NYC, MADEIRA.

ALVIS 24/15 ABAJUR CANDEEIRO DE MESA

max 28 W

R13524 branco creme

€ 38

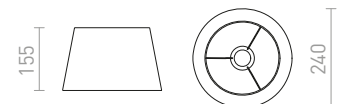

AMBITUS

Abajur têxtil com suporte para casquilho E27, adequado para bases de candeeiros de pé: ALVIS, AMBITUS, CORTINA, MAUI, NYC.

AMBITUS 46/24 ABAJUR CANDEEIRO DE PÉ

max 28 W

R13526 branco creme

€ 78

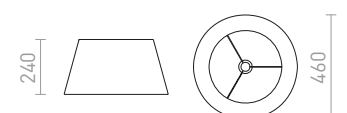



RIDICK

Abajur decorativo preto com interior dourado, que pode ser combinado com um conjunto suspenso ou uma luminária de pé. Acessórios adequados: HEX, ELISA, ENZO, LISA, KOMBIX, BEND, ALVIS, AMBITUS, NYC.

RIDICK ABAJUR

max. 20 W

R13344 preto brilhante/folha dourada

€ 58

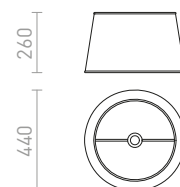

ILLUSION

Abajur decorativo de folha de cromo, que pode ser combinado com um conjunto suspenso ou uma base de candeeiro de pé. Quando a lâmpada está acesa, ela se torna semi-transparente e, quando desligada, possui uma superfície refletora. Acessórios adequados: HEX, ELISA, ENZO, LISA, KOMBIX, BEND, ALVIS, AMBITUS, NYC.

ILLUSION 45/33 ABAJUR

max. 20 W

R13417 folha de cromo

€ 98

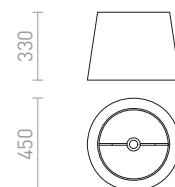

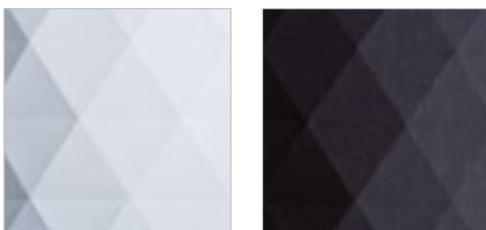

JAKARANDA

Abajur têtil com a superfície 3D geométrica. Para uso com um conjunto suspenso ou um suporte para casquilho E27. Acessórios adequados: HEX, ELISA, ENZO, KOMBIX, LISA, AMBITUS, ALVIS, CORTINA.

JAKARANDA 40 ABAJUR

max 28 W

R12392 branco

€ 129

R12393 preto

€ 129

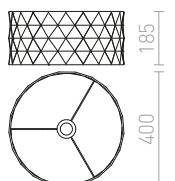



DELI

Abajur decorativo com botões coloridos adequados para suspensão ou suportes. Acessórios adequados: HEX, ELISA, ENZO, LISA, POSTE, TRIX, KOMBIX.

DELI 55/30 ABAJUR

max. 28 W

R12391 branco/botões

€ 120 ➔

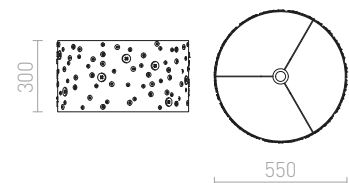



DELISA

Abajur decorativo com botões coloridos adequados para suspensão ou bancada. Acessórios adequados: HEX, ELISA, ENZO, KOMBIX, LISA, AMBITUS, ALVIS, CORTINA.

DELISA 25/16 ABAJUR

max 28 W

R12388 branco/botões

€ 32 ➔

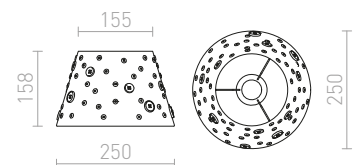

DELISA

Abajur decorativo com botões coloridos adequados para suspensão ou suportes. Acessórios adequados: HEX, ELISA, ENZO, LISA, KOMBIX, AMBITUS, ALVIS, CORTINA.

DELISA 35/30 ABAJUR

max 28 W

R12389 branco/botões

€ 68 ➔

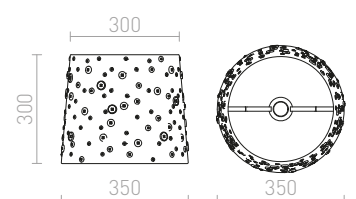



DIFFUSER

Difusor circular para abajures têxteis.

DIFFUSER R 60 PMMA

G11869 acrílico fosco

€ 35



RON

Abajur têxtil para casquilho E27. Instalação em base de teto ou conjunto de suspensão. O difusor PMMA (R11869, R12301) pode ser encomendado para o abajur, mas não é adequado para R11452. Acessórios adequados: HEX, ELISA, ENZO, LISA, POSTE, TRIX.

RON 60/19 ABAJUR

max 23 W

	R11462 Poli-algodão preto/folha dourada	€ 188
	R11479 Poli-algodão preto/folha de cobre	€ 188
	R11490 Poli-algodão branco/PVC branco	€ 120
	R11517 Chintz laranja/PVC branco	€ 98
	R11546 Chintz menta/folha de prata	€ 178
	R11555 Chintz cinza claro/PVC branco	€ 98
	R11565 Chintz limão/PVC branco	€ 98
	R11573 monaco gasolina azul/prata PVC	€ 178
	R11584 monaco pomba gris/prata PVC	€ 178
	R11607 Alperce de Chintz/PVC branco	€ 98
	R13052 Poli-algodão preto/PVC branco	€ 120

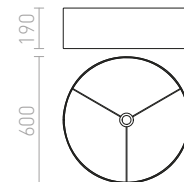



DIFFUSER

Difusor circular para abajures têxteis.

DIFFUSER R 55 PMMA

G11868 acrílico fosco

€ 32

G12300 claro

€ 32



RON

Abajur têxtil para casquilho E27. O abajur pode ser usado em base de teto, ou conjunto suspenso ou suporte como: HEX, ELISA, ENZO, LISA, POSTE, TRIX, IRIDIS, KOMBIX. O difusor PMMA (R11868, R12300) pode ser encomendado para o abajur.

RON 55/30 ABAJUR

max. 23 W

	R11463 Poli-algodão preto/folha dourada	€ 215
	R11480 Poli-algodão preto/folha de cobre	€ 215
	R11491 Poli-algodão branco/PVC branco	€ 120
	R11518 Chintz laranja/PVC branco	€ 120
	R11547 Chintz menta/folha de prata	€ 150 %
	R11556 Chintz cinza claro/PVC branco	€ 120
	R11566 Chintz limão/PVC branco	€ 120
	R11574 monaco gasolina azul/prata PVC	€ 198
	R11585 monaco pomba gris/prata PVC	€ 198
	R11608 Alperce de Chintz/PVC branco	€ 120
	R13051 Poli-algodão preto/PVC branco	€ 129

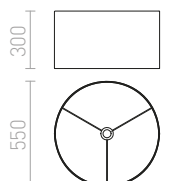



DIFFUSER

Difusor circular para abajures têxteis.

DIFFUSER R 40 PMMA

G11867 acrílico fosco

€ 19.50

G12299 claro

€ 19.50



RON

Abajur têxtil para casquilho E27. Instalação em teto, conjunto de suspensão ou suportes. O difusor PMMA (R11867, R12299) pode ser encomendado para o abajur, mas não é adequado para R11455. Acessórios adequados: HEX, ELISA, ENZO, KOMBIX, LISA, KOMBIX, AMBITUS, ALVIS, CORTINA, NYC, NYC TRIPOD, WOODY.

RON 40/25 ABAJUR

max 23 W

	R11455 rosa plissado	€ 32 %
	R11465 Poli-algodão preto/folha dourada	€ 150
	R11481 Poli-algodão preto/folha de cobre	€ 158
	R11493 Poli-algodão branco/PVC branco	€ 88
	R11510 Alperce de Chintz/PVC branco	€ 88
	R11520 Chintz laranja/PVC branco	€ 88
	R11540 Chintz azeitona/folha de prata	€ 88 %
	R11549 Chintz menta/folha de prata	€ 150
	R11558 Chintz cinza claro/PVC branco	€ 88
	R11568 Chintz limão/PVC branco	€ 88
	R11576 monaco gasolina azul/prata PVC	€ 150
	R11587 monaco pomba gris/prata PVC	€ 150
	R13050 Poli-algodão preto/PVC branco	€ 88

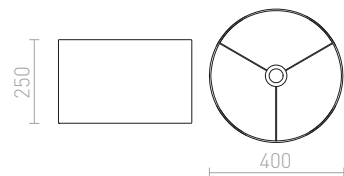



RON

Abajur têxtil para casquilho E27 adequado para instalação em conjuntos suspensos ou suportes de mesa como: HEX, ELISA, ENZO, KOMBIX, LISA, MAIS, CORTINA, NYC.

RON 15/20 ABAJUR

max. 28 W

	R11802 Poli-algodão preto/folha dourada	€ 98
	R11803 Poli-algodão preto/folha de cobre	€ 98
	R11804 Poli-algodão branco/PVC branco	€ 68
	R11805 Alperce de Chintz/PVC branco	€ 68
	R11806 Chintz laranja/PVC branco	€ 68
	R11809 Chintz limão/PVC branco	€ 68
	R11810 monaco pomba gris/prata PVC	€ 98
	R11811 monaco gasolina azul/prata PVC	€ 98
	R13049 Poli-algodão preto/PVC branco	€ 68

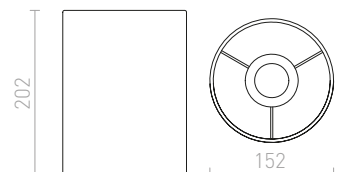



DIFFUSER

Difusor circular para abajures têxteis.

DIFFUSER R 55 PMMA

G11868 acrílico fosco

€ 32

G12300 claro

€ 32



DOUBLE

Abajur têxtil para casquilho E27. Instalação no teto ou conjunto de suspensão. Um difusor PMMA (R11868, R12300) pode ser encomendado para o abajur. Acessórios adequados: HEX, ELISA, ENZO, KOMBIX, LISA, POSTE, TRIX.

DOUBLE 55/30 ABAJUR

max 23 W

	R11477 Poli-algodão preto/folha dourada	€ 215
	R11478 Poli-algodão preto/folha de cobre	€ 229
	R11508 Alperce de Chintz/PVC branco	€ 129
	R11516 Chintz laranja/PVC branco	€ 129
	R11545 Chintz menta/folha de prata	€ 215
	R11554 Chintz cinza claro/PVC branco	€ 129
	R11564 Chintz limão/PVC branco	€ 129
	R11600 Poli-algodão branco/PVC branco	€ 138

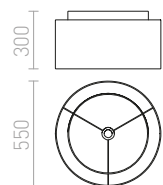



DIFFUSER

Difusor circular para abajures têxteis.

DIFFUSER R 40 PMMA

G11867 acrílico fosco

€ 19.50

G12299 claro

€ 19.50



DOUBLE

Abajur têxtil para casquilho E27. Instalação no teto ou em conjunto de suspensão. O difusor PMMA (R11867, R12299) pode ser encomendado para o abajur. Acessórios adequados: HEX, ELISA, ENZO, KOMBIX, LISA.

DOUBLE 40/30 ABAJUR

max 23 W

	R11461 Poli-algodão preto/folha dourada	€ 188
	R11507 Alperce de Chintz/PVC branco	€ 120
	R11515 Chintz laranja/PVC branco	€ 120
	R11535 Chintz azeitona/folha de prata	€ 120 %
	R11544 Chintz menta/folha de prata	€ 215
	R11553 Chintz cinza claro/PVC branco	€ 120
	R11563 Chintz limão/PVC branco	€ 120
	R11599 Poli-algodão branco/PVC branco	€ 120

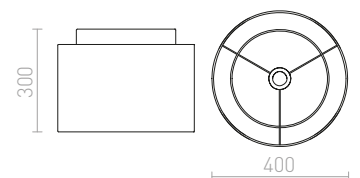



DIFFUSER

Difusor quadrado para abajures têxteis.

DIFFUSER SQ 50 PMMA

G11871 acrílico fosco

€ 32

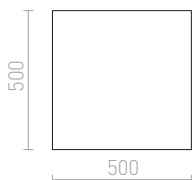

TEMPO

Abajur têxtil para casquilho E27 a ser instalado em uma base de teto ou conjunto de suspensão. O difusor PMMA (R11871) pode ser encomendado para o abajur. Acessórios adequados: HEX, ELISA, ENZO, KOMBIX, LISA, NYC.

TEMPO 50/19 ABAJUR

max 23 W

	R11475 Poli-algodão preto/folha dourada	€ 188
	R11488 Poli-algodão preto/folha de cobre	€ 188
	R11505 Poli-algodão branco/PVC branco	€ 120
	R11513 Alperce de Chintz/PVC branco	€ 68 %
	R11523 Chintz laranja/PVC branco	€ 68 %
	R11542 Chintz azeitona/folha de prata	€ 88 %
	R11551 Chintz menta/folha de prata	€ 88 %
	R11561 Chintz cinza claro/PVC branco	€ 68 %

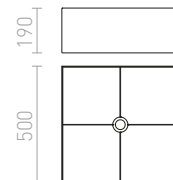



DIFFUSER

Difusor quadrado para abajures têxteis.

DIFFUSER SQ 30 PMMA

G11870 acrílico fosco

€ 18

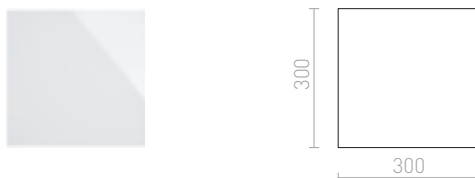

TEMPO

Abajur têxtil para casquilho E27 para instalação em base de teto, conjunto de suspensão ou base de suporte. Um difusor PMMA (R11870) pode ser encomendado para o abajur. Acessórios adequados: SOLO, HEX, ELISA, ENZO, KOMBIX, LISA, NYC.

TEMPO 30/19 ABAJUR

max. 23 W

	R11476 Poli-algodão preto/folha dourada	€ 120
	R11489 Poli-algodão preto/folha de cobre	€ 138
	R11506 Poli-algodão branco/PVC branco	€ 88
	R11514 Alperce de Chintz/PVC branco	€ 48 %
	R11524 Chintz laranja/PVC branco	€ 48 %
	R11543 Chintz azeitona/folha de prata	€ 58 %
	R11552 Chintz menta/folha de prata	€ 58 %
	R11562 Chintz cinza claro/PVC branco	€ 48 %

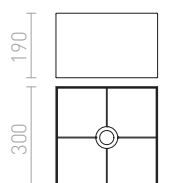



TEMPO

Abajur têxtil para casquilho E27. Adequado para instalação em conjuntos suspensos ou suportes de mesa, por exemplo: HEX, ELISA, ENZO, KOMBIX, LISA, MAIS, NYC

TEMPO 15/30 ABAJUR

max 28 W

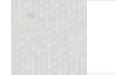

R11822

Poli-algodão branco/PVC branco

€ 78

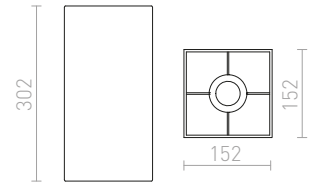

TEMPO

Abajur têxtil para casquilho E27, adequado para instalação em conjuntos suspensos ou suportes de mesa, por exemplo: HEX, ELISA, ENZO, KOMBIX, LISA, MAIS, NYC

TEMPO 15/15 ABAJUR

max 28 W



R11812

Poli-algodão preto/folha dourada

€ 98



R11813

Poli-algodão preto/folha de cobre

€ 98



R11814

Poli-algodão branco/PVC branco

€ 68



R11815

Alperce de Chintz/PVC branco

€ 68



R11816

Chintz laranja/PVC branco

€ 68



R11817

Chintz terracota/PVC branco

€ 48 →



R11819

Chintz limão/PVC branco

€ 68



R11820

monaco gasolina azul/prata PVC

€ 98

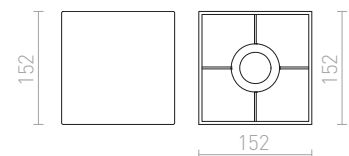



CASUAL

Abajur têxtil para instalação na base do teto R11797 ou conjunto suspenso R11798.

CASUAL 120/25 ABAJUR

max 23 W

	R11471 Poli-algodão preto/folha dourada	€ 320
	R11484 Poli-algodão preto/folha de cobre	€ 345
	R11500 Poli-algodão branco/PVC branco	€ 188
	R11582 monaco gasolina azul/prata PVC	€ 290
	R11593 monaco pomba gris/prata PVC	€ 290

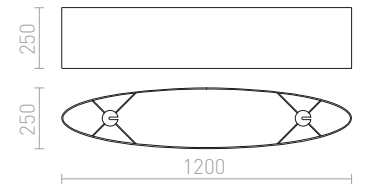

CASUAL

Abajur têxtil para instalação na base do teto R11795 ou conjunto suspenso R11796.

CASUAL 90/22 ABAJUR

max 23 W

	R11472 Poli-algodão preto/folha dourada	€ 258
	R11485 Poli-algodão preto/folha de cobre	€ 268
	R11501 Poli-algodão branco/PVC branco	€ 178
	R11583 monaco gasolina azul/prata PVC	€ 248
	R11594 monaco pomba gris/prata PVC	€ 248

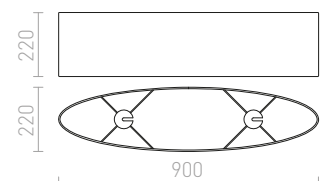



LOPE

Abajur têxtil adequado para instalação na base do candeeiro de teto R11797 ou no conjunto suspenso R11798.

LOPE 120/22 ABAJUR

max. 23 W

	R11473 Poli-algodão preto/folha dourada	€ 320
	R11486 Poli-algodão preto/folha de cobre	€ 320
	R11502 Poli-algodão branco/PVC branco	€ 178
	R11611 Alperce de Chintz/PVC branco	€ 98 %
	R11616 Chintz laranja/PVC branco	€ 98 %
	R11634 Chintz cinza claro/PVC branco	€ 98 %
	R11639 Chintz limão/PVC branco	€ 98 %

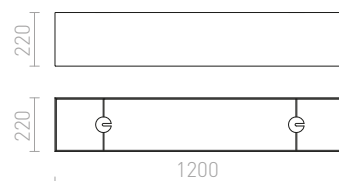



LOPE

Abajur têxtil adequado para instalação na base do candeeiro de teto R11795 ou no conjunto suspenso R11796.

LOPE 80/23 ABAJUR

max 23 W

	R11474 Poli-algodão preto/folha dourada	€ 198
	R11487 Poli-algodão preto/folha de cobre	€ 120 %
	R11503 Poli-algodão branco/PVC branco	€ 138
	R11511 Alperce de Chintz/PVC branco	€ 58 %
	R11541 Chintz azeitona/folha de prata	€ 120 %
	R11550 Chintz menta/folha de prata	€ 120 %
	R11559 Chintz cinza claro/PVC branco	€ 58 %
	R11569 Chintz limão/PVC branco	€ 58 %

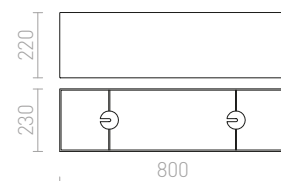



MORE

Base linear de teto em acabamento brilhante e mate de 60 ou 80 cm para a suspensão de três abajures. Adequada para abajures: RON 15/20, TEMPO 15/15, TEMPO 15/30.

MORE 80 BASE PARA TETO SUSPENSO

230 V E27 3x42 W

R11776 níquel mate

€ 58

%

R11777 cromo

€ 58

%

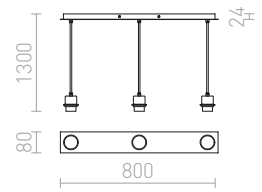

MORE 60 BASE PARA TETO SUSPENSO

230 V E27 3x42 W

R11774 níquel mate

€ 48

%

R11775 cromo

€ 48

%

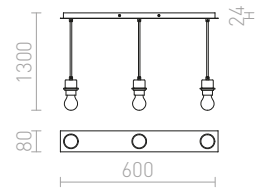



RALLONG

Conjunto suspenso para abajures têxteis oblongos. RALLONG 4 pode ser combinado com os abajures CASUAL 90 e LOPE 80. RALLONG 5 pode ser combinado com os abajures CASUAL 120 e LOPE 120.

RALLONG IV BASE PARA TETO SUSPENSO

230 V E27 4x42 W

R11796 cromo

€ 78

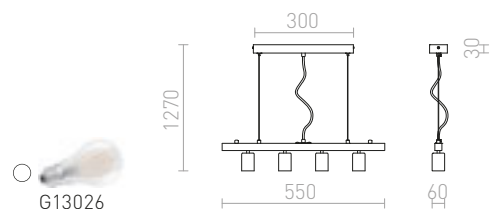

RALLONG V BASE PARA TETO SUSPENSO

230 V E27 5x42 W

R11798 cromo

€ 120

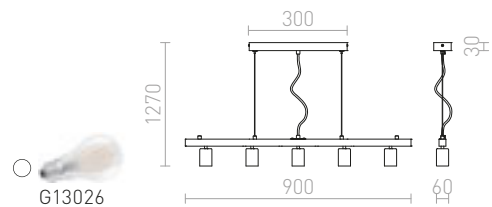

RALLONG IV BASE PARA TETO

230 V E27 4x42 W

R11795 cromo

€ 35

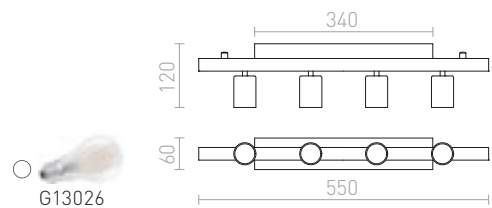

RALLONG V BASE PARA TETO

230 V E27 5x42 W

R11797 cromo

€ 78

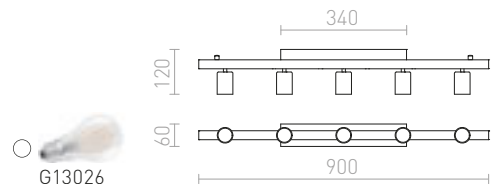

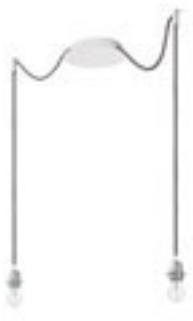

R11778
€ 178

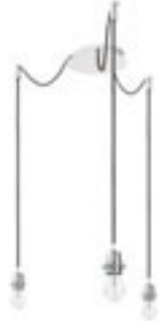

R11779
€ 215



R11780
€ 360



R11781
€ 158



R11782
€ 198



R11783
€ 329



R11787
€ 150



R11788
€ 198



R11789
€ 329

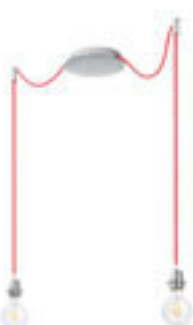

R11784
€ 150



R11785
€ 198

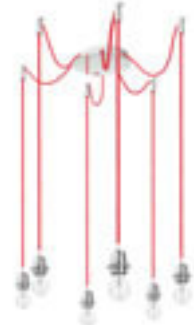

R11786
€ 398



R11778 + R11563



R11783 + R11810



KOMBIX

Luminária suspensa com base de teto central e cabos têxteis individuais com casquilho metálico E27, para uso com fontes de luz decorativas ou abajures têxteis adequados. Os cabos estão equipados com alças de cromo de teto, que podem ser colocadas a uma distância individual da base. Comprimento total do cabo 3m.

KOMBIX 2 CONJUNTO DE SUSPENSÃO

230 V E27 2x28 W

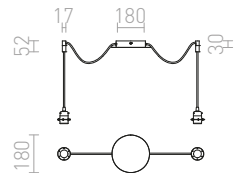

KOMBIX 3 CONJUNTO DE SUSPENSÃO

230 V E27 3x28 W

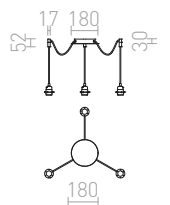

KOMBIX 6 CONJUNTO DE SUSPENSÃO

230 V E27 6x28 W

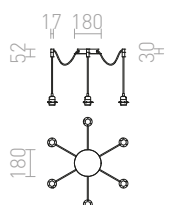



R11915
€ 68



R11914
€ 68



R11910
€ 68



R11911
€ 68



R11932
€ 78



R11943
€ 68



R11930
€ 68



R11938
€ 78



R11920
€ 68



R11918
€ 68



R11940
€ 78



R11909
€ 68



R11916
€ 68



R11912
€ 68



R11913
€ 68



R11945
€ 68



R11942
€ 68



R11941
€ 68



R11944
€ 68



R11931
€ 68



R11919
€ 68



R11927
€ 68



R11929
€ 68



R11917
€ 68



R11926
€ 68



R11923
€ 68

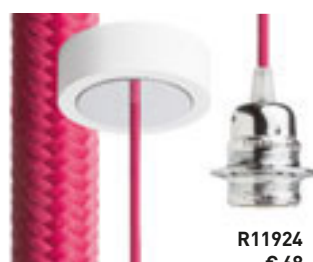

R11924
€ 68



R11922
€ 68



R11925
€ 68



R11937
€ 78



R11939
€ 78



R11935
€ 78



R11933
€ 68



R11934
€ 68



R11936
€ 78

HEX

Conjunto de suspensão com base decorativa, casquilho metálico E27 e cabo têxtil. Adequado apenas para suportes ou suspensão de abajures leves. Adequada para abajures: DOUBLE 40/30, DOUBLE 55/30, ASPRO 40/30, ASPRO 55/30, KARO 55/15, KARO 80/20, RON 40/25, RON 55/30, RON 60/19 TEMPO 30/19, TEMPO 50/19.

HEX CONJUNTO DE SUSPENSÃO

230 V E27 28 W

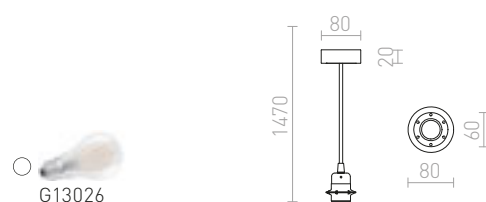



R11879
€ 58



R11886
€ 58



R11880
€ 48



R11892
€ 58



R11884
€ 58



R11888
€ 58



R11877
€ 58



R11891
€ 58



R11875
€ 58



R11896
€ 58



R11876
€ 58



R11894
€ 58



R11906
€ 58



R11885
€ 58



R11883
€ 58



R11882
€ 58



R11881
€ 58

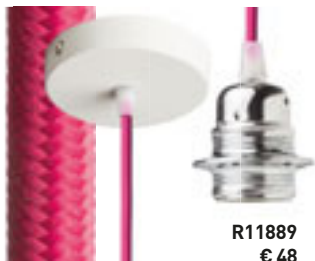

R11889
€ 48



R11872
€ 58



R11887
€ 58



R11890
€ 58



R11874
€ 58



R11873
€ 58



R11878
€ 58



R11908
€ 58



R11897
€ 58



R11895
€ 58



R11893
€ 58



R11898
€ 58



R11905
€ 58



R11904
€ 58



R11903
€ 58



R11907
€ 58



R11900
€ 58



R11902
€ 58



R11901
€ 58



R11899
€ 58

ELISA

Conjunto de suspensão com base circular lacada branca, cabo têxtil e casquilho de metal E27. Para uso autónomo ou para suspensão de abajures leves. Adequada para abajures: ARISTA, DELI, JAKARANDA, DOUBLE 40/30, DOUBLE 55/30, ASPRO 40/30, KARO 55/15, RON 40/25, RON 55/30, RON 60/19, TEMPO 30/19, TEMPO 50/19.

ELISA CONJUNTO DE SUSPENSÃO

230 V E27 28 W

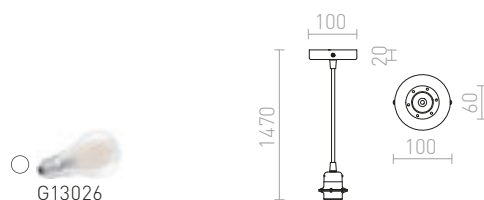



G12246

FABIO

Conjunto de suspensão elegante com copo em porcelana e casquilho E27 sobre um cabo têxtil. Adequado somente com fontes de luz decorativas. Dimensões do bocal de cerâmica ØV 4.5/6 cm.

FABIO CONJUNTO SUSPENSO

230 V E27 42 W

R10617 preto/branco/porcelana

R10618 preto/porcelana

€ 35 %

€ 35 %

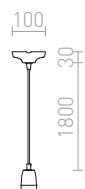



LISA

Conjunto de suspensão com cabo têxtil, bocal de silicone E27 e copo de plástico. Abajures adequados: ARISTA, DELI, DELISA, JAKARANDA, DOUBLE 40/30, DOUBLE 55/30, ASPRO 40/30, ASPRO 55/30, KARO 55/15, KARO 80/20, RON 15/20, RON 40/25, RON 55/30, RON 60/19, TEMPO 15/15, TEMPO 15/30, TEMPO 30/19, TEMPO 50/19.

LISA CONJUNTO SUSPENSO

230 V E27 42 W

R10622 vermelho	€ 28
R10623 verde	€ 15 %
R10624 branco	€ 28
R10625 preto	€ 28

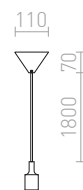

ENZO

Conjunto suspenso com elementos cromados, cabo transparente e casquilho E27. Abajures adequados: ARISTA, DELI, DELISA, JAKARANDA, DOUBLE 40/30, DOUBLE 55/30, ASPRO 40/30, ASPRO 55/30, ASPRO 55/30, KARO 55/15, KARO 80/20, RON 15/20, RON 40/25, RON 55/30, RON 60/19, TEMPO 15/15, TEMPO 15/30, TEMPO 30/19, TEMPO 50/19.

ENZO CONJUNTO SUSPENSO

230 V E27 42 W

R10616 cromo	€ 32
---------------------	-------------

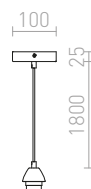



SOLO

Base de teto para abajures têxteis com casquilho E27.
Adequada para abajures: DELI 30/20, DOUBLE 40/30,
JAKARANDA, RON 40/25, TEMPO 30/19.

SOLO SQ BASE DE TETO

230 V E27 53 W

R12584 cromo

€ 28

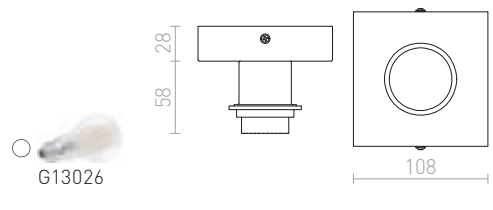

SOLO R BASE DE TETO

230 V E27 53 W

R12583 cromo

€ 28

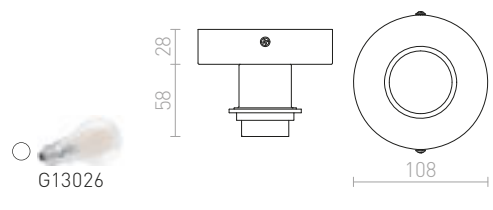

POSTE

Base de teto cromada com três casquilhos E27
ajustáveis. Adequada para abajures têxteis maiores que
30 cm. Para abajures: DELI 55/30, DOUBLE 55/30, RON
55/30, RON 60/19, TEMPO 50/19.

POSTE BASE PARA TETO

230 V E27 3x20 W

R11799 cromo

€ 68

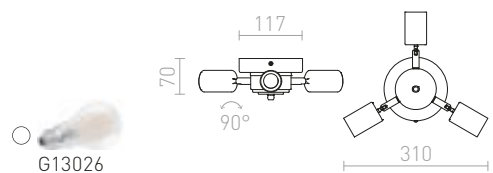



TRIX

Conjunto de suspensão com três casquilhos inclináveis a 90°. Abajures adequados: DOUBLE 55/30, ASPRO 55/30, KARO 55/15, KARO 80/20, RON 55/30, RON 60/19, TEMPO 50/19.

TRIX CONJUNTO SUSPENSO

230 V E27 3x42 W

R10615 cromo

€ 120

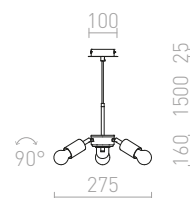



SPIDER

Conjunto variável adequado para uso autónomo com uma fonte de luz E27 decorativa ou com um abajur leve. O conjunto pode ser fixado no teto ou parede usando as alças colocadas no cabo têxtil preto. O conjunto contém 4 peças de alças de plástico pretas ou 4 alças de cromo. Estas também podem ser pedidas separadamente. Adequada para abajures: ARISTA, ASPRO, DOUBLE, JAKARANDA, RON.

SPIDER I CONJUNTO SUSPENSOS

230 V E27 15 W

R13492 preto

€ 58

R13493 preto/cromo

€ 78

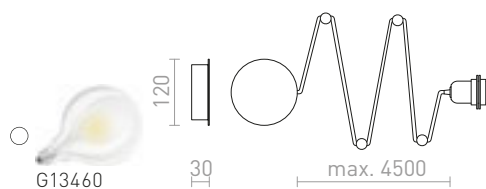



SPIDER

Acessórios de substituição para o conjunto SPIDER R13492 e R13493.

SPIDER JUNTA

R13494 preto/plástico

€ 2.35

R13495 cromo/metálico

€ 5.80

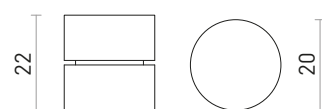





HUDSON

Luminária de parede com braço cromado, cabo vertical e abajur cilíndrico têtil.

HUDSON NA PAREDE

230 V E27 28 W

R13284 branco/cromo

€ 150

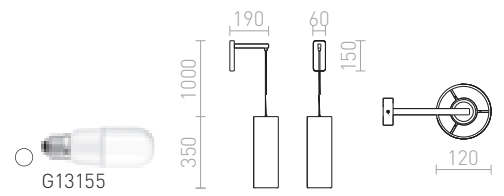

BEND

Luminária de parede em níquel com interruptor localizado no cabo de alimentação. Adequada para abajures têxteis com acessórios E27. Adequada para abajures: RON 40/25, ASPRO 40/30.

BEND BASE ARQUEADA NA PAREDE

230 V E27 42 W

R12654 níquel mate

€ 178

%

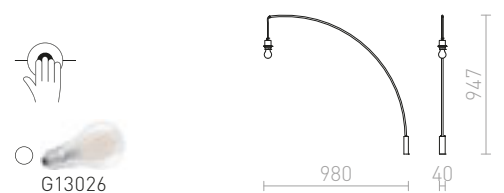



NIZZA

Base de candeeiro de mesa com braço ajustável em madeira e base de metal lacada a preto. Cabo de têxtil preto. Para abajur com montagens E14 ou E27.

NIZZA SUPORTE DE MESA

230 V E14 28 W

R12947 branco/madeira

€ 138

%



G12243

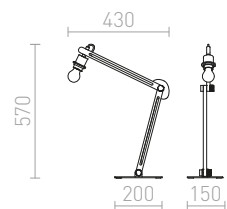



NIZZA

Abajur têxtil para casquilho E27, adequado para instalação em conjuntos suspensos e candeeiros de mesa R12947.

NIZZA 18/15 ABAJUR

max 28 W

R13113 Poli-algodão branco/PVC branco

€ 58

R13114 Poli-algodão preto/PVC branco

€ 58

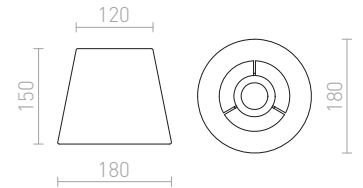

WOODY

Suporte de candeeiro de pé com casquilho E27. O interruptor está localizado na base da casquilho E27 para facilitar a operação. Adequada para abajures: DELISA 25/16, CONNRY 15/30, CONNRY 35/30, RON 40/25, TEMPO 30/19.

WOODY BASE CANDEEIRO DE MESA

230 V E27 25 W

R11791 carvalho

€ 98

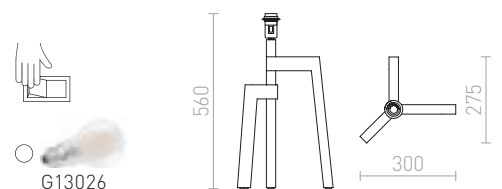

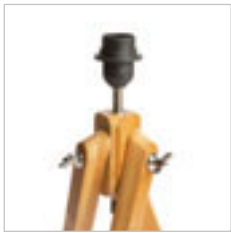

AMBITUS

Base de candeeiro de mesa de bambu com casquilho E27. Abajures adequados: ALVIS 24/15, DELISA 25/16, CONNY 15/30, CONNY 35/30, RON 40/25, TEMPO 30/19.

AMBITUS BASE CANDEEIRO DE MESA

230 V E27 28 W

R13303 bambu

€ 120



G13026

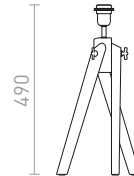

490



250

AMBITUS

Base de candeeiro de pé de bambu com casquilho E27. Abajures adequados: AMBITUS 46/24, DELISA 35/30, CONNY 25/30, CONNY 35/30, RON 40/25, TEMPO 30/19.

AMBITUS BASE CANDEEIRO DE PÉ

230 V E27 28 W

R13304 bambu

€ 268



G13461

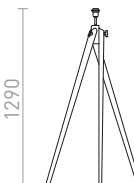

1290

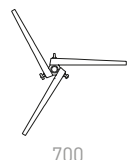

700



ALVIS

Tripé para candeeiro de pé de bambu regulável na altura para abajures com montagem E27. Adequada para abajures: AMBITUS 46/24, DELISA 35/30, CONNY 25/30, CONNY 35/30, RON 40/25, TEMPO 30/19.

ALVIS BASE CANDEIRO DE PÉ

230 V E27 28 W

R13340 bambu/cromo

€ 229



G13461

775 - 1210

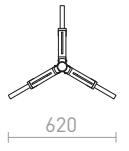

620

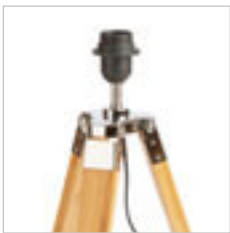

ALVIS

Suporte para candeeiro de mesa em bambu para abajures com montagem E27. Indicado para abajures: ALVIS 24/15, DELISA 25/16, CONNY 15/30, CONNY 35/30, RON 40/25, TEMPO 30/19.

ALVIS BASE CANDEIRO DE MESA

230 V E27 28 W

R13339 bambu/cromo

€ 120



G13014

510

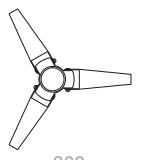
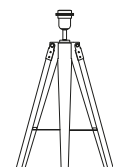

300



KEITH

Base de mesa em reprodução de faia com porta USB integrada. Combine com abajures com casquilho E27. Adequada para abajures: CONNY 15/30, DELI 30/20, DELISA 25/16, RON 15/20.

KEITH BASE DE SUPORTE COM USB

230 V E27 40 W

R13639 branco/faia

€ 88 →



G13026

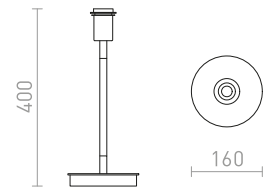

LUTON

Tripé elegante em preto com acessórios de latão. Combine com abajures com casquilho E27. Adequada para abajures: AMBITUS 46/24, DELISA 35/30, CONNY 25/30, CONNY 35/30, RON 40/25, TEMPO 30/19.

LUTON BASE DE PÉ

230 V E27 40 W

R13640 preto/latão

€ 150 →



G13026

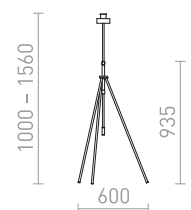



MAUI

Suporte de candeeiro de mesa de madeira com casquilho E27. Abajures adequados: CONNY 15/30, DELI 30/20, DELISA 25/16, RON 15/20.

MAUI BASE CANDEEIRO DE MESA

230 V E27 20 W

R13437 madeira

€ 48 %

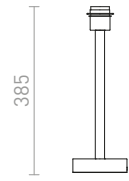

NYC

Suporte de pé cromado para abajures com montagem E27. Abajures adequados: CONNY 25/30, CONNY 35/30, JAKARANDA, RON 40/25, TEMPO 30/19.

NYC TRIPOD TRIPOD CANDEEIRO DE PÉ

230 V E27 42 W

R11992 cromo

€ 120

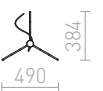



CORTINA

Base para candeeiro de mesa para abajures com montagem no casquilho E27. Adequada para abajures: CONNY 15/15, CONNY 15/30, RON 15/20, TEMPO 15/15, TEMPO 15/30.

CORTINA ABAJUR DE MESA

230 V E27 28 W

R12927 cinzento

€ 24 %

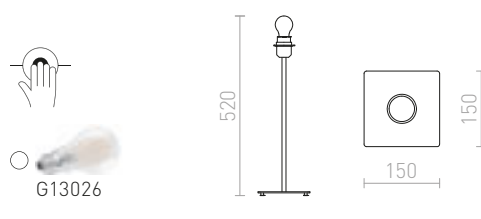

CORTINA

Base de metal para candeeiro de pé para abajures com montagem no casquilho E27. Adequada para abajures: CONNY 25/30, CONNY 35/30, RON 40/25, TEMPO 30/19.

CORTINA BASE CANDEEIRO DE PÉ

230 V E27 28 W

R12930 preto

€ 88 →

R13809 branco

€ 88 →





NYC

Suporte de mesa em metal brilhante e mate para abajures com montagem E27. Adequada para abajures: CONNY 15/15, CONNY 15/30, RON 15/20, TEMPO 15/15, TEMPO 15/30.

NYC BASE CANDEEIRO DE MESA

230 V E27 42 W

R11990 cromo

€ 58

R12041 níquel mate

€ 58



G13026

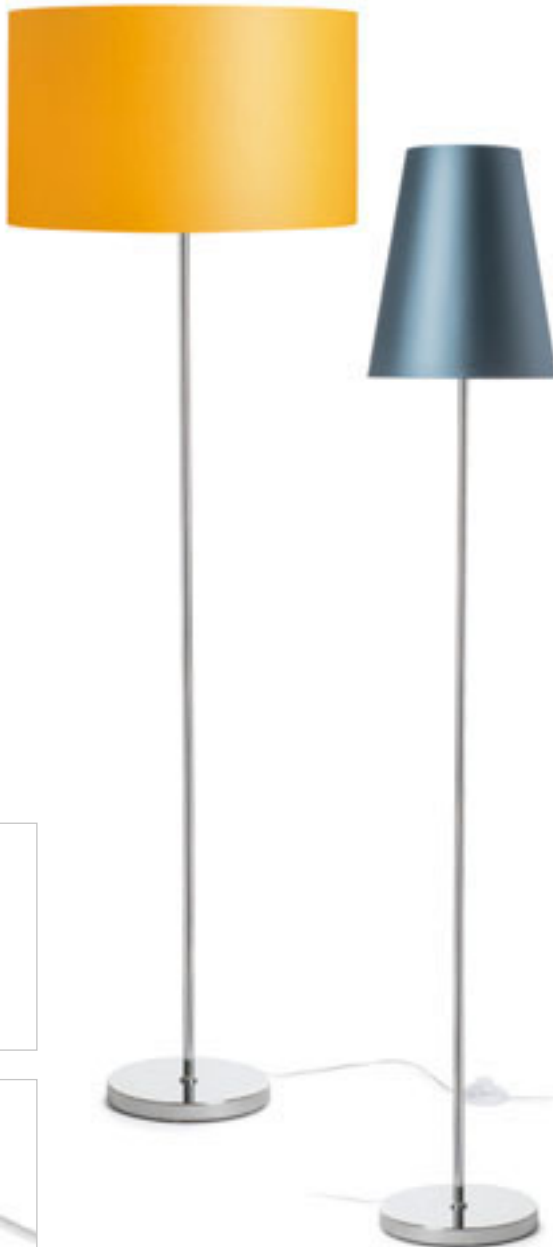
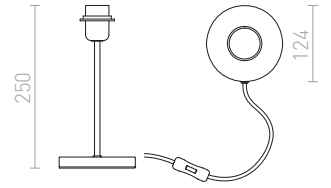

NYC

Suporte de pé com acabamento cromado para abajures com montagem E27. Adequada para abajures CONNY 25/30, CONNY 35/30, JAKARANDA, RON 40/25, TEMPO 30/19.

NYC CANDEEIRO DE PÉ

230 V E27 42 W

R11991 cromo

€ 120



G13026

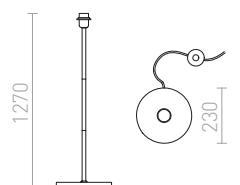



FIT

Cabo triplo com trança têxtil em diferentes cores, comprimento 4 m.

FIT 3x0,75 4M CABO TÊXTEL

230 V

R10251 preto

€ 24

R10252 branco

€ 14 %

R10253 vermelho

€ 14 %

R10254 cinzento

€ 14 %

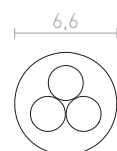

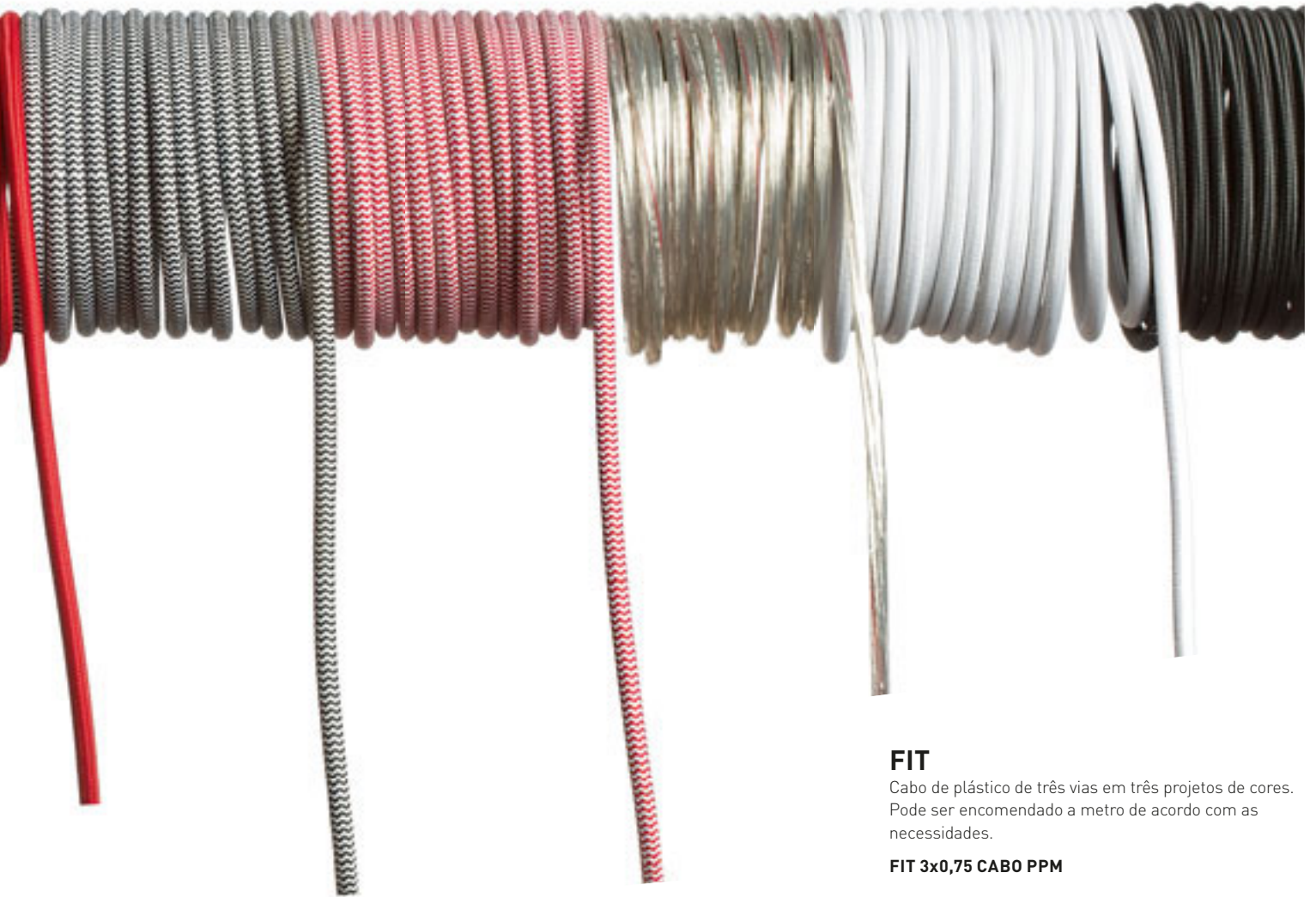

FIT

Cabo de plástico de três vias em três projetos de cores. Pode ser encomendado a metro de acordo com as necessidades.

FIT 3x0,75 CABO PPM

R12228	transparente	€ 3.50
R12229	cinzento	€ 3.20
R12230	preto	€ 3.20

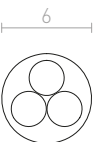

FIT

Cabo triplo com trança têxtil em cores diferentes. Pode ser encomendado a metro de acordo com as necessidades.

FIT 3x0,75 CABO TÊXTIL PPM

R12214	branco	€ 5
R12216	preto/branco	€ 5
R12222	preto	€ 5
R12223	cinzento	€ 5
R12224	vermelho	€ 5
R12225	lima	€ 5
R12226	fuchsia	€ 5
R12227	vermelho/branco	€ 5

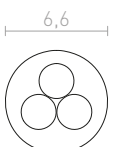
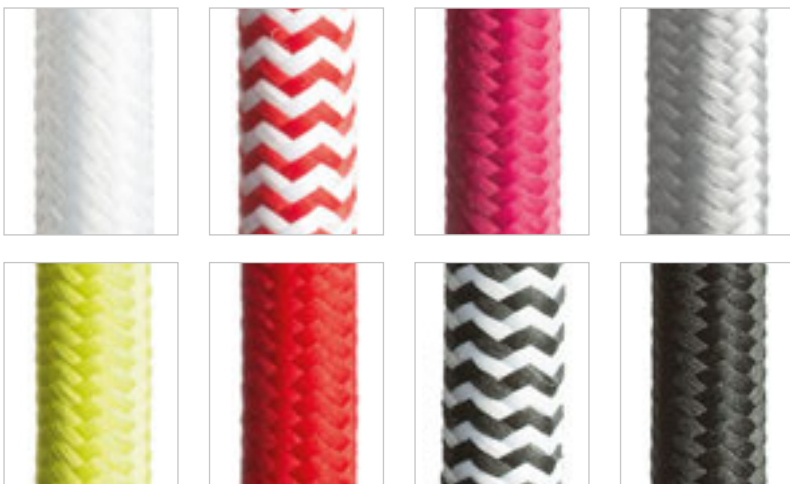



ILUMINAÇÃO EXTERIOR

DECORATIVO	628-629
CONJUNTOS	630-645
TETO	646-653
INDIRETO	654-655
PAREDE ANGULAR	656-671
ACIMA - ABAIXO	672-691
PAREDE DIRECIONAL	692-695
DE ESTACA	696-701
CANDEEIROS DE ORIENTAÇÃO	702-709
EMBUTIDO EM PAREDE	710-721
EMBUTIDO NO SOLO	722-725

ILUMINAÇÃO EXTERIOR DECORATIVO



BABYMOON 56
628-629



BEACON
628-629

ILUMINAÇÃO EXTERIOR CONJUNTOS

628-629



ELIA
630-631



ELIA PIR
630-631



ELIA
630-631

630-645



BOSANNA 150
630-631



BOSANOVA 120
630-631



BONNIE
632-633



BONNIE 80
632-633



CLYDE
632-633



CLYDE 60
632-633



VADIS 90
634-635

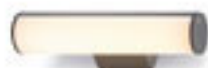

VADIS
634-635



GARRET
634-635



SONET
636-637



SONET 450
636-637



ABAX 65
636-637



AQUE
636-637



AQUE
636-637



PONDER 20
638-639



PONDER 65
638-639



TREEZA LED 25
638-639



TREEZA 65
638-639



RINA
640-641



RINA
640-641



RINA PIR
640-641



GARDIEN 65
640-641



BOBO RC
640-641



SORANO
642-643



SORANO II
642-643



LIZZI
642-643



LIZZI I
642-643



LIZZI II
642-643



MIZZI NEW I, II
644-645



MIZZI II
644-645

ILUMINAÇÃO EXTERIOR TETO



SENZA R
646-647



ORIN R
646-647



SAMMY
646-647

646-653



MERIDO
646-647



QUADRA M
648-649



RODGE
648-649



KEIG
648-649



SENZA SQ
648-649



ORIN SQ
648-649



SONNY
650-651



SONYA 30
650-651



SONYA RC
650-651



SCOTT
652-653



SPECTACLE
652-653



TARIS SQ 17
652-653



BONO
652-653

ILUMINAÇÃO EXTERIOR INDIRETO



ATLANTA 13
654-655



ATHI
654-655



AQUE
654-655

654-655

ILUMINAÇÃO EXTERIOR PAREDE ANGULAR



TWIST
654-655

656-671



CLAIRE RC
656-657

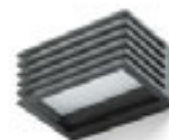

CLAIRE 14
656-657



CLAIRE 21
656-657



TIRAS II
656-657



WOOP
658-659



TORINO
658-659



CAMARGUE
658-659



SAMPO
658-659



DURANT
660-661



DURANT UP - DOWN
660-661



GINO
660-661



DELTA 145
662-663



DELTA 215
662-663



DELTA 215
662-663



DELTA 145
662-663



DELTA RC
664-665



CHICAGO
664-665



ASPEN
664-665



VERIA
664-665



ATHI
664-665



HIDE SQ
666-667



HIDE RC
666-667



ANDANTE
666-667



VECINO
668-669



CHLOE
668-669



TAPA
668-669



GAVIN
668-669



VIRGO
670-671



XYLO
670-671



COMODO
670-671



TWIST
670-671

ILUMINAÇÃO EXTERIOR ACIMA - ABAIXO



CABOX II
672-673



TELO
672-673



DESMOND II
672-673

672-691



MIZZI SQ I
672-673



CARRE
674-675



TITO R
674-675



TITO SQ
674-675



GRANITA II
676-677



KANE I
676-677



KANE II
676-677



ZAZA
678-679



PIA
678-679



GIGI
678-679

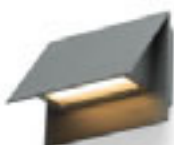

GERI
678-679



BOURDON
680-681



PIPER
680-681



SIV
680-681



SELMA
680-681



ZACK I
682-683



ZACK II
682-683



BEJA II
682-683



MIDZACK
682-683



KORSO I
684-685



KORSO II
684-685



KUBI I
684-685



KUBI II
684-685



DIXIE 4x12
686-687



DIXIE 10x16
686-687



PEKKO
686-687



NICK II
686-687



UKKO
686-687



MOIRE I
688-689



MOIRE II
688-689



MICO I
688-689



ZANE
688-689



CHOIX 114
690-691



CHOIX 175
690-691



MORA
690-691



LESA
690-691

ILUMINAÇÃO EXTERIOR PAREDE DIRECIONAL



DIREZZA
692-693



ORIT
692-693



FOX
692-693



BORA
694-695



PONTA
694-695

ILUMINAÇÃO EXTERIOR DE ESTACA

696-701



CORDOBA
696-697



DIREZZA
696-697



GUN
696-697



BLUESTAR
696-697



COSMO
698-699



GARY LED
698-699



BORA
698-699



LORCA
698-699



HEAVY DUTY
700-701



ROSS
700-701



FOX
700-701

ILUMINAÇÃO EXTERIOR CANDEIROS DE ORIENTAÇÃO

702-709



TOPTOP S I
702-703



TOPTOP S III
702-703



TOPTOP IV
702-703



FAROS
702-703



BOBO R
704-705



BOBO RC
704-705



BOBO SQ
704-705



RENO R
706-707



RENO SQ INDR
706-707



RENO SQ DR
706-707



AQILA R
708-709



AQILA SQ
708-709



AQILA RC
708-709



ILUMINAÇÃO EXTERIOR EMBUTIDO EM PAREDE



ITAKA
708-709

710-721

KICK I
710-711

KICK II
710-711



KICK III
710-711

ASTERIA
712-713

MARCO
712-713

CLUB
712-713

CLUB IND
712-713



ELICA R
712-713

ELICA SQ
714-715

TESS SQ
714-715

PER
714-715

RASQ
714-715



GORDIQ S
716-717

GORDIQ L
716-717

GORDIQ M
716-717

RAGG
716-717

DEJAVU SQ 9
718-719



DEJAVU SQ 14
718-719

DEJAVU RC
718-719

FACA
720-721

GAP
720-721

AKORD
720-721



SEGNO
720-721

ILUMINAÇÃO EXTERIOR EMBUTIDO NO SOLO



NAVY
722-723



TERRA
722-723



ORBUR
722-723

722-725



RIZZ SQ 105
724-725



RIZZ SQ 125
724-725



ORBUR SQ 10
724-725





IP44

IP44

BABYMOON

Esfera de opala em termoplástico para fontes de luz de baixo consumo energético, adequadas para uso no jardim. A luz pode ser usada como suspensa ou no chão. Inclui um cabo de alimentação de 170 cm.

BABYMOON 56 SUSPENSO OU DE PÉ

230 V E27 23 W IP44

R10372 PE acetinado

€ 398

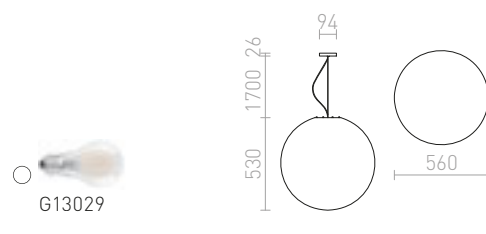

IP44

BEACON

Candeeiro de parede retro para exterior com máscara de vidro transparente para fonte de luz com casquilho E27.

BEACON NA PAREDE

230 V E27 60 W IP44

R13614 preto/vidro texturado

€ 129

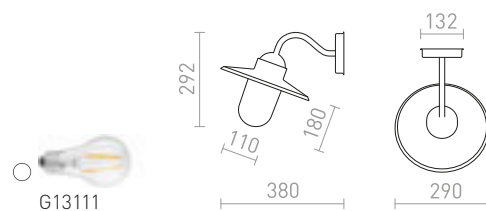



IP65

IP65

BOSANOVA

Luminária de pé exterior com abajur de plástico. O cabo de alimentação é fornecido com uma ficha de segurança.

BOSANOVA 120 DE PÉ

230 V E27 25 W IP65

R12420 cinzento antracite/PE acetinado

€ 398



G13026

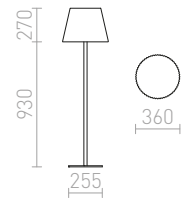

BOSANNA

Luminária de pé exterior com abajur de plástico. O cabo de alimentação é fornecido com uma ficha de segurança.

BOSANNA 150 DE PÉ

230 V E27 25 W IP65

R12421 cinzento antracite/PE acetinado

€ 380



G13026

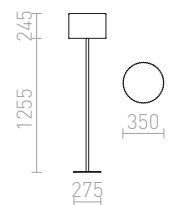



IP44

ELIA

Candeeiro de parede exterior em alumínio maciço com LED incorporado e difusor de cor opala, da série ELIA

ELIA NA PAREDE

230 V LED 9 W 3000 K 720 lm Ra 80 IP44

R13930 cinzento antracite

€ 98

NEW

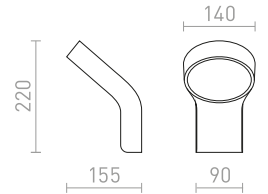

IP44



ELIA

Candeeiro de parede exterior em alumínio maciço com LED incorporado e difusor de cor opala, da série ELIA. Inclui um sensor de movimento configurável.

ELIA PIR NA PAREDE

230 V LED 9 W 3000 K 720 lm Ra 80 IP44

R13931 cinzento antracite

€ 129

NEW

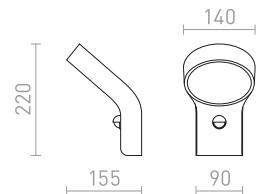

IP44



ELIA

Poste exterior de alumínio maciço com LED incorporado e difusor de cor opala, da série ELIA.

ELIA DE PÉ

230 V LED 9 W 3000 K 720 lm Ra 80 IP44

R13932 cinzento antracite

€ 178

NEW

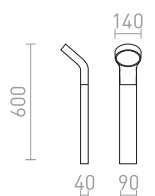



IP44

BONNIE

Candeeiro de parede exterior com tampa opala para fonte de luz LED com casquilho E27.

BONNIE NA PAREDE

230 V E27 28 W IP44

R13635 cinzento antracite

€ 48



G13307

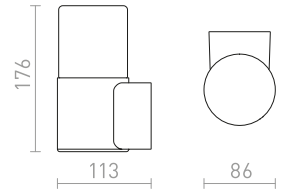

IP44

BONNIE

Candeeiro de pé exterior com tampa opala para fonte de luz LED com casquilho E27.

BONNIE 80 VERTICAL

230 V E27 28 W IP44

R13636 cinzento antracite

€ 129



G13307

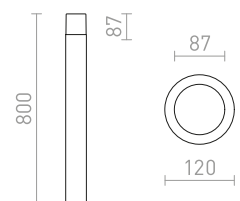



IP44



IP44



CLYDE

Candeeiro de parede exterior com tampa opala para fonte de luz LED com casquilho E27.

CLYDE NA PAREDE

230 V E27 28 W IP44

R13637 cinzento antracite

€ 58

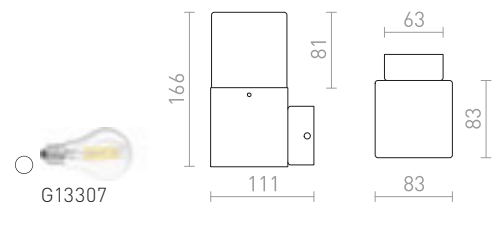

CLYDE

Candeeiro de pé exterior com tampa opala para fonte de luz LED com casquilho E27.

CLYDE 60 VERTICAL

230 V E27 28 W IP44

R13638 cinzento antracite

€ 120

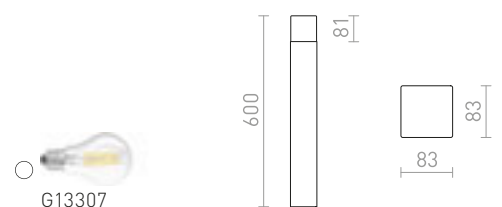



IP65

GARRET

Luminária de parede LED cilíndrica de exterior com iluminação ambiente.

GARRET NA PAREDE

230 V LED 15 W 3000 K 750 lm Ra 80 IP65

R12548 cinzento antracite

€ 120 %

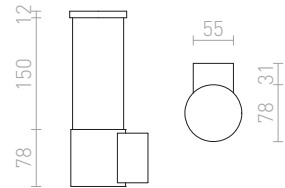
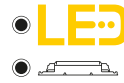

IP54

VADIS

Luminária de exterior com tecnologia LED. O abajur é feito de policarbonato fosco.

VADIS NA PAREDE

230 V LED 8 W 3000 K 520 lm Ra 80 IP54

R10547 cinzento antracite

€ 150

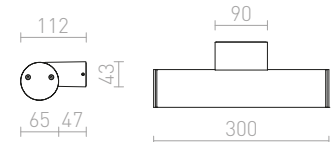

IP54

VADIS

Baliza de exterior em alumínio lacado com LED integrado e laca de acrílico fosco.

VADIS 90 VERTICAL

230 V LED 8 W 3000 K 520 lm Ra 80 IP54

R10548 cinzento antracite

€ 248

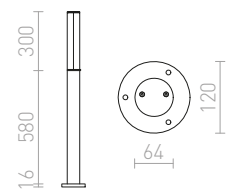





IP54

SONET

Luminária exterior projetada apenas para montagem em parede. Classe de proteção IP54. Iluminação descendente.

SONET NA PAREDE

230 V LED 7 W 3000 K 490 lm Ra 80 IP54

R11170 cinzento antracite

€ 138

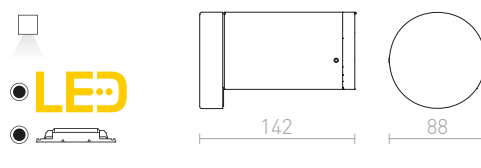

IP54

AQUE

Luminária LED de parede exterior, com a possibilidade de ajustar o foco no eixo.

AQUE NA PAREDE

230 V LED 8 W 3000 K 800 lm Ra 80 IP54

R12623 mate preto

€ 150

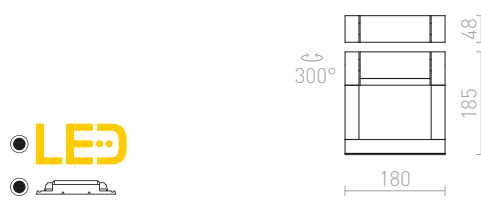

IP54

AQUE

Elegante baliza ao ar livre com a possibilidade de ajustar o foco no eixo.

AQUE VERTICAL

230 V LED 8 W 3000 K 800 lm Ra 80 IP54

R12624 mate preto

€ 198

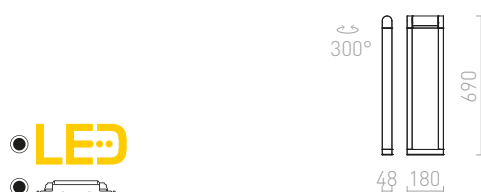



IP54

SONET

Baliza ao ar livre com LED integrado para iluminar estradas e pavimentos.

SONET 450 VERTICAL

230 V LED 7 W $\angle 55^\circ$ 3000 K 477 lm Ra 80 IP54

R11171 cinzento antracite

€ 198

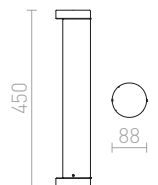
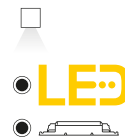

IP54

ABAX

Baliza cilíndrica de exterior com LED integrado para iluminação geral.

ABAX 65 DE PÉ

230 V LED 15 W 3000 K 423 lm Ra 80 IP54

R12626 cinzento antracite

€ 320

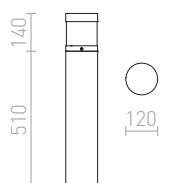



IP54

IP54

TREEZA

Baliza ao ar livre com a área da fonte de luz lacada com cor dourada, o que cria uma luz macia e morna.

TREEZA LED 25 VERTICAL

230 V LED 7 W $\angle 60^\circ$ 3000 K 123 lm Ra 80 IP54

R10380 cinzento antracite

€ 188

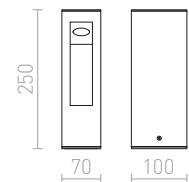

TREEZA

Baliza ao ar livre para fontes de luz com baixo consumo energético E27. O vidro é acetinado.

TREEZA 65 VERTICAL

230 V E27 26 W IP54

R10441 cinzento antracite

€ 158

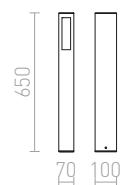



IP44

IP44

PONDER

Luminária de pé para exteriores de alumínio fundido com abajur de vidro acetinado. Pode ser utilizada tanto na parede, como no chão.

PONDER 20 PAREDE OU LEVANTADO

230 V E27 18 W IP44

R10367 preto

€ 98

R10368 cinzento prata

€ 78 →

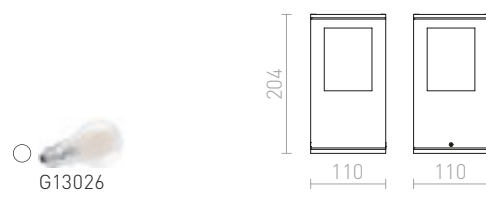

PONDER

Baliza ao ar livre para fontes de luz com baixo consumo energético E27 e cobertura de vidro acetinado.

PONDER 65 SUPORTE

230 V E27 18 W IP44

R10433 preto

€ 158





IP65



BOBO

Poste de exterior em alumínio com LED incorporado, para iluminação diagonal descendente de caminhos e entradas.

BOBO RC DE PÉ

230 V LED 8W 3000 K 640 lm Ra 80 IP65

R13936 cinzento antracite

€ 158

NEW

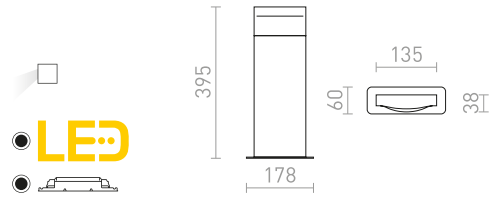

IP44

RINA

Baliza ao ar livre de alumínio fundido com LED integrado e cobertura inferior de opala. Apenas para iluminação descendente.

RINA DE PÉ

230 V LED 12W 3000 K 1000 lm Ra 80 IP44

R12515 cinzento antracite

€ 229

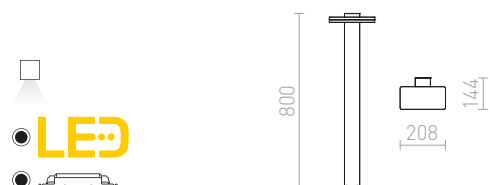



IP65

RINA

Luminária de parede LED exterior de alumínio fundido com LED integrado e uma cobertura inferior em cor opala. Apenas para iluminação descendente.

RINA NA PAREDE

230 V LED 12 W 3000 K 1000 lm Ra 80 IP65

cinzento antracite

€ 150

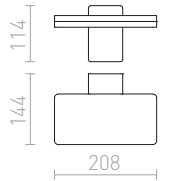
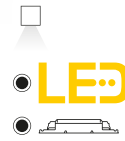

IP65

RINA

Aplique LED para exterior com sensor integrado - possibilidade de definir funções. Apenas para iluminação descendente. Fabricado em alumínio fundido, tampa inferior opala.

RINA PIR NA PAREDE

230 V LED 12 W 3000 K 900 lm Ra 80 IP65

R13654 cinzento antracite

€ 178

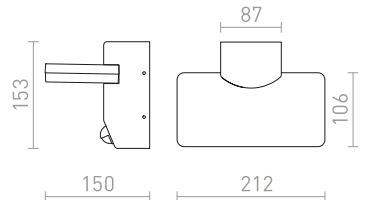
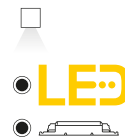

IP54

GARDIEN

Candeeiro de pé LED para exterior em alumínio fundido com iluminação descendente. Os LEDs são cobertos por uma tampa de vidro fosco.

GARDIEN 65 VERTICAL

230 V LED 10 W 3000 K 600 lm Ra 80 IP54

R13758 preto

€ 178

NEW

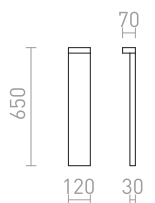
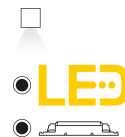



IP54



LIZZI

Foco externo com casquilho GU10.

LIZZI TETO

230 V GU10 35 W IP54

R13505 branco

€ 58

R13506 cinzento prata

€ 58

R13507 cinzento antracite

€ 58

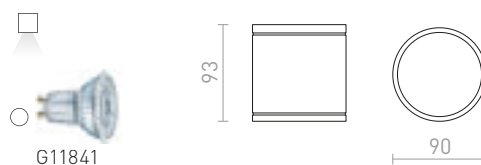

IP54



IP54

LIZZI

Foco de alumínio para exteriores para fontes de luz GU10. O tamanho da base é A/L/D 10/6/3.1 cm.

LIZZI I NA PAREDE

230 V GU10 35 W IP54

R13508 cinzento antracite

€ 68

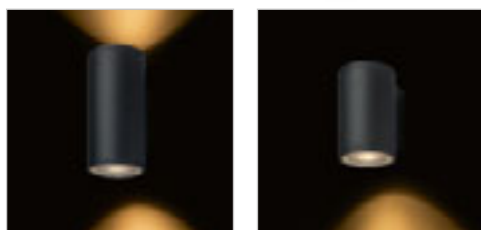
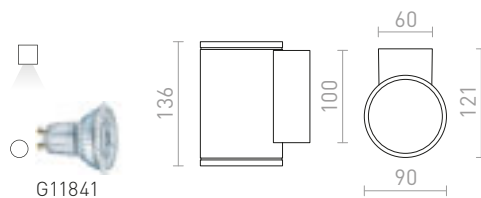

LIZZI II NA PAREDE

230 V GU10 2x35 W IP54

R13509 cinzento antracite

€ 78

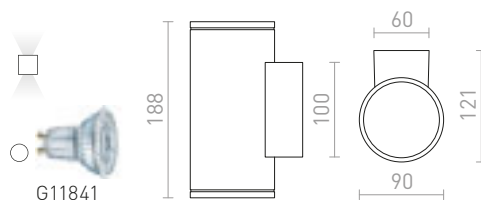



IP44



IP44



SORANO

Cilindro de teto em fibra de carbono para fonte de luz LED com casquilho GU10. O corpo de carbono da luminária tem uma elevada resistência à água salgada.

SORANO TETO

230 V LED GU10 8 W IP44

R13633 preto/plástico

€ 24

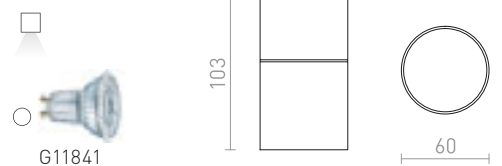

SORANO II NA PAREDE

230 V LED GU10 2x8 W IP44

R13634 preto/plástico

€ 35

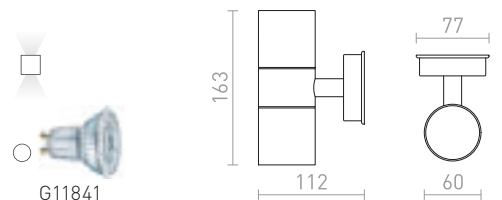



IP65



IP54

MIZZI NEW

Candeeiro de parede de exterior em alumínio fundido para fontes de luz com casquilho GU10.

MIZZI NEW I NA PAREDE

230 V GU10 35 W IP65

R13755 cinzento antracite

€ 58

R13796 cinzento prata

€ 58

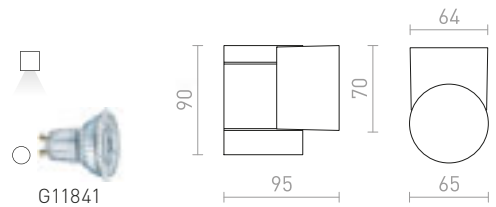

MIZZI NEW II NA PAREDE

230 V GU10 2x35 W IP65

R13643 cinzento antracite

€ 58

R13797 cinzento prata

€ 58

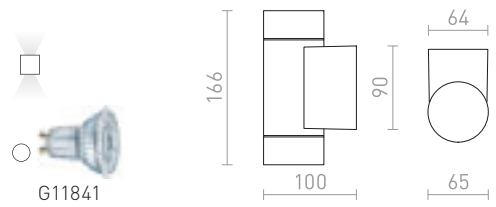

MIZZI

Aplique de exterior em alumínio fundido para fontes de luz com luz com GU10.

MIZZI II

230 V GU10 2x35 W IP54

R10553 cinzento prata

€ 48

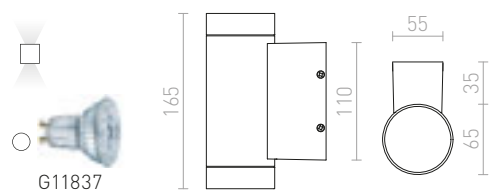





IP54



MERIDO

Luminária de teto exterior para fontes de luz GX53 de baixo consumo energético.

MERIDO TETO

230 V GX53 11 W IP54

R10428 branco

€ 68

R10429 cinzento prata

€ 68

R10430 cinzento antracite

€ 68

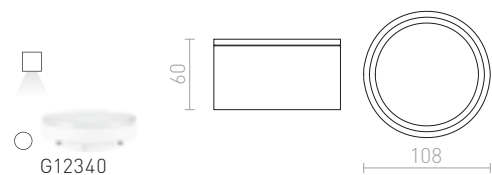



IP54

ORIN

Iluminação de teto cilíndrica LED para exterior com abajur acetinado.

ORIN R TETO

230 V LED 10 W 3000 K 650 lm Ra 80 IP54

R13626 branco/acrílico acetinado

€ 88

R13627 cinzento antracite/acrílico acetinado

€ 88

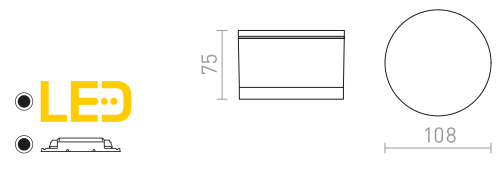

IP65

SENZA

Plafon LED para exterior. Luminária cilíndrica com tampa de vidro transparente preto em todo o perímetro.

SENZA R TETO

230 V LED 6 W 3000 K 480 lm Ra 80 IP65

R13622 branco/vidro transparente

€ 98

R13623 cinzento antracite/vidro transparente

€ 98

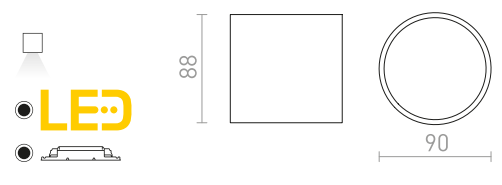

IP54

SAMMY

Foco de exterior com casquilho GU10. Com cobertura de vidro transparente na parte inferior.

SAMMY TETO

230 V LED GU10 15 W IP54

R13450 branco

€ 58

R13451 cinzento

€ 48

R13452 cinzento antracite

€ 58

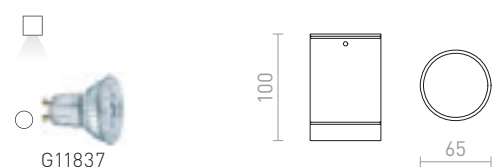



IP65

KEIG

Iluminação de teto quadrada para exterior para fonte de luz LED com casquilho GU10.

KEIG TETO

230 V GU10 35 W IP65

R13631 branco

€ 48

R13632 preto

€ 58

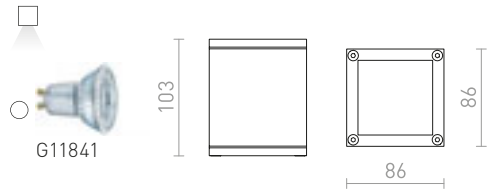

IP54

RODGE

Foco de exterior com casquilho GU10.

RODGE TETO

230 V GU10 35 W IP54

R13503 branco

€ 58

R13510 cinzento

€ 58

R13511 cinzento antracite

€ 58

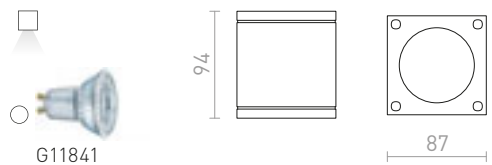

IP54

QUADRA M

Luminária de teto exterior para fontes de luz de halógeno PAR20.

QUADRA M TETO

230 V E27 75 W IP54

R10385 cinzento antracite

€ 68

R10386 cinzento prata

€ 48

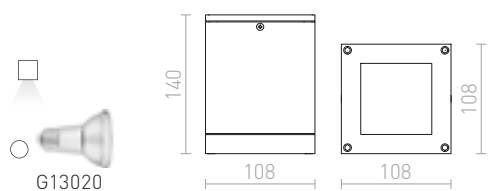



IP54

ORIN

Iluminação LED quadrada para teto com abajur acetinado.

ORIN SQ TETO

230 V LED 10 W 3000 K 800 lm Ra 80 IP54

R13628 branco/acrílico acetinado

€ 88

R13629 cinzento antracite/acrílico acetinado

€ 88

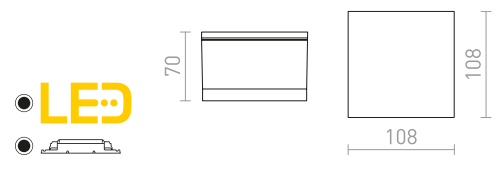

IP65

SENZA

Plafon de LED para exterior com cobertura de vidro transparente e circunda todo o perímetro.

SENZA SQ TETO

230 V LED 6 W 3000 K 580 lm Ra 80 IP65

R13624 branco/vidro transparente

€ 98

R13625 cinzento antracite/vidro transparente

€ 98

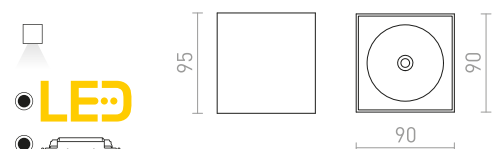





IP54

SONNY

Plafon de teto exterior para duas fontes de luz com poupança de energia.

SONNY TETO

230 V E27 2x18 W IP54

R10382 cinzento antracite

€ 98

R10383 cinzento prata

€ 98



G13026

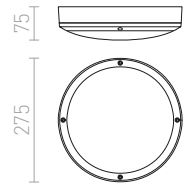

IP54

SONYA

Plafon de alumínio circular de exterior com difusor em acrílico opala para montagem no teto ou na parede.

SONYA RC

230 V E27 2x18 W IP54

R10363 cinzento prata

€ 68



G13026

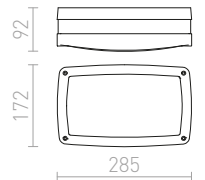

IP54

SONYA 30

230 V E27 2x18 W IP54

R10361 preto

€ 120

R10362 cinzento prata

€ 120



G13155

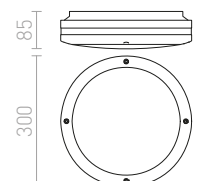

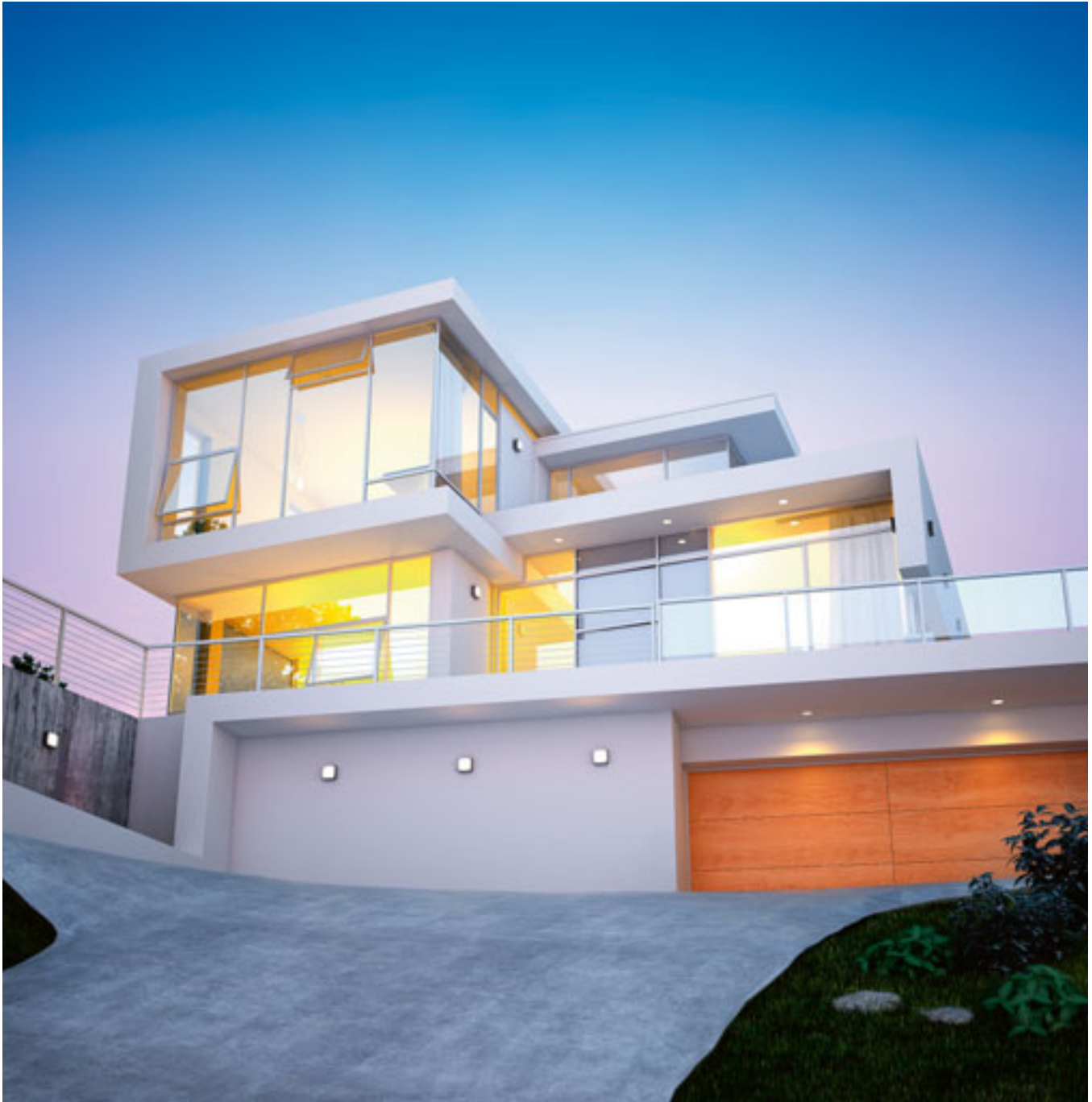

IP65

BONO

Luz externa de alumínio fundido com LED integrado e um difusor de cor opala. Para montagem no teto ou na parede.

BONO SUPERFÍCIE

230 V LED 4 W 3000 K 297 lm Ra 80 IP65

R11967 cinzento antracite

€ 178

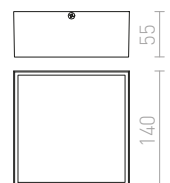
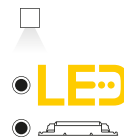



IP54



SCOTT

Luminária LED montada em superfície para uso exterior com cobertura frontal de acrílico fosco.

SCOTT TETO

230 V LED 9,8 W 3000 K 637 lm Ra 80 IP54

R10552 cinzento prata

€ 78

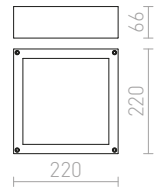
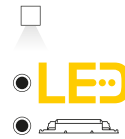

IP54

TARIS

Luminária LED de parede/teto quadrada com cantos arredondados.

TARIS SQ 17 DE SUPERFÍCIE

230 V LED 8 W 3000 K 550 lm Ra 80 IP54

R12525 preto/plástico

€ 28

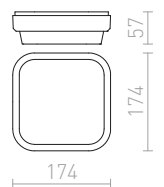

IP54

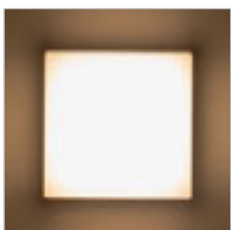

SPECTACLE

Luz externa de alumínio fundido com LED integrado e um difusor de cor opala. Para montagem em teto ou parede.

SPECTACLE SUPERFÍCIE

230 V LED 5 W 3000 K 350 lm Ra 80 IP54

R11968 cinzento prata

€ 120

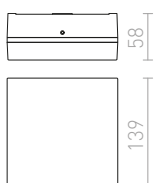



IP54

ATHI

Luminária de parede quadrada com LED integrado para iluminação indireta refletindo a luz da parede. Adequada para uso interior e exterior.

ATHI NA PAREDE

230 V LED 9,6 W 3000 K 550 lm Ra 80 IP54

R12551 branco

€ 120

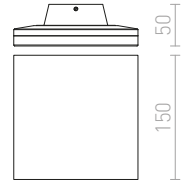

IP54

ATLANTA

Luminária de parede circular com LED integrado para iluminação indireta que reflete a luz da parede. Adequada para uso interior e exterior.

ATLANTA 13 DE SUPERFÍCIE

230 V LED 6 W 3000 K 780 lm Ra 80 IP54

R12825 branco

€ 78

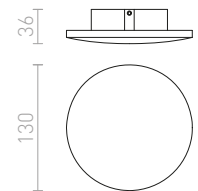

IP54

AQUE

Luminária LED de parede exterior, com a possibilidade de ajustar o foco no eixo.

AQUE NA PAREDE

230 V LED 8 W 3000 K 800 lm Ra 80 IP54

R12623 mate preto

€ 150

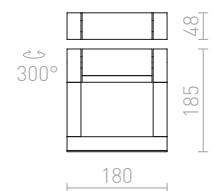



IP65

TWIST

Iluminação LED de parede em alumínio para exterior com a opção de definir a iluminação descendente ou como iluminação indireta ascendente.

TWIST NA PAREDE

230 V LED 12 W 3000 K 980 lm Ra 80 IP65

R13615 branco

€ 120

R13616 cinzento antracite

€ 120

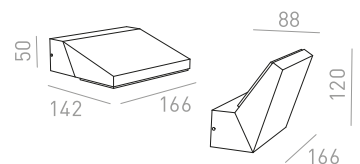



IP54

TIRAS

Candeeiro de parede LED para exterior em alumínio injetado lacado e difusor branco leite para iluminação difusa bidirecional.

TIRAS II NA PAREDE

230 V LED 2x6 W 3000 K 371 lm Ra 80 IP54

R13569 cinzento antracite/acrílico fosco

€ 78

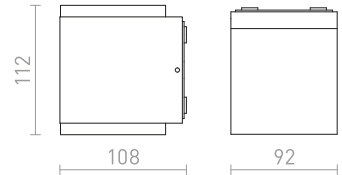

IP54

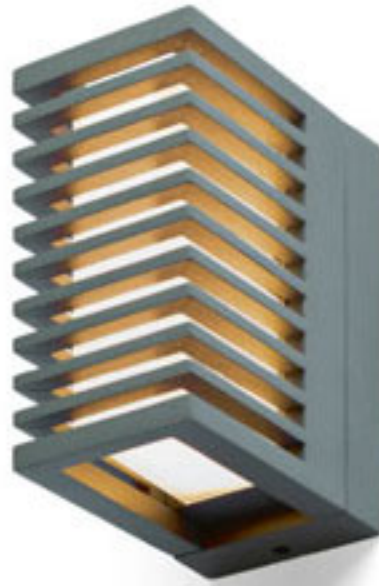

IP54

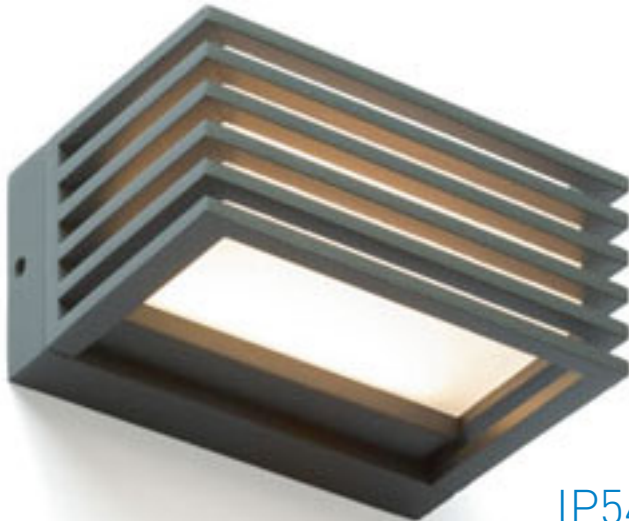

IP54

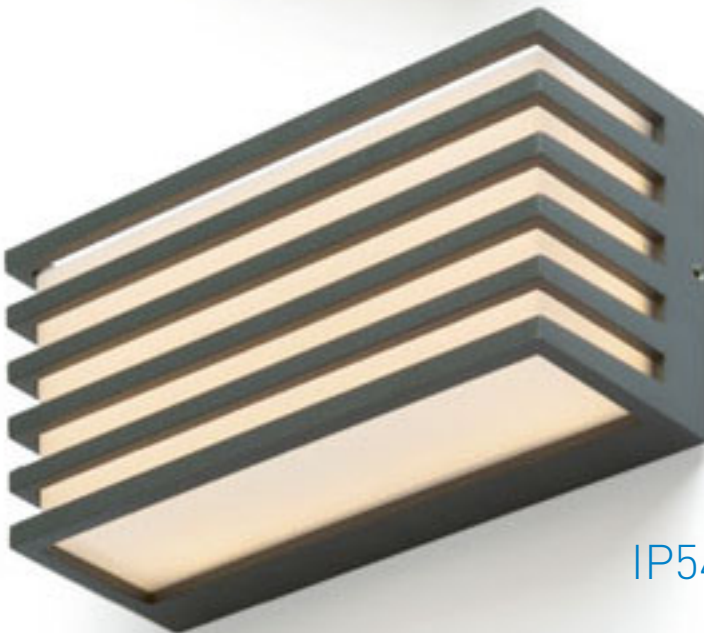

CLAIRE

Aplique LED lacado para exterior. O corpo é em alumínio injetado.

CLAIRE RC NA PAREDE

230 V LED 6 W 3000 K 143 lm Ra 80 IP54

R13563 cinzento antracite/acrílico fosco

€ 120

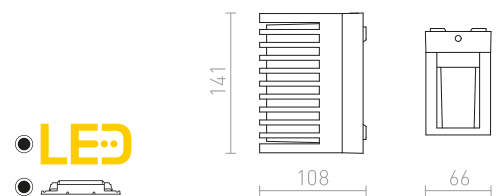

CLAIRE 14 NA PAREDE

230 V LED 6 W 3000 K 240 lm Ra 80 IP54

R13564 cinzento antracite/acrílico fosco

€ 120

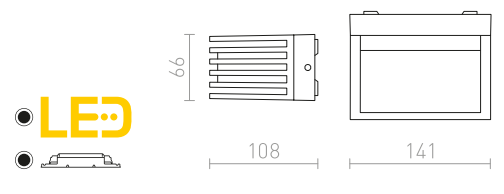

CLAIRE 21 NA PAREDE

230 V LED 9 W 3000 K 384 lm Ra 80 IP54

R13565 cinzento antracite/acrílico fosco

€ 150

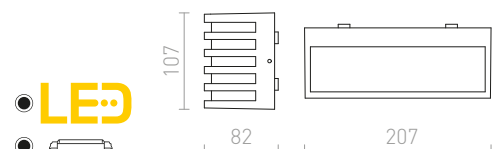

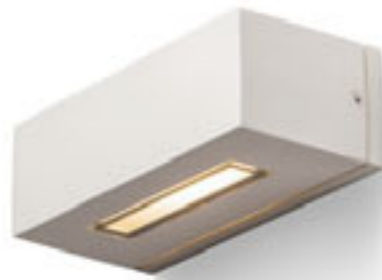

IP54



WOOP

Luminária de exterior bidirecional. Um dos lados da luminária tem vidro claro com moldura preta. O outro lado tem uma cobertura de vidro fosco com moldura preta.

WOOP NA PAREDE

230 V R7s 78mm 48 W IP54

R10437 branco

€ 68

R10438 cinzento prata

€ 48

R10439 cinzento antracite

€ 68

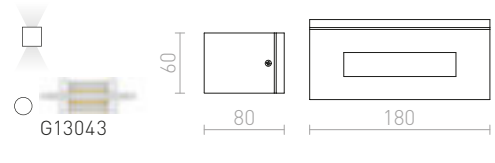

IP54

TORINO

Luminária LED retangular de parede com iluminação bidirecional.

TORINO NA PAREDE

230 V LED 2x5 W 3000 K 550 lm Ra 80 IP54

R12573 branco

€ 150

R12574 preto

€ 150

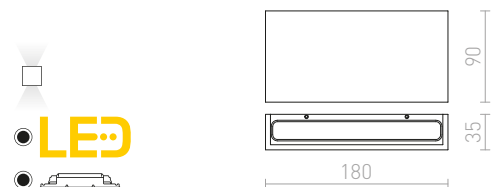



IP65

SAMPO

Iluminação externa LED em alumínio de parede de forma retangular com iluminação assimétrica descendente.

SAMPO NA PAREDE

230 V LED 9 W 3000 K 650 lm Ra 80 IP65

R13619 cinzento antracite

€ 98

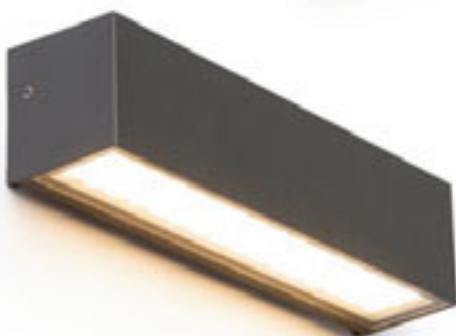
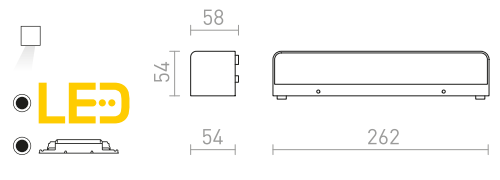

IP65

CAMARGUE

Aplique LED retangular com iluminação para descendente.

CAMARGUE NA PAREDE

230 V LED 6 W 3000 K 550 lm Ra 80 IP65

R13527 cinzento prata/vidro acetinado

€ 138

R13641 cinzento antracite/vidro acetinado

€ 138

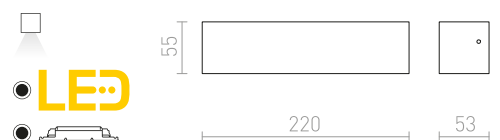

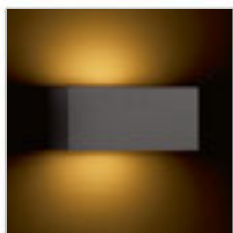

IP54



IP54

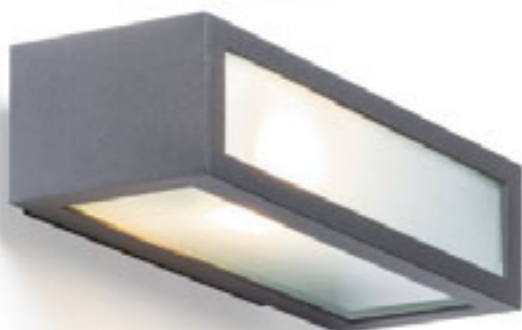

IP44

DURANT

Luminária retangular de parede para exterior com iluminação bidirecional para fontes de luz economizadoras de energia E27.

DURANT UP - DOWN NA PAREDE

230 V E27 18 W IP54

R12559 cinzento antracite

€ 120

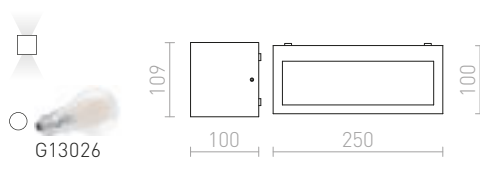

DURANT

Luminária de parede exterior com fontes de luz economizadoras de energia E27 para iluminação ambiente.

DURANT NA PAREDE

230 V E27 18 W IP54

R12568 cinzento prata

€ 98

R12569 cinzento antracite

€ 120

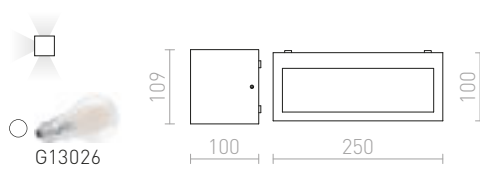

GINO

Luminária de parede para uso exterior com coberturas de vidro acetinado. Dimensões da base A/L/C 2/6/20cm.

GINO NA PAREDE

230 V E27 18 W IP44

R10387 cinzento antracite

€ 120

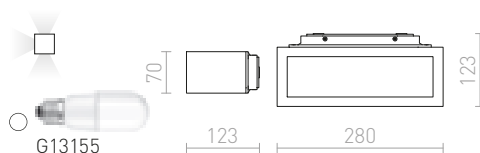







IP54

DELTA

Luminária de parede exterior adequada para terraços e entradas, para fontes de luz de baixo consumo energético GX53 ou E27.

DELTA 145 DE SUPERFÍCIE

230 V GX53 9 W IP54

R12563 cinzento antracite

€ 48

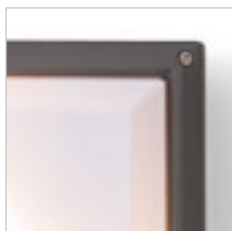
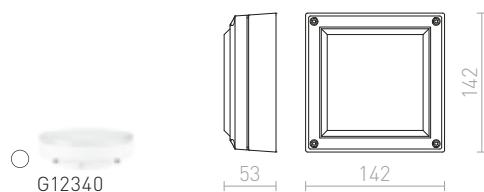

IP54

DELTA 215 DE SUPERFÍCIE

230 V E27 18 W IP54

R12564 cinzento antracite

€ 88

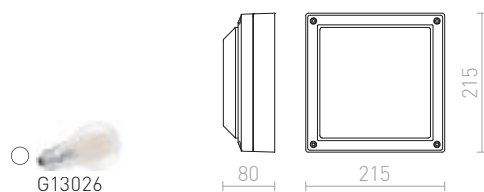

IP54

DELTA

Luminária de parede exterior adequada para terraços e entradas, para fontes de luz de baixo consumo energético GX53 ou E27.

DELTA 145 NA PAREDE

230 V GX53 9 W IP54

R12565 cinzento antracite

€ 48

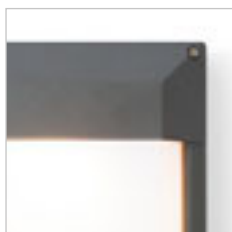
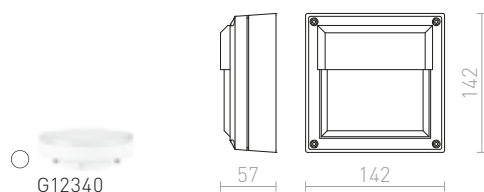

IP54

DELTA 215 NA PAREDE

230 V E27 18 W IP54

R12566 cinzento antracite

€ 88

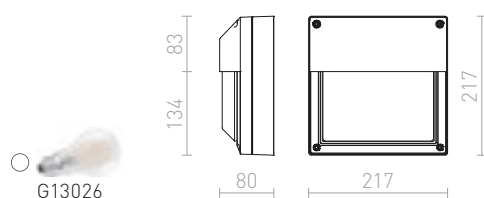

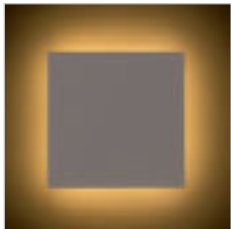

IP54

ATHI

Luminária de parede quadrada com LED integrado para iluminação indireta refletindo a luz da parede. Adequada para uso interior e exterior.

ATHI NA PAREDE

230 V LED 9,6 W 3000 K 550 lm Ra 80 IP54

R12551 branco

€ 120

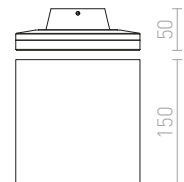

IP54

VERIA

Aplique fino de exterior com LED integrado.

VERIA NA PAREDE

230 V LED 6 W $\angle 116^\circ$ 3000 K 629 lm Ra 80 IP54

R11169 cinzento prata

€ 120 %

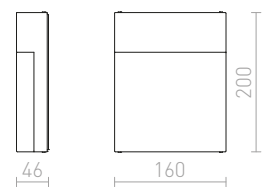



IP54

DELTA

Luminária de parede exterior adequada para iluminação geral, para fontes de luz economizadoras de energia E27.

DELTA RC NA PAREDE

230 V E27 18 W IP54

R12567 cinzento antracite

€ 78

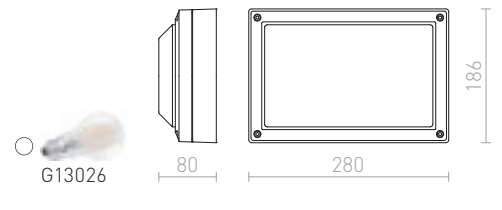

IP54

ASPEN

Luminária LED de exterior feita de alumínio fundido com difusor de opala para montagem em teto ou parede.

ASPEN DE SUPERFÍCIE

230 V LED 5 W 3000 K 247 lm Ra 80 IP54

R12011 cinzento prata

€ 58

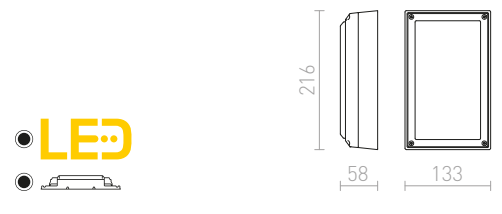

IP44

CHICAGO

Luminária exterior feita de alumínio fundido com difusor acrílico de cor opala. Para fontes de luz economizadoras de energia E27.

CHICAGO NA PAREDE

230 V E27 18 W IP44

R12018 cinzento antracite

€ 68







IP54

HIDE

Aplique de exterior com casquilho E27. Iluminação suave adequada para terraços e entradas.

HIDE RC NA PAREDE

230 V E27 18 W IP54

R12561 cinzento antracite

€ 98

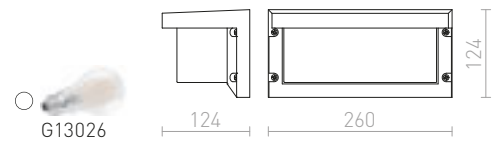

IP44

HIDE SQ NA PAREDE

230 V E27 13 W IP44

R12560 cinzento antracite

€ 88

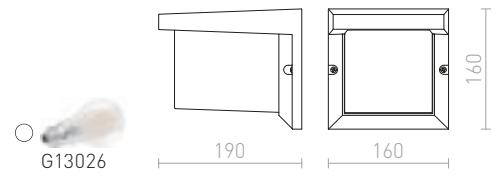

IP65

ANDANTE

Aplique de teto com LED embutido, adequado para iluminação de terraços ou entradas domésticas.

ANDANTE NA PAREDE

230 V LED 21 W 3000 K 1200 lm Ra 80 IP65

R13504 cinzento antracite/acrílico fosco

€ 150

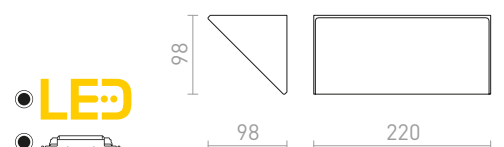



IP54

TAPA

Luminária de parede retangular para exterior em metal lacado, bidirecional LED.

TAPA NA PAREDE

230 V LED 6 W 3000 K 277 lm Ra 80 IP54

R13562 branco

€ 78 →

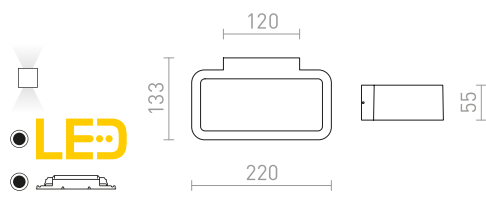

IP54

VECINO

Aplique de exterior em alumínio fundido com cobertura inferior de opala.

VECINO NA PAREDE

230 V LED 5 W 3000 K 330 lm Ra 80 IP54

R10351 cinzento prata

€ 58 %

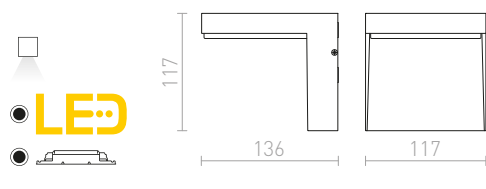

IP65

CHLOE

Aplique retangular em aço inoxidável, para iluminação indireta de uso interior ou exterior.

CHLOE NA PAREDE

230 V LED 9 W 3000 K 800 lm Ra 80 IP65

R11752 aço inoxidável

€ 120 %

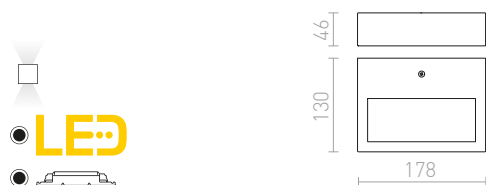

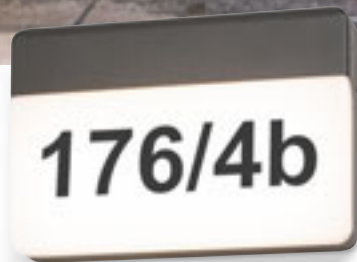
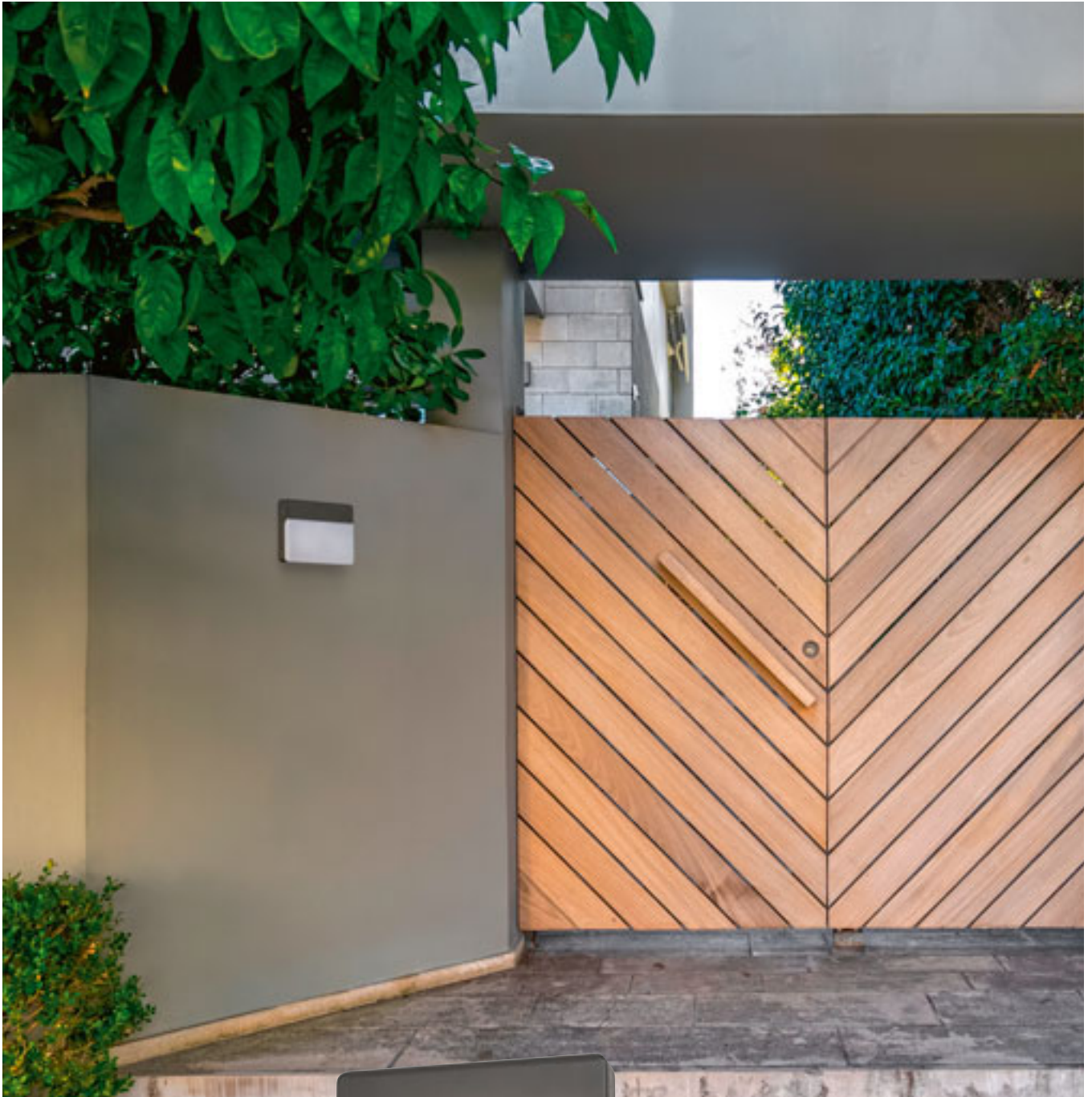

IP65

GAVIN

Candeiro de parede LED plano para exterior adequado para iluminar portas de entrada, corredores ou escadas. A luminária também é adequada para afixar números ou outros símbolos (não fornecidos).

GAVIN NA PAREDE

230 V LED 13 W 3000 K 650 lm Ra 80 IP65

R13756 cinzento antracite/acrílico fosco

€ 129 **NEW**

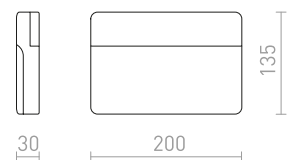



COMODO

Foco com LED embutido para iluminação descendente.

COMODO NA PAREDE

230 V LED 20 W 3000 K 940 lm Ra 80 IP65

R13512 cinzento antracite

€ 150

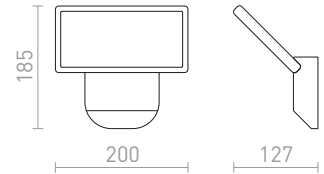

VIRGO

Aplique LED de exterior com cobertura de cor opala. Para iluminação descendente.

VIRGO NA PAREDE

230 V LED 9 W 3000 K 800 lm Ra 80 IP65

R11946 cinzento antracite

€ 98

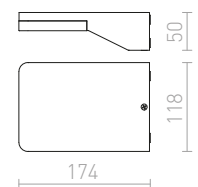
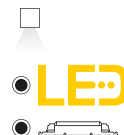



IP65

TWIST

Iluminação LED de parede em alumínio para exterior com a opção de definir a iluminação descendente ou como iluminação indireta ascendente.

TWIST NA PAREDE

230 V LED 12 W 3000 K 980 lm Ra 80 IP65

R13615 branco

€ 120

R13616 cinzento antracite

€ 120

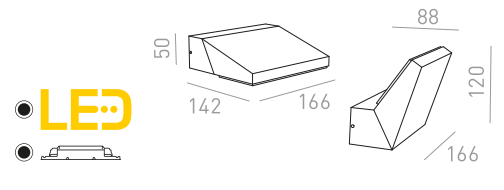

IP54

XYLO

Aplique de exterior LED para iluminação descendente.

XYLO NA PAREDE

230 V LED 8 W 3000 K 590 lm Ra 80 IP54

R12562 cinzento antracite

€ 129

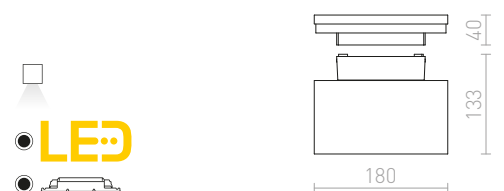



IP44



TELO

Luminária bidirecional de parede ao ar livre com painel de vidro transparente.

TELO NA PAREDE

230 V G9 40 W IP44

R10554 cinzento antracite

€ 68

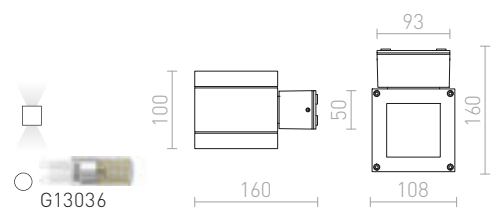

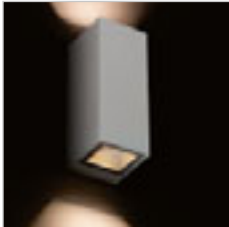

IP44

DESMOND

Candeeiro de parede em alumínio para exterior com iluminação bidirecional para duas fontes de luz LED com casquilho GU10.

DESMOND II NA PAREDE

230 V GU10 2x35 W IP44

R13609 branco

€ 68

R13610 cinzento prata

€ 68

R13611 cinzento antracite

€ 68

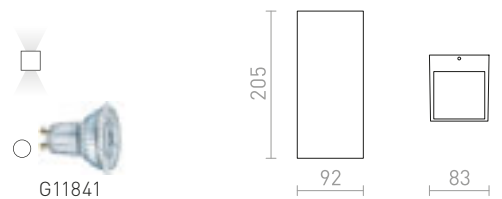

IP54

CABOX

Aplique de exterior com casquilho E27 e iluminação bidirecional.

CABOX II NA PAREDE

230 V E27 70 W IP54

R10384 cinzento antracite

€ 88

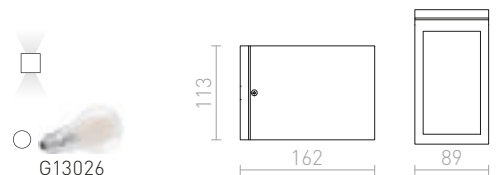



IP65



IP65

TITO

Luminária de parede LED para iluminação direcional com possibilidade de configurar o feixe de luz. Regulação da intensidade da luz TRIAC.

TITO R DIMM NA PAREDE

230 V LED 2x3 W 3000 K 500 lm Ra 80 IP65

R13736 branco

€ 88

NEW

R13737 preto

€ 88

NEW

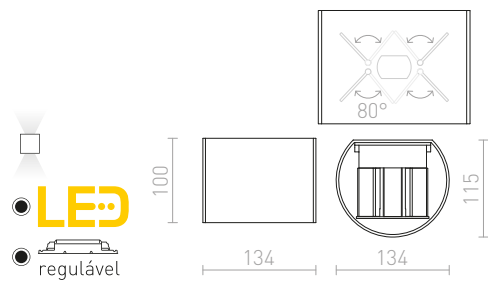

TITO SQ DIMM NA PAREDE

230 V LED 2x3 W 3000 K 500 lm Ra 80 IP65

R13738 branco

€ 78

NEW

R13739 preto

€ 78

NEW

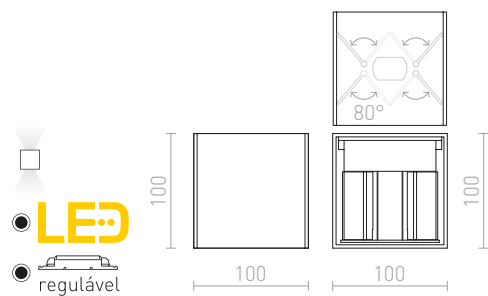



IP54

CARRE

Luminária de parede angular com LED integrado para iluminação bidirecional, com possibilidade de configurar feixe de luz.

CARRE NA PAREDE

230 V LED 2x3 W 3000 K 200 lm Ra 80 IP54

R12556 branco

€ 98

R12557 cinzento antracite

€ 98

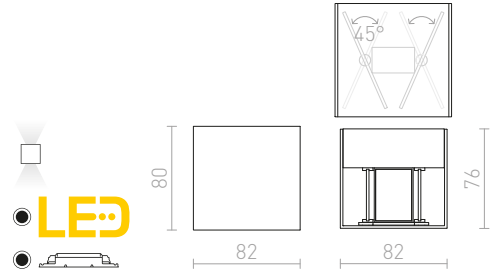

IP54

TITO

Luminária de parede LED para iluminação bidirecional com possibilidade de configurar o feixe de luz.

TITO SQ NA PAREDE

230 V LED 6 W 3000 K 500 lm Ra 80 IP54

R12601 alumínio escovado

€ 78

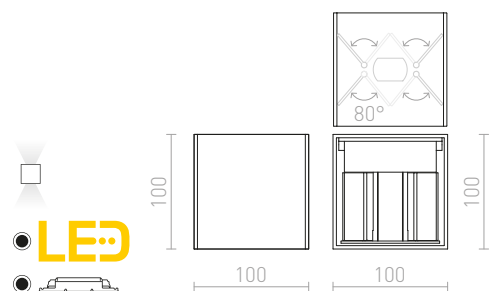





GRANITA

Candeeiro em cimento de parede, para exterior e fontes de luz LED com casquilho GU10.

GRANITA II NA PAREDE

230 V LED GU10 2x5 W IP65

R13792 cimento/granito claro

€ 120 **NEW**

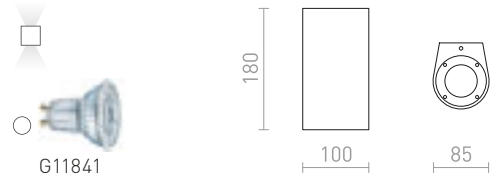

IP65



KANE

Candeeiro em cimento de parede para exterior, fontes de luz LED com casquilho GU10.

KANE I NA PAREDE

230 V LED GU10 5 W IP65

R13793 cimento/granito escuro

€ 88 **NEW**

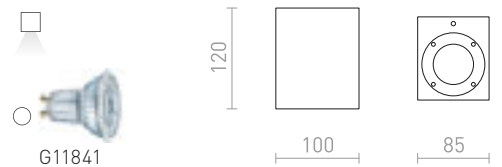

IP65

KANE II NA PAREDE

230 V LED GU10 2x5 W IP65

R13794 cimento/granito escuro

€ 120 **NEW**

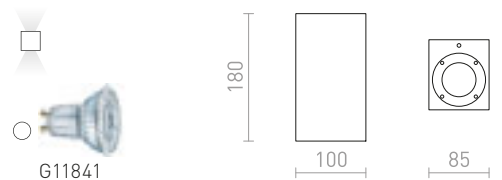



IP54



IP65

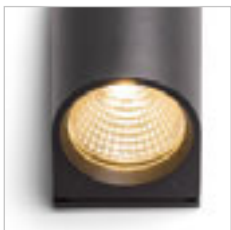

PIA

Aplique de exterior LED bidirecional em alumínio fundido.

PIA NA PAREDE

230 V LED 2x3 W 3000 K 270 lm Ra 80 [IP54](#)

R12010 cinzento antracite

€ 68

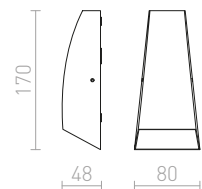
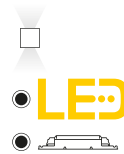

ZAZA

Luminária de parede de exterior com cobertura transparente.

ZAZA NA PAREDE

230 V LED 3,3 W 3000 K 250 lm Ra 80 [IP65](#)

R10398 cinzento antracite

€ 88

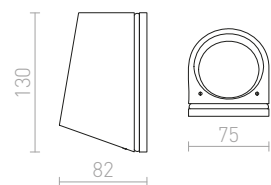
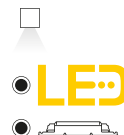



IP65

GIGI

Aplique de exterior com proteção de vidro.

GIGI NA PAREDE

230 V LED 3,3W 3000 K 250 lm Ra 80 IP65

R10399 cinzento antracite

€ 98

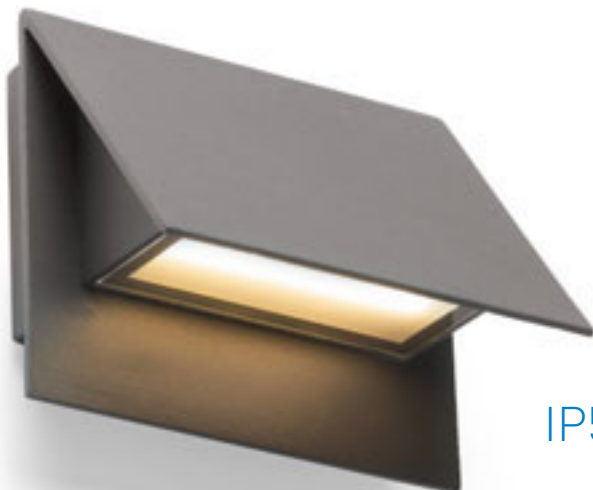
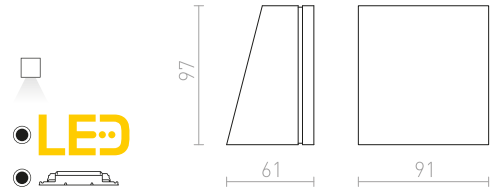

IP54

GERI

Luminária LED em alumínio para exterior com iluminação embutida.

GERI NA PAREDE

230 V LED 5W 3000 K 211 lm Ra 80 IP54

R13561 cinzento antracite

€ 98

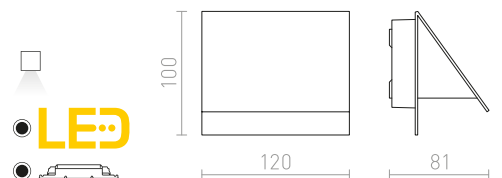

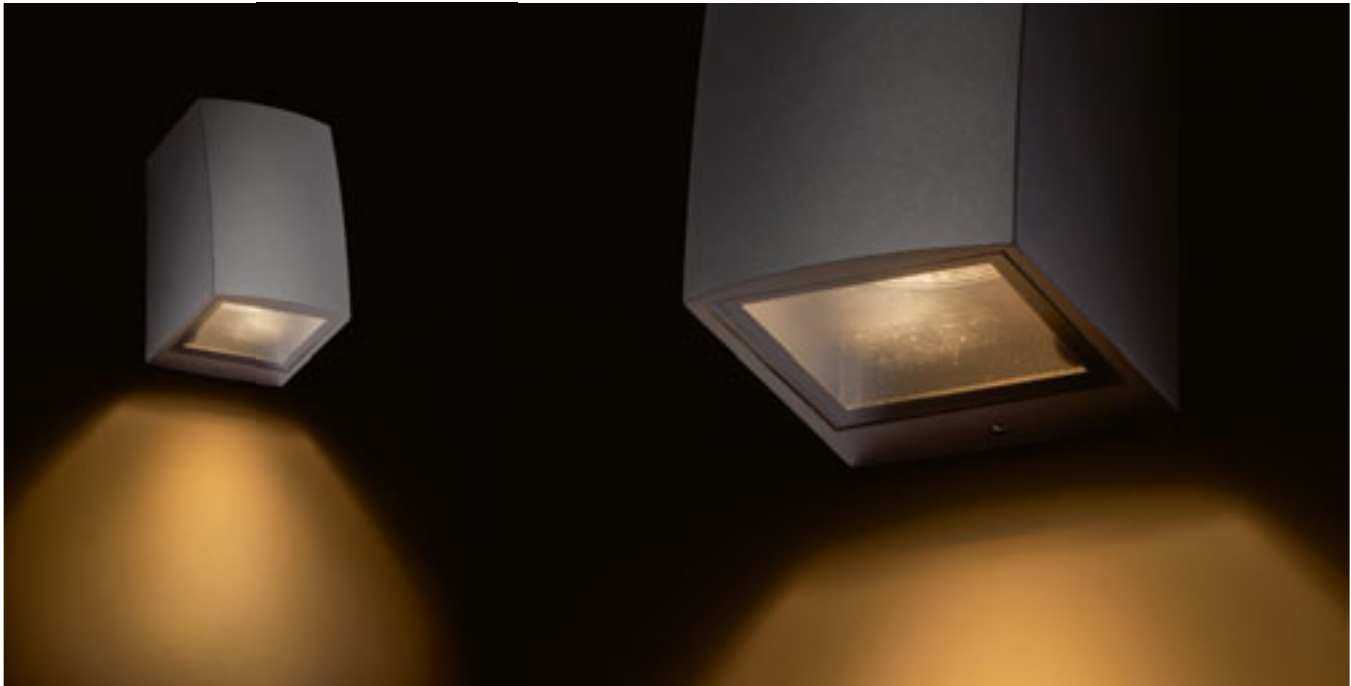

IP54

SELMA

Foco de alumínio de exterior com um casquilho GU10.

SELMA NA PAREDE
230 V GU10 35 W IP54

R13513 branco	€ 38
R13514 cinzento prata	€ 38
R13515 cinzento antracite	€ 38

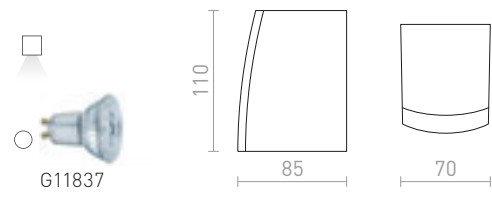

IP54

SIV

Candeeiro de teto redondo com LED embutido e iluminação descendente. Adequado para corredores.

SIV SUPERFÍCIE
230 V LED 6 W $\angle 120^\circ$ 3000 K 360 lm Ra80 IP54

R13502 cinzento antracite	€ 88
----------------------------------	------

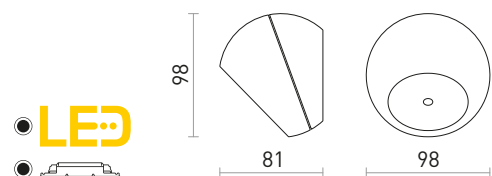



IP54



BOURDON

Candeiro de parede exterior com suporte para fontes de luz GU10. O corpo é em alumínio fundido pintado.

BOURDON NA PAREDE

230 V GU10 35 W IP54

R13559 cinzento antracite

€ 48

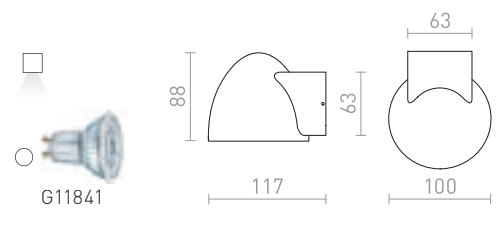

IP54



PIPER

Aplique LED tubular para exterior com iluminação embutida.

PIPER NA PAREDE

230 V LED 6 W 3000 K 489 lm Ra 80 IP54

R13560 cinzento antracite

€ 88

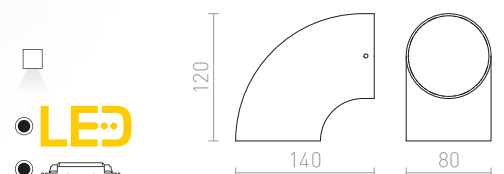



IP54



MIDZACK

Aplique arredondado com LED integrado para iluminação bidirecional.

MIDZACK NA PAREDE

230 V LED 2x3 W 3000 K 480 lm Ra 80 IP54

R12585 branco

€ 88

R12586 preto

€ 88

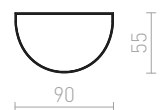
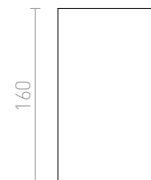
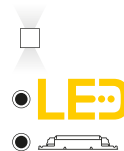



IP54



IP54

ZACK

Luminária LED de parede exterior em alumínio pressurizado.

ZACK II

230 V LED 2x3 W $\angle 58^\circ$ 3000 K 315 lm Ra 80 IP54

R12022 cinzento antracite

€ 78

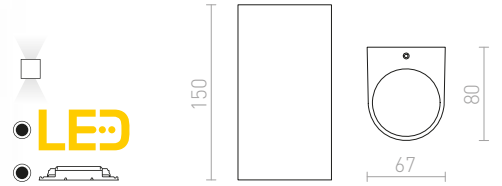

ZACK I

230 V LED 3 W $\angle 58^\circ$ 3000 K 176 lm Ra 80 IP54

R12027 cinzento antracite

€ 58

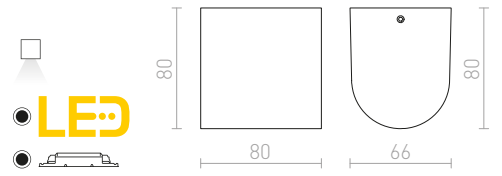

IP65



BEJA

Lâmpada bidirecional de parede exterior em alumínio fundido. A luminária está equipada com LEDs de alta potência.

BEJA II NA PAREDE

230 V LED 2x9 W $\angle 24^\circ$ 3000 K 670 lm Ra 80 IP65

R13757 cinzento antracite

€ 150

NEW

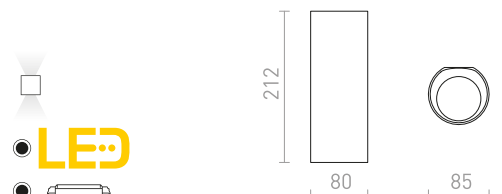



IP54

KUBI

Luminária LED de parede para exteriores em alumínio pressurizado.

KUBI I

230 V LED 3 W $\angle 56^\circ$ 3000 K 176 lm Ra 80 IP54

R12021 cinzento antracite

€ 58

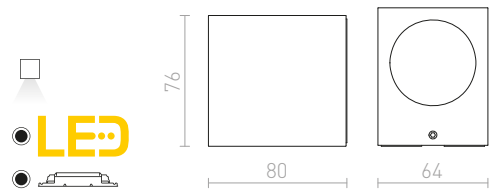

IP54

KUBI II

230 V LED 2x3 W $\angle 56^\circ$ 3000 K 315 lm Ra 80 IP54

R12028 cinzento antracite

€ 78

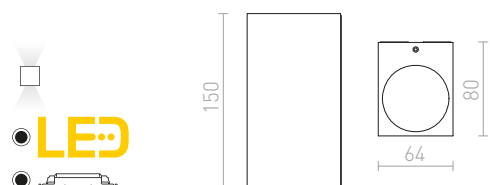

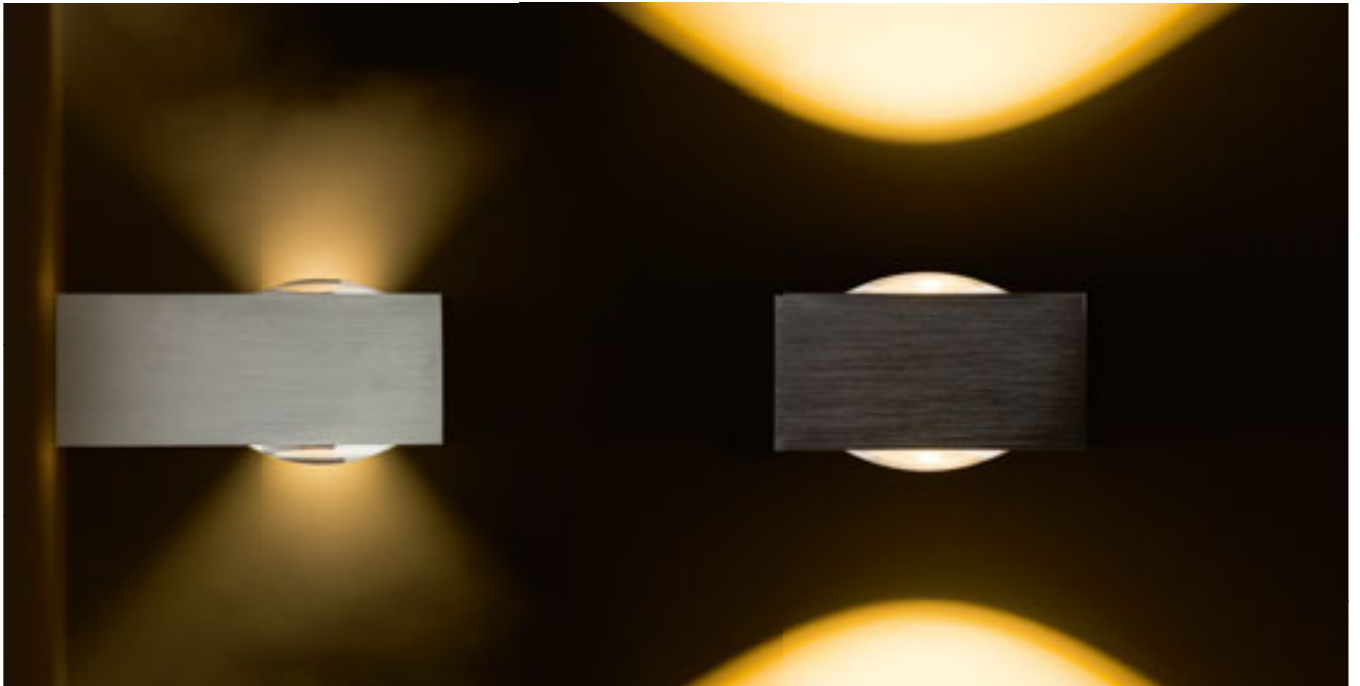

IP54



IP54



KORSO

Aplique com LED integrado para interiores e exteriores. Feito de alumínio com acabamento anodizado natural ou preto escovado.

KORSO II NA PAREDE

230 V LED 2x3 W $\angle 120^\circ$ 3000 K 780 lm Ra 80 IP54

R12831 alumínio escovado € 78 %

R12832 anodizado negro € 98 %

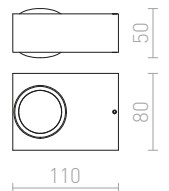

KORSO I NA PAREDE

230 V LED 5 W $\angle 120^\circ$ 3000 K 390 lm Ra 80 IP54

R12829 alumínio escovado € 68 %

R12830 anodizado negro € 78 %

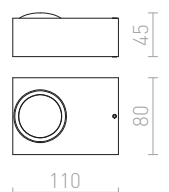
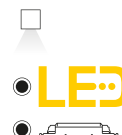

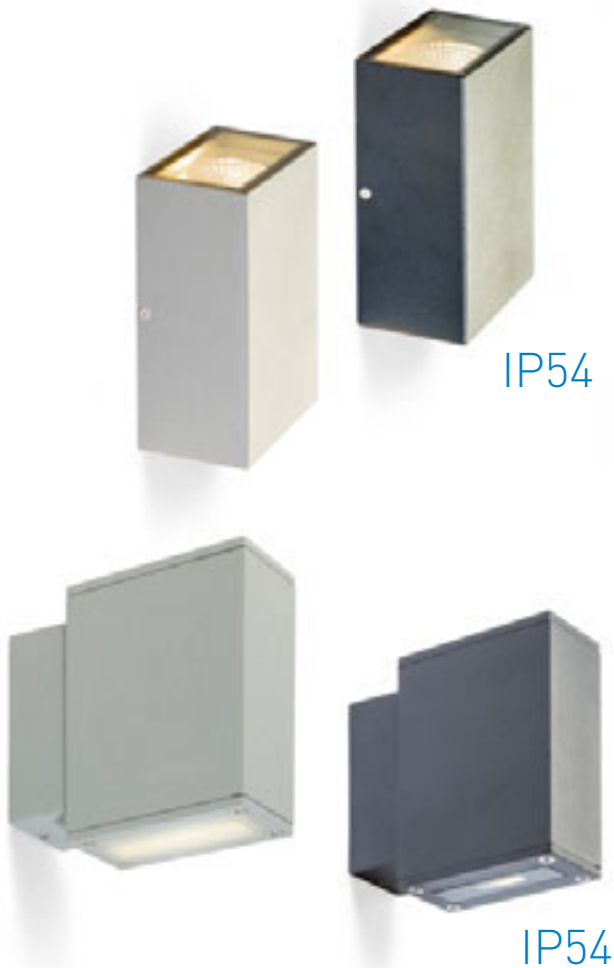

DIXIE

Luminária de parede para exterior com LED integrado, de alumínio fundido para iluminação bidirecional.

DIXIE 10x16 NA PAREDE

230V LED 2x5W $\angle 84^\circ$ 3000 K 550 lm Ra 80 IP54

R10352 branco

€ 78

%

R10353 preto

€ 98

%

R10354 cinzento prata

€ 78

%

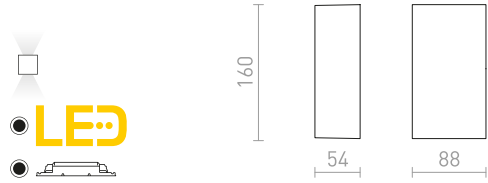

DIXIE 4x12 NA PAREDE

230V/700mA LED 2x3W $\angle 48^\circ$ 3000 K 360 lm Ra 80 IP54

R10355 preto

€ 98

→

R10356 cinzento prata

€ 58

%

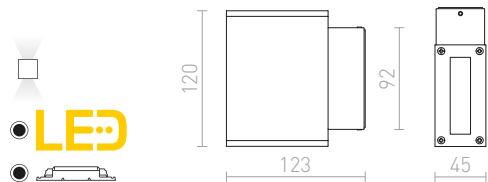

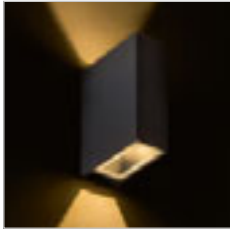

IP54

UKKO

Aplique retangular para exteriores com LED integrado, para iluminação bidirecional.

UKKO NA PAREDE

230 V LED 2x3 W $\angle 55^\circ$ 3000 K 180 lm Ra 80 IP54

R12555 preto

€ 120

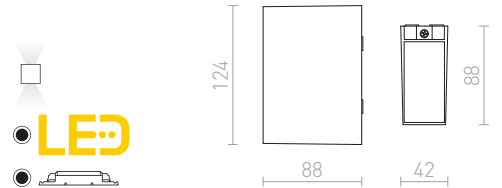

IP54

PEKKO

Aplique retangular para exteriores com LED integrado para iluminação unidirecional.

PEKKO NA PAREDE

230 V LED 3 W $\angle 67^\circ$ 3000 K 86 lm Ra 80 IP54

R12552 branco

€ 88

R12553 preto

€ 88

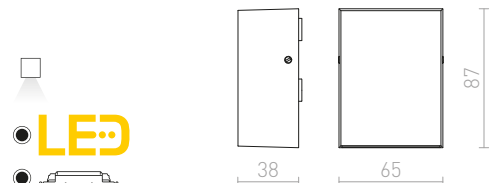

IP54

NICK

Aplique com LED integrado e iluminação bidirecional adequado para interiores e exteriores.

NICK II NA PAREDE

230 V LED 2x3 W $\angle 10^\circ$ 3000 K 780 lm Ra 80 IP54

R12827 alumínio escovado

€ 68

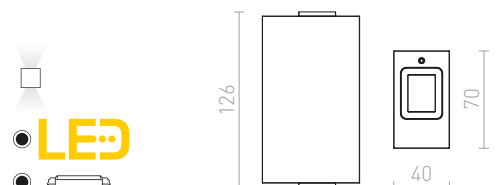



IP54

ZANE

Tubo LED minimalista montado em uma base quadrada com iluminação bidirecional adequado para uso externo.

ZANE NA PAREDE

230 V LED 2x3 W $\angle 60^\circ$ 3000 K 300 lm Ra 80 IP54

R12960 níquel mate

€ 68 %

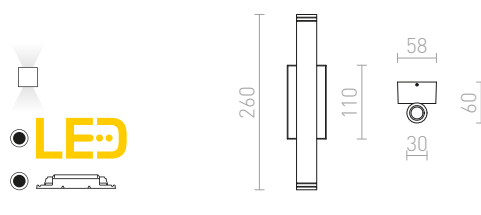

IP54

MICO

Aplique de alumínio fundido com foco fixo para iluminação unidirecional.

MICO I

230 V GU10 35 W IP54

R10170 alumínio

€ 58 %

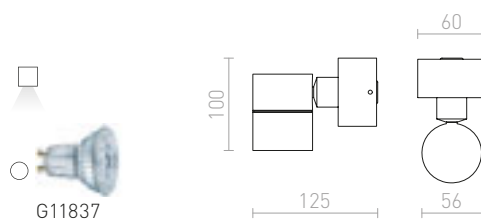



IP54



IP54

MOIRE

Aplique de alumínio natural com coberturas de vidro.

MOIRE I

230 V GU10 35 W IP54

R10133 alumínio

€ 58 %

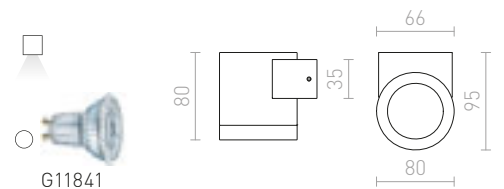

MOIRE II EXTERIOR

230 V G9 25 W IP54

R10132 alumínio

€ 68 %

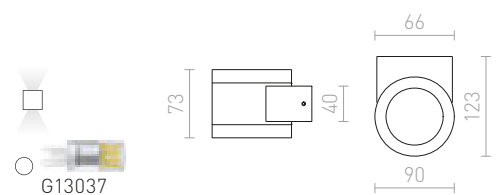



IP54

MORA

Luminária de parede para uso exterior com iluminação suave, adequada para terraços e entradas de habitação, com casquilho E27.

MORA NA PAREDE

230 V E27 18 W IP54

R12571 cinzento prata

€ 58 %

R12572 cinzento antracite

€ 68 %

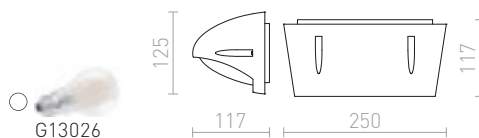

IP54

LESA

Luminária de alumínio pressurizado para exterior montada em parede, disponível em três cores.

Uma placa de cobertura de metal está incluída, se a iluminação descendente for tudo o que for necessário.

LESA NA PAREDE

230 V E27 26 W IP54

R10364 preto

€ 98

R10365 branco

€ 98

R10366 cinzento prata

€ 98

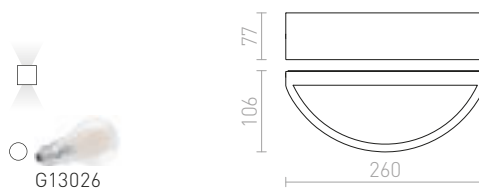



IP54



IP54

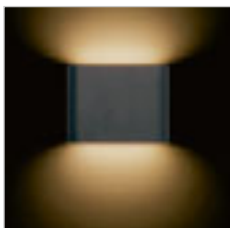

CHOIX

Aplique LED bidirecional de exterior em alumínio fundido.

CHOIX 114 NA PAREDE

230 V LED 2x3 W 3000 K 318 lm Ra 80 IP54

R12012 cinzento antracite

€ 68



LED

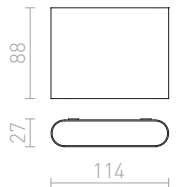

CHOIX 175 NA PAREDE

230 V LED 10 W 3000 K 660 lm Ra 80 IP54

R12691 cinzento antracite

€ 88



LED

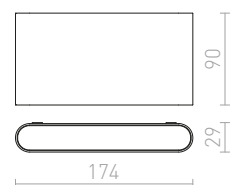



IP65



FOX

Foco de LED ajustável para uso exterior com cobertura de vidro transparente para montagem em parede. Para instalação em jardim, é possível montar com estaca no solo (R11755).

FOX REFLETOR EXTERIOR

230 V LED 9 W $\angle 120^\circ$ 3000 K 900 lm Ra 80 IP65

R11753 cinzento antracite

€ 178

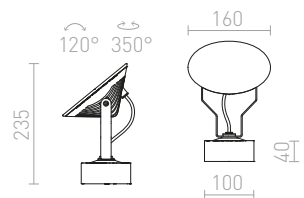

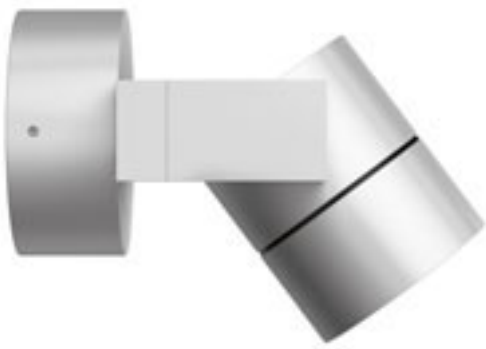

IP44



ORIT

Foco inclinável em alumínio para exterior equipado com LED de 6W. Luz inclinável em apenas um eixo.

ORIT NA PAREDE

230 V LED 6 W $\angle 80^\circ$ 3000 K 315 lm Ra 80 IP44

R12033 alumínio

€ 88

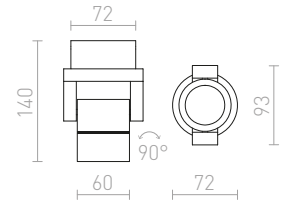

IP54

DIREZZA

Foco exterior com refletor que pode inclinar soltando um parafuso entre o refletor e a base.

DIREZZA NA PAREDE

230 V GU10 35 W IP54

R10388 cinzento prata

€ 68

R10432 cinzento antracite

€ 58



G11837

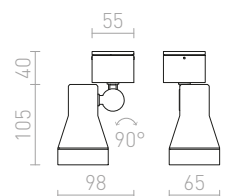





IP54

BORA

Foco LED quadrado de exterior para montagem em parede.

BORA NA PAREDE

230 V LED 6 W $\angle 44^\circ$ 3000 K 355 lm Ra 80 IP54

R12578 cinzento antracite

€ 98

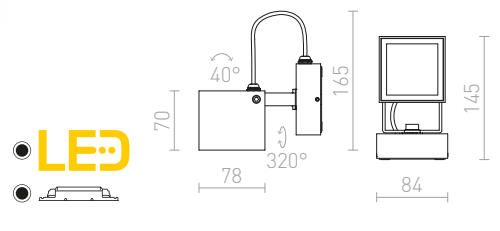

IP54

PONTA

Holofote plano e preto com LED integrado. O cabo é fornecido sem ficha.

PONTA COM SENSOR

230 V LED 30 W $\angle 120^\circ$ 3000 K 2700 lm Ra 80 IP54

R12982 preto

€ 78

%

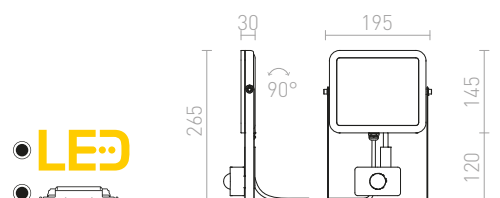



IP65

BLUESTAR

Foco externo de alumínio com espigão para fonte de luz LED com casquilho GU10, moldura frontal em aço inoxidável. Inclui cabo principal de 1m, sem ficha incluída.

BLUESTAR COM ESPIGÃO

230 V GU10 35 W IP65

R13630 cinzento antracite

€ 78

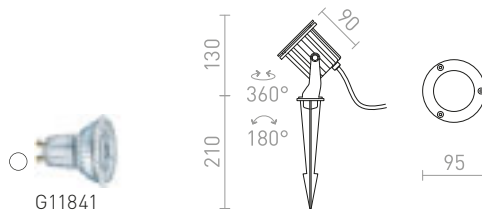

IP65

GUN

Foco projetor LED de exterior com estaca no solo. Inclui um cabo principal de 1m, sem ficha incluída.

GUN COM ESPIGÃO

230 V LED 3x1 W $\angle 30^\circ$ 3000 K 210 lm Ra 80 IP65

R10530 preto

€ 48

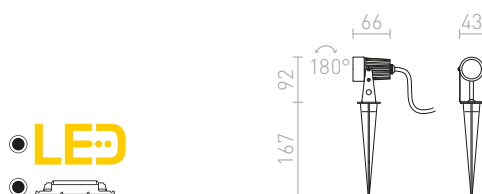



IP54

DIREZZA

Foco exterior com refletor que pode inclinar soltando um parafuso entre o refletor e a base.

DIREZZA COM ESPIGÃO

230 V GU10 35 W IP54

R10427 cinzento prata

€ 58

R10431 cinzento antracite

€ 68



IP54

CORDOBA

Foco de exterior sobre estaca com fonte de luz GU10. Fornecido com um cabo de 1m, sem ficha incluída.

CORDOBA COM ESPIGÃO

230 V GU10 35 W IP54

R12579 cinzento antracite

€ 68

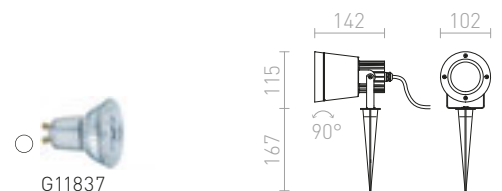



IP65

LORCA

Mini foco LED para exterior com espigão para o solo. Inclui cabo de alimentação de 1m, sem ficha incluída.

LORCA COM ESPIGÃO

230 V LED 5W 3000 K 316 lm Ra 80 IP65

R13568 cinzento antracite

€ 120

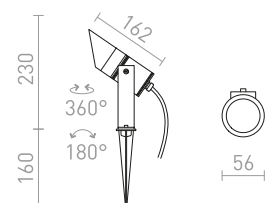



IP65

GARY

Foco LED exterior sobre estaca no chão. Inclui cabo principal de 1m, sem ficha incluída.

GARY LED COM ESMIGÃO

230 V LED 10 W $\angle 45^\circ$ 3000 K 900 lm Ra 80 IP65

R10527 cinzento

€ 98

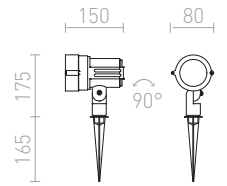

IP54

BORA

Foco LED quadrado de exterior. Inclui cabo de ligação de 1m, sem ficha incluída.

BORA COM ESMIGÃO

230 V LED 6 W $\angle 50^\circ$ 3000 K 340 lm Ra 80 IP54

R12025 cinzento antracite

€ 98

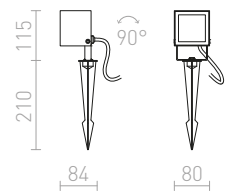

IP65

COSMO

Foco LED de exterior com estaca no solo. Fornecido com um cabo, sem ficha incluída.

COSMO COM ESMIGÃO

230 V LED 10 W $\angle 24^\circ$ 3000 K 850 lm Ra 80 IP65

R12580 cinzento antracite

€ 98

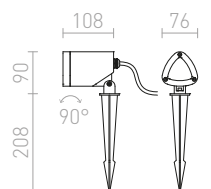



IP65

HEAVY DUTY

Refletor de exterior de alumínio sólido. A luminária é fornecida com um cabo de 1,5 m, sem ficha incluída. Possibilidade de completar com estaca para o solo (R11755).

HEAVY DUTY REFLETOR EXTERIOR

230 V GU10 50 W IP65

R11948 cinzento antracite

€ 68

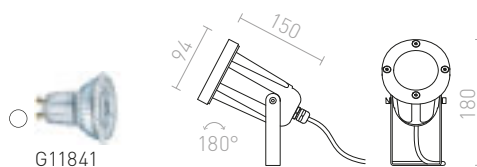

IP65

FOX

Foco de LED ajustável para uso exterior com cobertura de vidro transparente para montagem em parede. Para instalação em jardim, é possível montar com estaca no solo (R11755).

FOX REFLETOR EXTERIOR

230 V LED 9 W $\angle 120^\circ$ 3000 K 900 lm Ra 80 IP65

R11753 cinzento antracite

€ 178

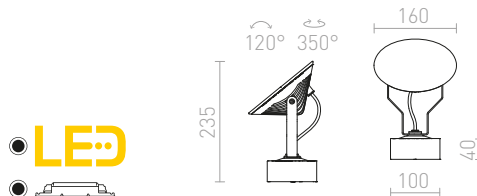

IP65

ROSS

Foco exterior de LED ajustável com cobertura de vidro acetinado e escolha de ângulo de luz de 8-30 °. Para instalação em jardim, é possível montar com uma estaca no solo (R11755). Fornecido sem cabo de alimentação.

ROSS REFLETOR EXTERIOR

230 V LED 9 W $\angle 30^\circ$ 3000 K 900 lm Ra 80 IP65

R11754 cinzento antracite

€ 178

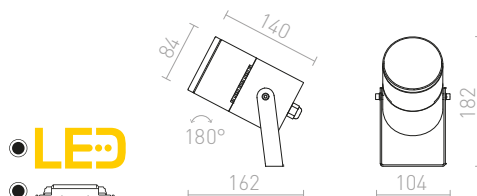



ESPIGÃO

Espiga universal para luminárias exteriores. O ponto pode ser fixado no casquilho M10 * 1 ou preso por um parafuso no suporte.

ESPIGÃO UNIVERSAL PARA SOLO

R11755 preto

€ 12

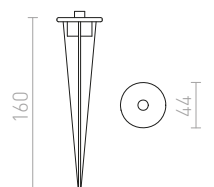



IP67



IP67

TOPTOP

Iluminação de solo LED com vigias para montagem em ladrilho sem necessidade de embutir.

TOPTOP S I

230 V LED 1,5 W 3000 K 105 lm Ra 80 IP67

R13617 cinzento antracite

€ 88

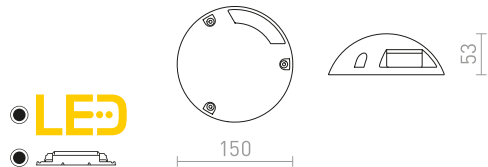

TOPTOP S III

230 V LED 3x1 W 3000 K 210 lm Ra 80 IP67

R13618 cinzento antracite

€ 88

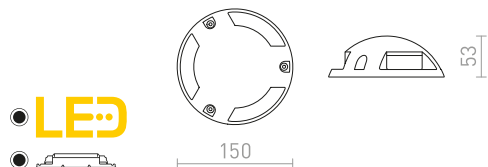



IP54

FAROS

Luminária de exterior LED de alumínio fundido que ilumina para os lados. Para montagem na parede ou no chão.

FAROS EXTERIOR

230 V LED 3 W 3000 K 154 lm Ra 80 IP54

R11963 cinzento antracite

€ 120

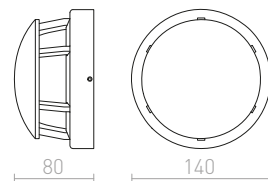

IP67



TOPTOP

Aplique de exterior com LED e quatro aberturas de visualização sem a necessidade de inserção. Para instalação em jardim, é possível montar com a estaca no solo (R11755).

TOPTOP IV SOLO

230 V LED 4x1 W 3000 K 400 lm Ra 80 IP67

R11751 cinzento antracite

€ 158

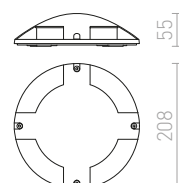

ESPIGÃO

Espiga universal para luminárias exteriores. O ponto pode ser fixado no casquilho M10 * 1 ou preso por um parafuso no suporte.

ESPIGÃO UNIVERSAL PARA SOLO

R11755 preto

€ 12

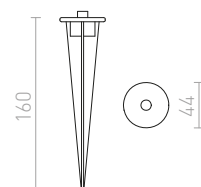



IP65

BOBO

Lâmpada LED de alumínio saliente para uso exterior, adequada para iluminação de caminhos e escadas, sem necessidade de embutir.

BOBO R NA PAREDE

230 V LED 3 W 3000 K 212 lm Ra 80 IP65

R13933 cinzento antracite

€ 58 **NEW**

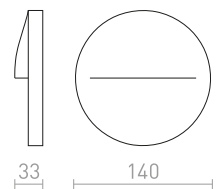
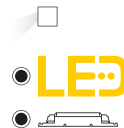



IP65

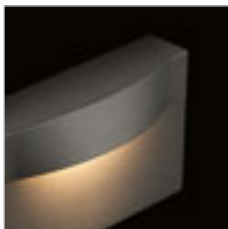

BOBO

Lâmpada LED de alumínio saliente para uso exterior; adequada para iluminação de caminhos e escadas, sem necessidade de embutir.

BOBO RC NA PAREDE

230V LED 8W 3000K 640lm Ra80 IP65

R13934 cinzento antracite

€ 58

NEW

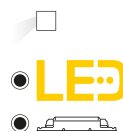
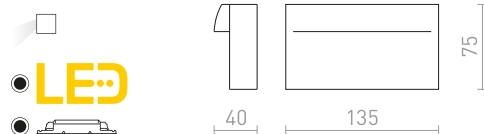

IP65

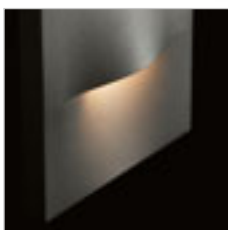

BOBO

Lâmpada LED de alumínio saliente para uso exterior; adequada para iluminação de caminhos e escadas, sem necessidade de embutir.

BOBO SQ NA PAREDE

230V LED 3W 3000K 135lm Ra80 IP65

R13935 cinzento antracite

€ 58

NEW

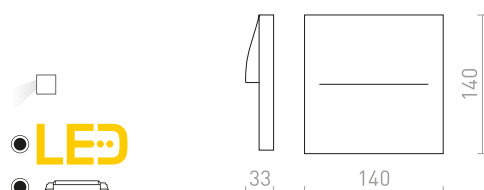



IP65

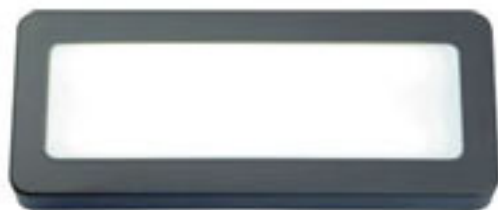

RENO

Aplique LED de exterior feito de plástico durável com driver.

RENO SQ DR DE SUPERFÍCIE

230 V LED 5 W 3000 K 450 lm Ra 80 IP65

R11951 cinzento

€ 48

R11954 cinzento antracite

€ 48

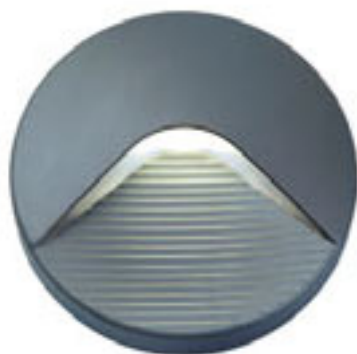
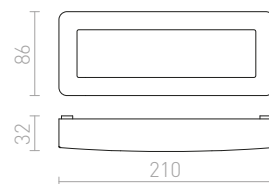

IP65

RENO

Aplique LED de exterior feito de plástico durável com driver. Disponível em duas cores. Instale apenas para iluminação descendente.

RENO R NA PAREDE

230 V LED 2 W 3000 K 180 lm Ra 80 IP65

R11949 cinzento

€ 38

R11952 cinzento antracite

€ 38

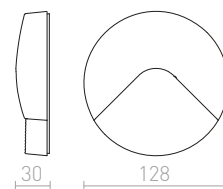
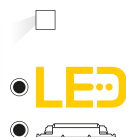

IP65

RENO SQ INDR NA PAREDE

230 V LED 3 W 3000 K 280 lm Ra 80 IP65

R11950 cinzento

€ 48

R11953 cinzento antracite

€ 48

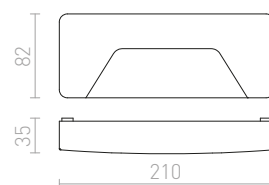
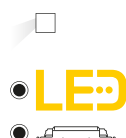





IP54



ITAKA

Luminária exterior de parede com luz descendente.
Adequada para iluminação de escadas e estradas.

ITAKA NA PAREDE

230 V LED 2 W 3000 K 180 lm Ra 80 IP54

R10379 cinzento prata

€ 78 %

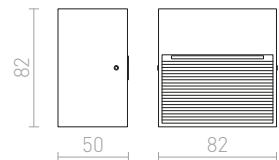
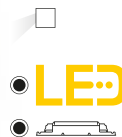

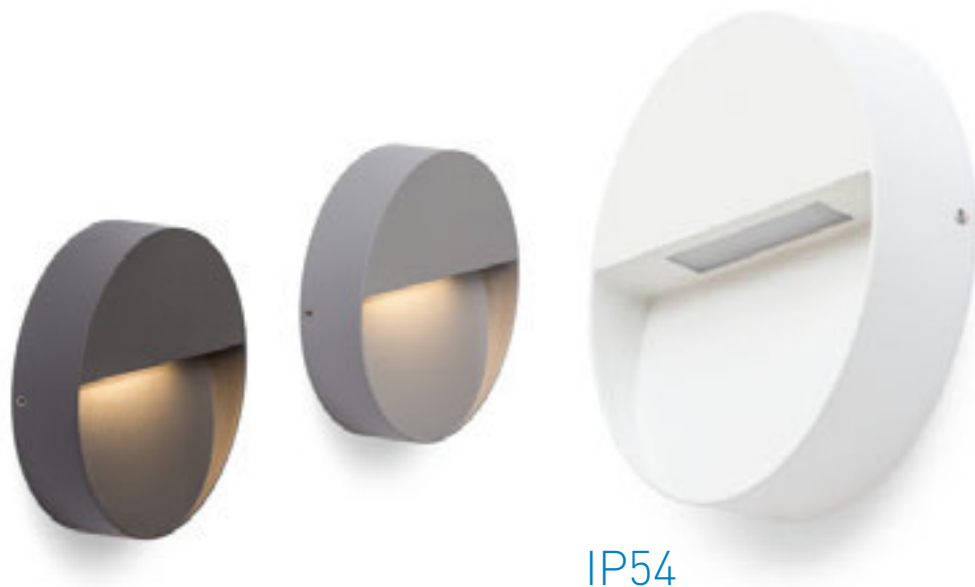

IP54

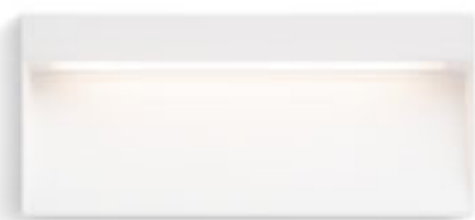

IP54



IP54



AQILA

Aplicação com LED integrado para iluminação de orientação de pavimentos, escadas ou terraços. Adequado para exterior e interior sem a necessidade de ser embutido.

AQILA R NA PAREDE

230 V LED 6 W 3000 K 200 lm Ra 80 IP54

R12539	branco	€ 88
R12540	cinzento	€ 78 %
R12541	cinzento antracite	€ 88

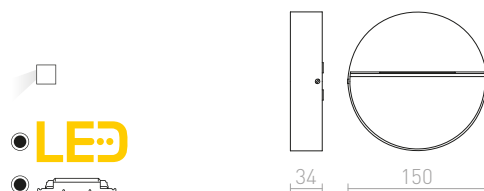

AQILA RC NA PAREDE

230 V LED 6 W 3000 K 200 lm Ra 80 IP54

R12545	branco	€ 88 %
R12547	cinzento antracite	€ 120

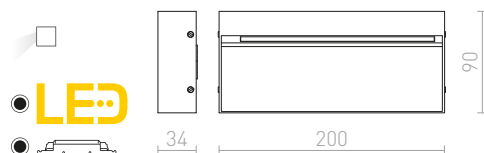

AQILA SQ NA PAREDE

230 V LED 6 W 3000 K 200 lm Ra 80 IP54

R12542	branco	€ 88
R12543	cinzento	€ 88
R12544	cinzento antracite	€ 88

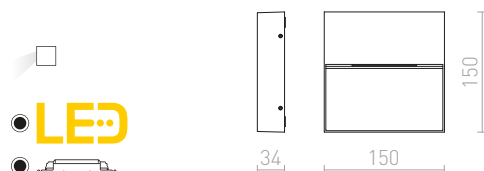





IP54



IP54



IP54



KICK

Luminária de orientação embutida com LED integrado que emite luz para um, dois ou três lados. Destina-se a instalações de parede.

KICK I EMBUTIDA

230 V LED 3 W 3000 K 100 lm Ra 80 IP54

R12613 branco

€ 58

R12615 preto

€ 58



KICK II EMBUTIDA

230 V LED 3 W 3000 K 120 lm Ra 80 IP54

R12616 branco

€ 58

R12617 alumínio escovado

€ 48

R12618 preto

€ 58

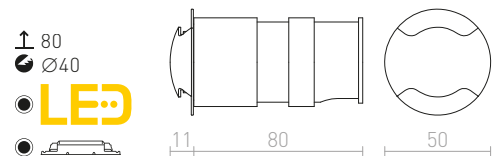

KICK III EMBUTIDA

230 V LED 3 W 3000 K 150 lm Ra 80 IP54

R12619 branco

€ 58

R12621 preto

€ 58

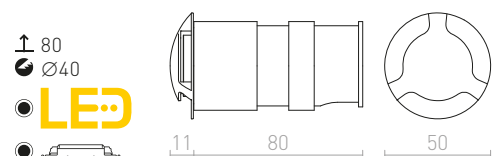



IP54



IP54



IP54



CLUB

Aplique LED adequado como luz de orientação para corredores e escadas.

CLUB IND EMBUTIDA

230 V LED 3 W 3000 K 270 lm Ra 80 IP54

R12686 cinzento prata

€ 48

⊥ 90
● Ø56



● LED

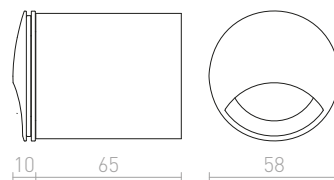

CLUB EMBUTIDA

230 V LED 3 W 3000 K 270 lm Ra 80 IP54

R12685 cinzento prata

€ 58

⊥ 90
● Ø57



● LED

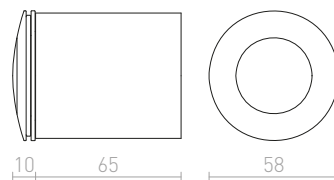

ELICA

Aplique LED embutido para exteriores com placa frontal de metal, para iluminação descendente. Caixa de montagem incluída.

ELICA R EMBUTIDA

230 V LED 3 W 3000 K 75 lm Ra 80 IP54

R12528 alumínio escovado

€ 68 %

⊥ 95
● Ø75



● LED

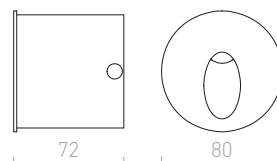



IP54

MARCO LED

Aplique redondo embutido, adequado para uso interior e exterior. Instale somente para iluminação descendente. Caixa de montagem incluída.

MARCO EMBUTIDA

230 V LED 3 W 3000 K 80 lm Ra 80 IP54

R12024 branco

€ 48

R12029 cinzento prata

€ 48

R12030 cinzento antracite

€ 48

↑ 60
⊗ Ø76



LED

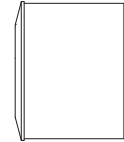

56

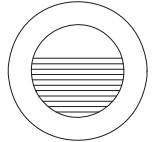

78



IP54

ASTERIA

Aplique embutido para uso externo. O quadro visível tem uma profundidade de 3 cm. Instale apenas para iluminação descendente.

ASTERIA EMBUTIDA

230 V LED 3 W 3000 K 180 lm Ra 80 IP54

R10558 cinzento prata

€ 68

↑ 75
⊗ Ø113



LED

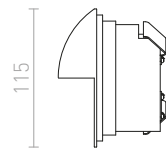

115

32 58

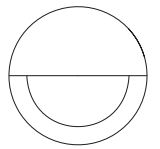

115



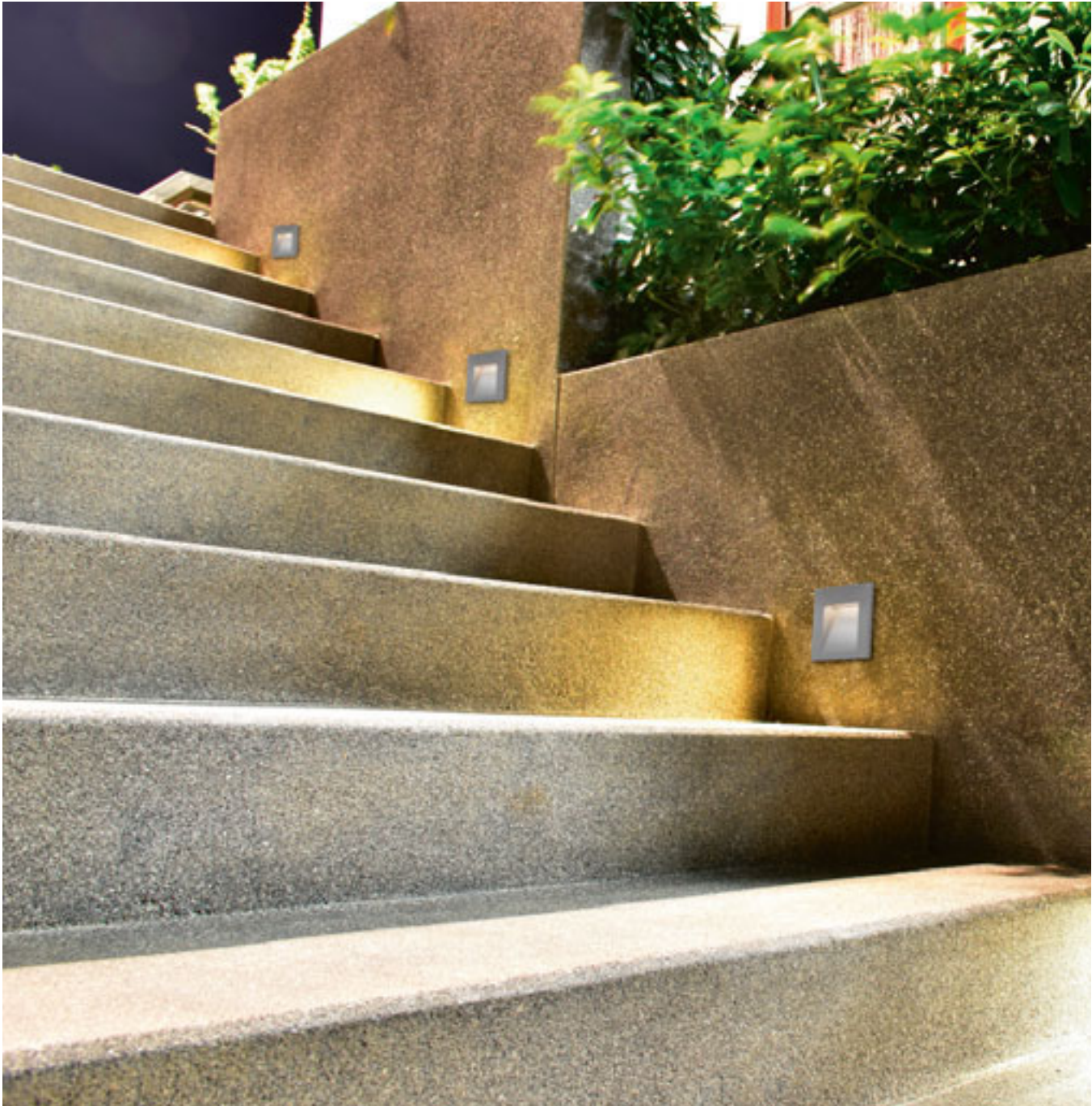

IP54

TESS

Aplique quadrado embutido adequado para uso interior e exterior. Instale apenas para iluminação descendente. Disponível em três cores diferentes. Caixa de montagem incluída.

TESS SQ EMBUTIDA

230 V LED 3 W 3000 K 80 lm Ra 80 IP54

R12013 branco € 58

R12014 cinzento prata € 58

R12015 cinzento antracite € 58

± 70
60x55



LED

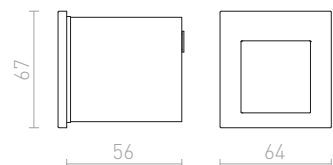



IP65



RASQ

Luminária embutida LED para uso interior e exterior. Adequada como iluminação de orientação de passeios, escadas ou terraços. Instale apenas para iluminação descendente.

RASQ EMBUTIDO NA PAREDE

230 V LED 9 W 3000 K 190 lm Ra 80 IP65

R12627 branco

€ 178

R12628 cinzento antracite

€ 178

↑ 80

▣ 237x77



● LED

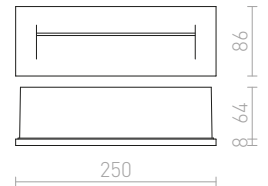

PER

Aplique LED adequado para uso interior e exterior como luz de orientação para corredores e escadas.

PER EMBUTIDA

230 V LED 3 W 3000 K 76 lm Ra 80 IP54

R12576 branco

€ 58

R12577 cinzento antracite

€ 58

↑ 60

▣ 65x102



● LED

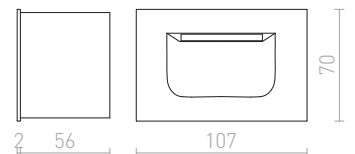

IP54



ELICA

Aplique LED embutido para exteriores com placa frontal de metal, para iluminação descendente. Caixa de montagem incluída.

ELICA SQ EXTERIOR

230 V LED 3 W 3000 K 180 lm Ra 80 IP54

R10639 níquel mate

€ 35

R12529 alumínio escovado

€ 68

↑ 70

⊘ Ø75



● LED

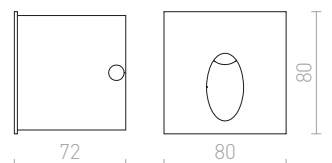

IP54



IP65



IP65



IP65



GORDIQ

Luminária embutida LED para iluminação direcional de pavimentos, escadas ou terraços. Apenas iluminação descendente.

GORDIQ S EMBUTIDA

230 V LED 1,5 W 3000 K 30 lm Ra 80 IP65

R12533 branco

€ 68

R12534 cinzento antracite

€ 68

↑ 60

75x72



LED

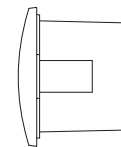

12 59

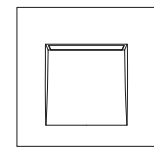

90

90

GORDIQ M EMBUTIDA

230 V LED 3 W 3000 K 90 lm Ra 80 IP65

R12535 branco

€ 88

R12536 cinzento antracite

€ 88

↑ 60

115x108



LED

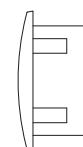

15 60

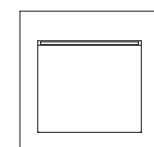

140

140

GORDIQ L EMBUTIDA

230 V LED 3 W 3000 K 90 lm Ra 80 IP65

R12537 branco

€ 78

R12538 cinzento antracite

€ 78

↑ 60

115x50



LED

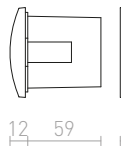

12 59

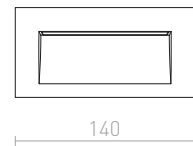

70

140



IP65

RAGG

Iluminação de embutir para exterior com luz direcional para iluminar calçadas e escadas.

RAGG EMBUTIDA

230V LED 12W 3000K 406lm Ra80 IP65

R13620 branco

€ 120

R13621 preto

€ 120



↑ 80

⚡ 80x230



LED

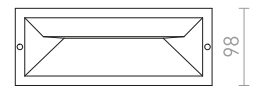
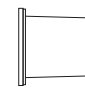

5 85

250 98





IP65



IP65



IP65

DEJAVU

Luminária embutida LED para montagem em parede para iluminação direcional de pavimentos, escadas ou terraços.

DEJAVU RC EMBUTIDA

230 V LED 4 W 3000 K 130 lm Ra 80 IP65

R12532 preto

€ 88

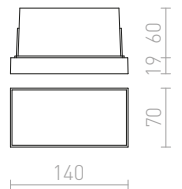
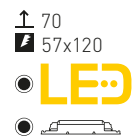

DEJAVU SQ 9 EMBUTIDA

230 V LED 3,5 W 3000 K 120 lm Ra 80 IP65

R12530 preto

€ 68

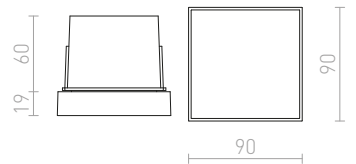
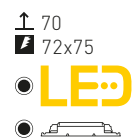

DEJAVU SQ 14 EMBUTIDA

230 V LED 6 W 3000 K 270 lm Ra 80 IP65

R12531 preto

€ 78

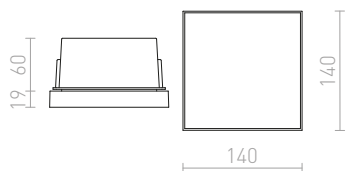
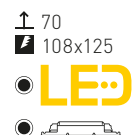



IP54



SEGNO

Aplique LED embutido para exterior com boa radiação emitida através de fenda estreita.

SEGNO EMBUTIDA

230 V LED 3 W 3000 K Ra 80 IP54

R13566 branco

€ 98

R13567 cinzento antracite

€ 98

↑ 70

↙ 172x62



LED

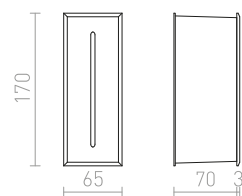

IP54



FACA

Luminária exterior montada na parede. O quadro visível tem uma profundidade de 2 cm. Iluminação descendente.

FACA EMBUTIDA

230 V LED 2 W 3000 K 130 lm Ra 80 IP54

R10557 cinzento prata

€ 58 %

↑ 100

↙ 225x85



LED

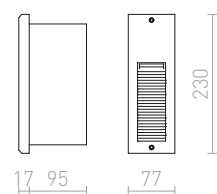



IP54

GAP

Luminária de parede embutida de alumínio lacado, adequada para uso em exteriores e interiores. Instale apenas para iluminação descendente.

GAP EMBUTIDA

230 V LED 3 W 3000 K 180 lm Ra 80 IP54

R10545 cinzento prata

€ 78 %

↑ 55
 190x45



LED

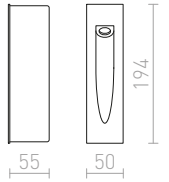

IP65

AKORD

Luz de parede para uso exterior com moldura de aço inoxidável e vidro transparente. Dimensões do vidro visível são 11,8/11,5 cm.

AKORD EMBUTIDO NA PAREDE

230 V LED 3 W 3000 K 260 lm Ra 80 IP65

R10546 aço inoxidável

€ 120 %

↑ 65
 180x155



LED

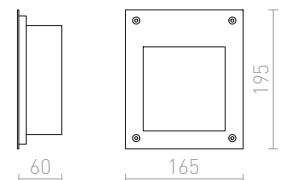





IP65



NAVY

Luminária LED maciça para instalação em tetos exteriores.

NAVY EMBUTIDA

230 V LED 15 W $\angle 36^\circ$ 2700 K 1100 lm Ra 80 IP65

R12661 branco

€ 120 %

↑ 110
 ⌀ 125

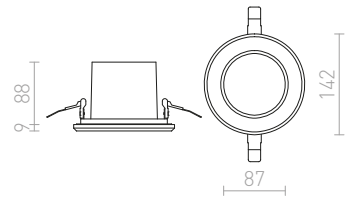
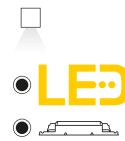

IP67



ORBU

Luminária de aço inoxidável de metal para exteriores.

ORBU R

230 V GU10 35 W IP67

R10555 aço inoxidável

€ 88

↑ 105
 ⌀ 98

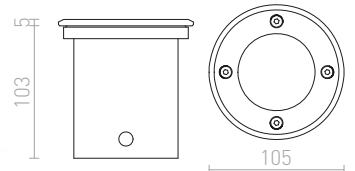

IP65



TERRA

Luminária de exterior embutida com LED de alta potência. Inclui um cabo de alimentação principal de 1m.

TERRA EMBUTIDA

230 V LED 20 W $\angle 120^\circ$ 3000 K 1450 lm Ra 80 IP65

R10532 aço inoxidável

€ 188

↑ 100
 ⌀ 190

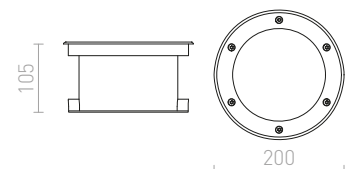
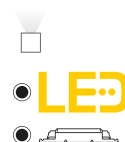



IP67



ORBU

Luminária de aço inoxidável de metal para exteriores.

ORBU SQ 10 EMBUTIDA

230 V LED GU10 15 W IP67

R13439 aço inoxidável

€ 88

↑ 140

● Ø100



G11837

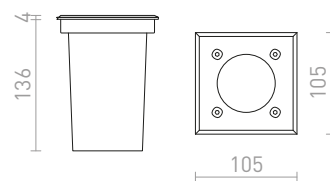

IP65



IP67



RIZZ

Luminária embutida de exterior para instalação no chão com LED integrado e driver.

RIZZ SQ 105

230 V LED 3 W ∠96° 3000 K 128 lm Ra 80 IP65

R10436 aço inoxidável

€ 150 →

↑ 120

● Ø90



LED

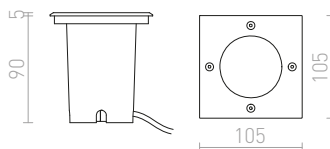

RIZZ SQ 125

230 V LED 7 W ∠41° 3000 K 433 lm Ra 80 IP67

R11962 aço inoxidável

€ 188 →

↑ 150

● Ø115



LED

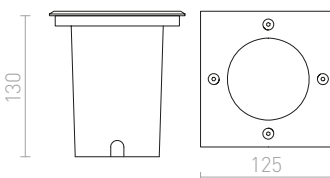







FONTES DE LUZ

GREEN

NEW!

NOVAS CATEGORIAS DE LÂMPADAS LED

MELHOR EFICIÊNCIA ENERGÉTICA
MAIOR QUALIDADE

Substitua facilmente as suas lâmpadas clássicas ou halogéneo atuais por E14, E27, GU10, G9, G53 e outros casquilhos.

MUITO BAIXO CONSUMO DE ENERGIA

VIDA ÚTIL EXTREMAMENTE LONGA

INSTANTANEAMENTE 100% LEVE, SEM ATRASO NO ACIONAMENTO

SEM UV E RADIAÇÃO INFRAVERMELHA MUITO BAIXA NO ESPECTRO VISÍVEL

EMISSÕES DE CALOR MUITO BAIXAS EM COMPARAÇÃO COM PRODUTOS DE REFERÊNCIA PADRÃO

DESIGN, PEQUENAS DIMENSÕES E SAÍDA DE LÚMEN COMPARÁVEIS ÀS LÂMPADAS INCANDESCENTES OU HALOGÉNEO



GLOSSÁRIO DE TERMOS

RETROFIT substituição direta da lâmpada clássica com encaixe E14 ou E27.

Não regulável / vida útil até 15,000 h / até 100,000 ciclos de comutação / Ra = 80

PRO lâmpada para uso profissional.

Regulável / vida útil até 45,000 h / até 1,000,000 de ciclos de comutação / Ra > 90

ADV alta qualidade e flexibilidade para todas as aplicações com escurecimento.

Regulável / vida útil até 40,000 h / até 100,000 ciclos de comutação / Ra = 80

GLOWdim escurece alterando a intensidade da luz, mas também a cor – de branco quente a branco muito quente (2700K-1800K).

Regulável / vida útil até 25,000 h / até 100,000 ciclos de comutação / Ra > 80

DIMM – pode ser atenuado com uma variedade de dimmer comercialmente disponíveis.

Bluetooth – Controlo por Bluetooth através de App.

WIFI – Controlo por WIFI através de App.

Ra (interpretação de cores) – mede a taxa de autenticidade de cores gerada por qualquer fonte de luz, em comparação com a luz do dia. Quanto mais perto o número é para 100, menor será a distorção de cor.



80 Ra

90 Ra

K (Kelvin) – descreve a temperatura de cor da luz.

1800 K 2700 K 3000 K 4000 K 6500 K 12000 K 16000 K



branco quente 1800–2700 K

branco neutro 3000–3500 K

branco frio 4000–4500 K

luz solar direta 5500–6500 K

Ângulos de feixe

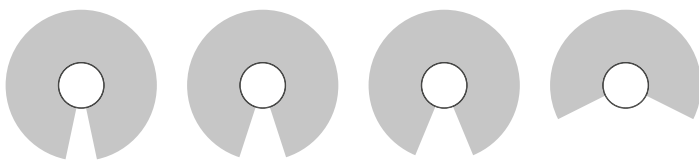

24°

36°

45°

120°



Todos os parâmetros técnicos se aplicam à lâmpada inteira. Devido ao complexo processo de produção de diodos emissores de luz, os valores típicos apresentados para os parâmetros técnicos de LED são valores puramente estatísticos que não necessariamente correspondem aos atuais parâmetros técnicos de cada produto, que podem variar do valor típico.

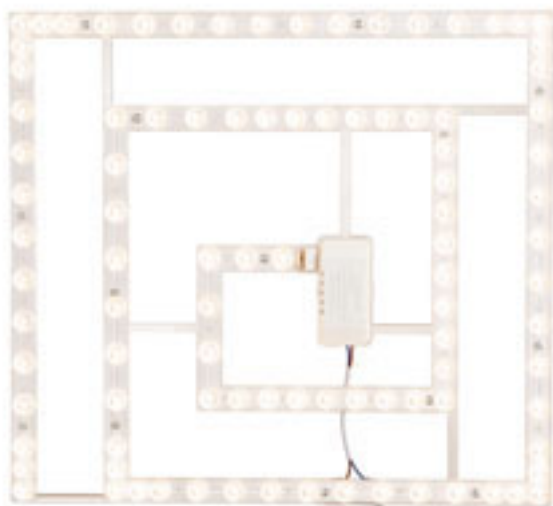

LED MODUL

Módulo LED de substituição para fácil uso em vez de fontes de luz existentes. O módulo LED é montado nas luminárias por meio de montagens magnéticas integradas.

LED MODUL SQ 10

230 V LED 12 W 3000 K 900 lm Ra 80

G13546

€ 6

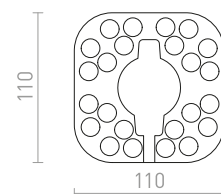
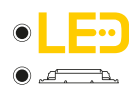

LED MODUL R 30

230 V LED 36 W 3000 K 2700 lm Ra 80

G13545

€ 15.50

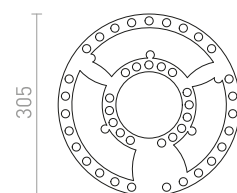

LED MODUL SQ 41

230 V LED 48 W 3000 K 3600 lm Ra 80

G13547

€ 22

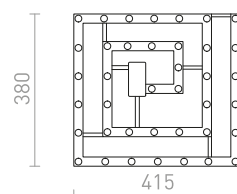



PARATHOM SMART

Fonte de luz LED inteligente com casquilho E27 controlável usando LEDVANCE SMART + Android 6.0 ou Apple Homekit. Gerenciamento de cores RGBW. Temperatura ajustável da cor da luz: 2700K a 6500K. Pode ser regulado por Bluetooth.

OSRAM SMART+ RGBW CLASSIC A

230 V E27 LED EQ 60 W 2700 K-6500 K 810 lm Ra 80

G13728 mate

€ 38

Ø60x120 mm

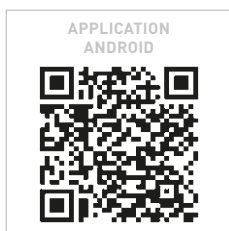

APPLICATION
ANDROID

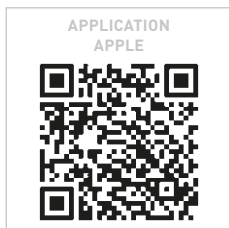

APPLICATION
APPLE



PARATHOM SMART

Fonte de luz LED inteligente com casquilho E27 controlável usando LEDVANCE SMART + Android 6.0 ou Apple Homekit. Pode ser regulado por Bluetooth.

OSRAM SMART+ CLASSIC

230 V E27 LED EQ 60 W 2700 K 800 lm Ra 80

G13700 mate

€ 35

Ø60x120 mm



PARATHOM RGBW

Fonte de luz LED onde a tecnologia RGB ou iluminação branca quente podem ser usadas. Fácil instalação sem uso de apps ou smartphone. Varie cores, cenas coloridas, ajuste a saturação de cores ou desvaneça com o toque de um botão. O pacote inclui um controle remoto infravermelho.

OSRAM RGBW CLASSIC A

230 V E27 LED EQ 60 W 2700 K 806 lm Ra 80

G13579 mate

€ 18.50

Ø60x114 mm





PARATHOM RGBW

Fonte de luz LED onde a tecnologia RGB ou iluminação branca quente podem ser usadas. Fácil instalação sem uso de apps ou smartphone. Varie cores, cenas coloridas, ajuste a saturação de cores ou desvaneça com o toque de um botão. O pacote inclui um controle remoto infravermelho.

OSRAM RGBW PAR16

230 V GU10 LED EQ 25 W 2700 K 250 lm Ra 80

G13577 branco

€ 14.50

Ø50x56 mm



PARATHOM RGBW

Fonte de luz LED onde a tecnologia RGB ou iluminação branca quente podem ser usadas. Fácil instalação sem uso de apps ou smartphone. Varie cores, cenas coloridas, ajuste a saturação de cores ou desvaneça com o toque de um botão. O pacote inclui um controle remoto infravermelho.

OSRAM RGBW LÂMPADA

230 V E14 LED EQ 40 W 2700 K 470 lm Ra 80

G13578 mate

€ 16

Ø47x91 mm

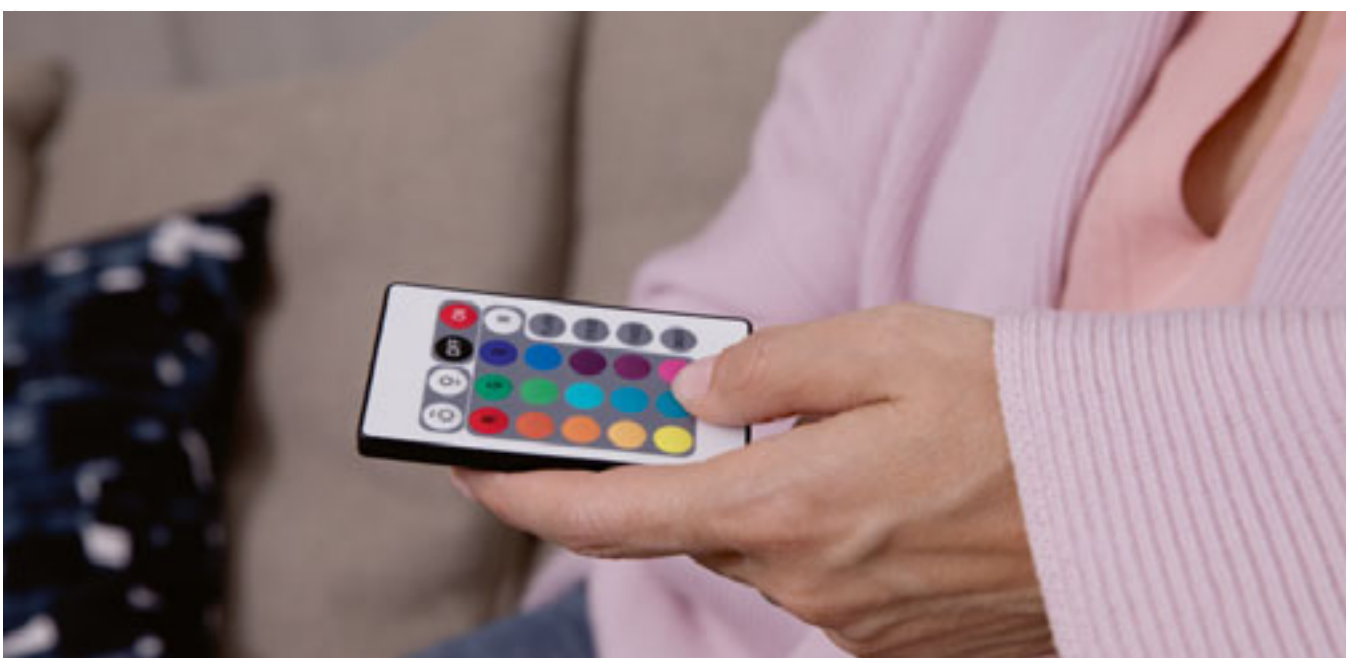



PARATHOM SMART

Fonte de luz LED Globe Smart WiFi com encaixe E27 regulável usando: LEDVANCE SMART+ WiFi (versão Android 4.4 ou iOS 9.0 ou superior), Google Assistant ou Amazon Alexa. Controlado por Wi-Fi.

OSRAM SMART+ GLOBE 125 WIFI

230 V E27 LED EQ 60 W 2700 K 806 lm Ra 80

G13943 claro

€ 32

NEW

Ø124x168 mm



OSRAM SMART+ GLOBE 125 WIFI

230 V E27 LED EQ 60 W 2700 K 806 lm Ra 80

G13944 âmbar

€ 28

NEW

Ø124x168 mm



OSRAM SMART+ GLOBE 125 WIFI

230 V E27 LED EQ 60 W 2700 K 806 lm Ra 80

G13945 de cor fumo

€ 28

NEW

Ø124x168 mm



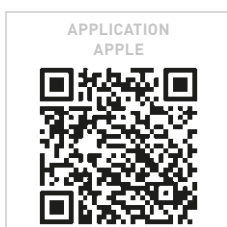

PARATHOM SMART

LED Lâmpada Globe Smart para casquilhos E27 que podem ser controlados a partir do aplicativo LEDVANCE SMART+ WiFi (é necessário Android 4.4 / iOS 9.0 ou superior), bem como Google Assistant ou Amazon Alexa. A funcionalidade RGBW permite selecionar cores ou definir uma temperatura de cor específica, de 2700K a 6500K. Usa WiFi para comunicar.

OSRAM SMART+ GLOBE 95

230 V E27 LED EQ 100 W RGBW 1521 lm Ra 80

G13833 mate

€ 38

NEW

Ø95x142 mm



**OSRAM
VINTAGE**



Ø75x156 mm
âmbar
230 V LED E27 EQ 40 W
2500 K 470 lm Ra 80
G13310

€ 25

**OSRAM
VINTAGE EDISON ESPIRAL**



Ø64x140 mm
de cor fumo
230 V LED E27 EQ 25 W
1800 K 250 lm Ra 80
G13581

€ 22

**OSRAM
VINTAGE EDISON SPIRAL**



Ø64x140 mm
âmbar
230 V LED E27 EQ 25 W
2000 K 250 lm Ra 80
G13309

€ 14

**OSRAM
RETROFIT EDISON**



Ø64x143 mm
claro
230 V LED E27 EQ 40 W
2700 K 470 lm Ra 80
G13573

€ 11

**OSRAM
VINTAGE GLOBE 125 DECO**



Ø125x168 mm
âmbar
230 V LED E27 EQ 40 W
2500 K 470 lm Ra 80
G13311

€ 25

**OSRAM
VINTAGE GLOBE 125 SPIRAL**



Ø125x178 mm
de cor fumo
230 V LED E27 EQ 15 W
1800 K 140 lm Ra 80
G13459

€ 22

**OSRAM
VINTAGE GLOBE 125 SPIRAL**



Ø125x178 mm
âmbar
230 V LED E27 EQ 25 W
2000 K 250 lm Ra 80
G13152

€ 15

**OSRAM
VINTAGE GLOBE 125 DIMM**



Ø125x173 mm
âmbar regulável
230 V LED E27 EQ 55 W
2400 K 650 lm Ra 80
G13023

€ 18.50

**OSRAM
VINTAGE VELA**



Ø35x100 mm
âmbar
230 V LED E14 EQ 35 W
2400 K 410 lm Ra 80
G13308

€ 8

**OSRAM
TOP CLASSIC A**



Ø60x105 mm
cromo
230 V LED E27 EQ 50 W
2700 K 650 lm Ra 80
G13154

€ 9.35

**OSRAM
TOP CLASSIC A**



Ø60x105 mm
folha dourada
230 V LED E27 EQ 50 W
2700 K 650 lm Ra 80
G13458

€ 9.35

**OSRAM
TOP MINI BOLA**



Ø45x78 mm
cromo
230 V LED E14 EQ 31 W
2700 K $\angle 320^\circ$ 380 lm Ra 80
G13013

€ 8.80

**OSRAM
VINTAGE TUB**



Ø28.5x138 mm
âmbar
230 V LED E27 EQ 20 W
2400 K 200 lm Ra 80
G13021

€ 12.50

**OSRAM
VINTAGE TUB**



Ø28.5x204 mm
âmbar
230 V LED E27 EQ 35 W
2400 K 400 lm Ra 80
G13022

€ 15.50

**OSRAM
RETROFIT GLOBE 125**



Ø124x168 mm
claro
230 V LED E27 EQ 25 W
2700 K 250 lm Ra 80
G12244 € 9.20

**OSRAM
RETROFIT GLOBE 125**



Ø124x168 mm
claro
230 V LED E27 EQ 40 W
2700 K 470 lm Ra 80
G12245 € 10.50

**OSRAM
RETROFIT GLOBE 125**



Ø124x168 mm
claro
230 V LED E27 EQ 60 W
2700 K 806 lm Ra 80
G12246 € 13

**OSRAM
RETROFIT GLOBE 125**



Ø124x168 mm
mate
230 V LED E27 EQ 100 W
2700 K 1521 lm Ra 80
G13460 € 22

**OSRAM
RETROFIT GLOBE 95**



Ø95x138 mm
mate
230 V LED E27 EQ 60 W
2700 K 806 lm Ra 80
G13024 € 8.80

**OSRAM
RETROFIT GLOBE 95 DIMM**



Ø95x138 mm
vidro colorido opala regulável
230 V LED E27 EQ 75 W
2700 K 1055 lm Ra 80
G13462 € 15.50

**OSRAM
RETROFIT GLOBE 95 DIMM**



Ø95x135 mm
vidro colorido opala regulável
230 V LED E27 EQ 100 W
2700 K 1521 lm Ra 80
G13461 € 19.50

**LAMBRINA
230**



Ø230x80 mm
mate
230 V LED E27 36 W
3000 K 2200 lm Ra 80
G13518 € 15.50

**OSRAM
RETROFIT TUBE**



Ø25x80 mm
claro
230 V LED E14 EQ 40 W
2700 K 470 lm Ra 80
G13150 € 8.80

**LED E27
TUBE**



Ø50x100 mm
230 V LED E27 7,5 W
3000 K $\angle 180^\circ$ 700 lm Ra 80
G12985 € 3.80

**OSRAM
TUBE**



Ø40.4x115 mm
mate
230 V LED E27 EQ 75 W
2700 K 1050 lm Ra 80
G13155 € 7.20

**OSRAM
RETROFIT VELA**



Ø35x100 mm
claro
230 V LED E14 EQ 40 W
2700 K 470 lm Ra 80
G11849

€ 5.20

**OSRAM
RETROFIT VELA**



Ø35x100 mm
claro
230 V LED E14 EQ 40 W
4000 K 470 lm Ra 80
G13455

€ 5.20

**OSRAM
RETROFIT VELA**



Ø35x100 mm
claro
230 V LED E14 EQ 60 W
2700 K 806 lm Ra 80
G13725

€ 7.20

**OSRAM
RETROFIT VELA DIMM**



Ø35x97 mm
mate regulável
230 V LED E14 EQ 40 W
2700 K 470 lm Ra 80
G13151

€ 7.50

**OSRAM
RETROFIT VELA DIMM**



Ø35x97 mm
mate regulável
230 V LED E14 EQ 60 W
2700 K 806 lm Ra 80
G13454

€ 11

**OSRAM
RETROFIT MINI BOLA DIMM**



Ø45x78 mm
mate regulável
230 V LED E14 EQ 25 W
2700 K 250 lm Ra 80
G13847 NEW

€ 7.80

**OSRAM
RETROFIT MINI BOLBO DE
LUZ**



Ø45x78 mm
claro
230 V LED E14 EQ 40 W
2700 K 470 lm Ra 80
G12243

€ 5.50

**OSRAM
RETROFIT MINI BOLA DIMM**



Ø45x78 mm
claro regulável
230 V LED E14 EQ 60 W
2700 K 806 lm Ra 80
G13572

€ 9.50

**OSRAM
RETROFIT MINI BOLA**



Ø45x77 mm
mate
230 V LED E14 EQ 40 W
2700 K 470 lm Ra 80
G13098

€ 5.35

**OSRAM
RETROFIT MINI BOLA DIMM**



Ø45x78 mm
mate regulável
230 V LED E14 EQ 60 W
2700 K 806 lm Ra 80
G13453

€ 11

**OSRAM
RETROFIT MINI BOLBO DE
LUZ DIMM**



Ø45x77 mm
claro regulável
230 V LED E27 EQ 40 W
2700 K 470 lm Ra 80
G13014

€ 8

**OSRAM
RETROFIT MINI BOLA**



Ø45x77 mm
claro
230 V LED E27 EQ 60 W
2700 K 806 lm Ra 80
G13307

€ 7.50

**OSRAM
RETROFIT MINI BOLA DIMM**



Ø45x77 mm
mate regulável
230 V LED E27 EQ 25 W
2700 K 250 lm Ra 80
G13119

€ 7.80

**OSRAM
RETROFIT MINI BOLA DIMM**



Ø45x77 mm
mate regulável
230 V LED E27 EQ 40 W
2700 K 470 lm Ra 80
G13015

€ 8.25

**OSRAM
RETROFIT CLASSIC A DIMM**



Ø60x105 mm
claro regulável
230 V LED E27 EQ 40 W
2700 K 470 lm Ra 80
G13110 € 7.20

**OSRAM
RETROFIT CLASSIC A DIMM**



Ø60x105 mm
claro regulável
230 V LED E27 EQ 60 W
2700 K 806 lm Ra 80
G13111 € 7.20

**OSRAM
RETROFIT CLASSIC A DIMM**



Ø60x105 mm
claro regulável
230 V LED E27 EQ 75 W
2700 K 1055 lm Ra 80
G13112 € 11

**OSRAM
RETROFIT CLASSIC A DIMM**



Ø60x105 mm
claro regulável
230 V LED E27 EQ 100 W
2700 K 1521 lm Ra 80
G13123 € 12

**OSRAM
RETROFIT CLASSIC A DIMM**



Ø60x105 mm
mate regulável
230 V LED E27 EQ 40 W
2700 K 470 lm Ra 80
G13099 € 8.25

**OSRAM
RETROFIT CLASSIC A DIMM**



Ø60x105 mm
mate regulável
230 V LED E27 EQ 60 W
2700 K 806 lm Ra 80
G13026 € 8.25

**OSRAM
RETROFIT CLASSIC A DIMM**



Ø60x105 mm
mate regulável
230 V LED E27 EQ 60 W
4000 K 806 lm Ra 80
G13027 € 8.25

**OSRAM
RETROFIT CLASSIC A DIMM**



Ø60x105 mm
mate regulável
230 V LED E27 EQ 75 W
2700 K 1055 lm Ra 80
G13028 € 10.50

**OSRAM
RETROFIT CLASSIC A DIMM**



Ø60x105 mm
mate regulável
230 V LED E27 EQ 75 W
4000 K 1055 lm Ra 80
G13477 € 11.50

**OSRAM
RETROFIT CLASSIC A**



Ø60x105 mm
mate
230 V LED E27 EQ 100 W
2700 K 1521 lm Ra 80
G13029 € 11.50

**OSRAM
RETROFIT CLASSIC A DIMM**



Ø60x105 mm
mate regulável
230 V LED E27 EQ 100 W
2700 K 1521 lm Ra 80
G13306 € 13

**OSRAM
RETROFIT CLASSIC A**



Ø70x118 mm
mate
230 V LED E27 EQ 150 W
2700 K 2452 lm Ra 80
G13457 € 22

**OSRAM
ADV CLASSIC A DIMM**



Ø67x143 mm
mate regulável
230 V LED E27 EQ 150 W
2700 K <200° 2452 lm Ra 80
G12237 € 22

**OSRAM
RETROFIT CLASSIC A**



Ø95x162 mm
mate
230 V LED E27 EQ 200 W
2700 K 3452 lm Ra 80
G13831 NEW € 28

**OSRAM
RETROFIT CLASSIC A DIMM**



Ø90x184 mm
mate regulável
230 V LED E27 EQ 200 W
2700 K 3452 lm Ra 80
G13832 NEW € 32

**OSRAM
PIN MICRO G4**



Ø10x30 mm
12 V LED G4 EQ 10 W
2700 K ∠300° 100 lm Ra 80
G13828 NEW € 10.50

**OSRAM
PIN G4**



Ø13x36 mm
12 V LED G4 EQ 20 W
2700 K ∠300° 200 lm Ra 80
G13034 € 7.20

**OSRAM
PIN G4**



Ø14x40 mm
12 V LED G4 EQ 30 W
2700 K ∠320° 300 lm Ra 80
G13035 € 8.50

**OSRAM
PIN G9**



Ø16x60 mm
vidro transparente
230 V LED G9 EQ 30 W
2700 K ∠320° 300 lm Ra 80
G13478 € 11

**OSRAM
PIN G9**



Ø15x46 mm
230 V LED G9 EQ 20 W
2700 K 200 lm Ra 80
G13715 € 6.80

**OSRAM
PIN G9**



Ø15x52 mm
230 V LED G9 EQ 30 W
2700 K ∠300° 320 lm Ra 80
G13036 € 8.25

**OSRAM
PIN G9 DIMM**



Ø18x59 mm
regulável
230 V LED G9 EQ 40 W
2700 K 470 lm Ra 80
G13830 NEW € 22

**OSRAM
PIN G9**



Ø20x58 mm
230 V LED G9 EQ 40 W
2700 K ∠300° 470 lm Ra 80
G13037 € 12

**OSRAM
PIN G9**



Ø19x52 mm
230 V LED G9 EQ 40 W
4000 K ∠300° 470 lm Ra 80
G13038 € 12

**OSRAM
PIN G9**



Ø18x59 mm
230 V LED G9 EQ 50 W
2700 K ∠320° 600 lm Ra 80
G13464 € 16.50

**OSRAM
HALO PIN G9**



Ø14x43 mm
claro regulável
230 V G9 EQ 25 W
2700 K 235 lm Ra 100
G13122 € 4.80

**OSRAM
HALO PIN G9**



Ø14x43 mm
claro regulável
230 V G9 EQ 40 W
2700 K 460 lm Ra 100
G13045 € 4.80

**OSRAM
SPECIAL SLIM**



Ø18x90 mm
claro
230 V LED B15d EQ 60 W
2700 K ∠320° 806 lm Ra 80
G13456 € 38

**OSRAM
SPECIAL SLIM DIMM**



Ø18x100 mm
claro regulável
230 V LED B15D EQ 75 W
2700 K 1055 lm Ra 80
G13574 € 48

**OSRAM
SLIM LINE 118MM**



Ø20x118 mm
claro
230 V LED R7S EQ 100 W
2700 K 1521 lm Ra 80
G13576 € 24

**OSRAM
LINE 118MM DIMM**



Ø28x118 mm
regulável
230 V LED R7S EQ 125 W
2700 K ∠300° 2000 lm Ra 80
G13044 € 35

**OSRAM
LINE 118MM DIMM**



Ø28x118 mm
claro regulável
230 V LED R7s EQ 150 W
2700 K 2452 lm Ra 80
G13468 € 58

**OSRAM
SLIM LINE 78MM**



Ø20x78 mm
claro
230 V LED R7S EQ 60 W
2700 K ∠300° 806 lm Ra 80
G13575 € 16

**OSRAM
LINE 78MM DIMM**

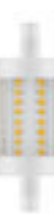

Ø29x78 mm
regulável
230 V LED R7S EQ 75 W
2700 K ∠300° 1055 lm Ra 80
G13043 € 17.50

**OSRAM
LINE 78MM DIMM**

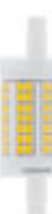

Ø28x78 mm
claro regulável
230 V LED R7s EQ 100 W
2700 K 1521 lm Ra 80
G13467 € 29

**OSRAM
HALO LINE 78MM**



Ø12x78 mm
claro regulável
230 V R7S EQ 60 W
2900 K 750 lm Ra 100
G13047 € 8.80

**OSRAM
ADV MR16 DIMM**



Ø51x46 mm
regulável
12 V LED GU5,3 EQ 35 W
3000 K ∠36° 350 lm Ra 90

G12233 € 12

**OSRAM
PRO MR16 DIMM**



Ø51x46 mm
regulável
12 V LED GU5,3 EQ 20 W
3000 K ∠36° 230 lm Ra 97

G12234 € 18.50

**OSRAM
MR16 DIMM**



Ø50x46 mm
regulável
12 V LED GU5,3 EQ 50 W
3000 K ∠36° 561 lm Ra 90

G13705 € 17.50

**OSRAM
PAR16 DIMM**



Ø51x55 mm
regulável
230 V LED GU10 EQ 35 W
2700 K ∠36° 230 lm Ra 90

G13120 € 7.50

**OSRAM
ADV PAR16 DIMM**



Ø51x55 mm
regulável
230 V LED GU10 EQ 35 W
3000 K ∠36° 230 lm Ra 90

G11837 € 7.50

**OSRAM
ADV PAR16 DIMM**



Ø51x55 mm
regulável
230 V LED GU10 EQ 35 W
4000 K ∠36° 230 lm Ra 90

G12206 € 7.50

**OSRAM
PRO PAR16 DIMM**



Ø51x55 mm
regulável
230 V LED GU10 EQ 35 W
3000 K ∠36° 230 lm Ra 97

G11852 € 10.50

**OSRAM
ADV PAR16 DIMM**



Ø51x55 mm
regulável
230 V LED GU10 EQ 50 W
2700 K ∠36° 350 lm Ra 90

G11840 € 8.25

**OSRAM
ADV PAR16 DIMM**



Ø51x55 mm
regulável
230 V LED GU10 EQ 50 W
3000 K ∠36° 350 lm Ra 90

G11841 € 8.25

**OSRAM
ADV PAR16 DIMM**



Ø51x55 mm
regulável
230 V LED GU10 EQ 50 W
4000 K ∠36° 350 lm Ra 90

G12207 € 8.25

**OSRAM
PAR16**



Ø51x55 mm
regulável
230 V LED GU10 EQ 50 W
2700 K ∠120° 350 lm Ra 80

G12232 € 5.80

**OSRAM
ADV PAR16 DIMM**



Ø50x52 mm
regulável
230 V LED GU10 EQ 80 W
3000 K ∠36° 550 lm Ra 90

G12065 € 13

**OSRAM
PAR16 DIMM**



Ø51x54 mm
regulável
230 V LED GU10 EQ 80 W
4000 K ∠36° 575 lm Ra 90

G13041 € 13

**OSRAM
PAR16 DIMM**



Ø50x52 mm
regulável
230 V LED GU10 EQ 80 W
2700 K ∠120° 575 lm Ra 90

G13040 € 13

**OSRAM
PAR16 DIMM**



Ø50x52 mm
regulável
230 V LED GU10 EQ 100 W
3000 K ∠36° 750 lm Ra 80

G13706 € 18.50

**OSRAM
PAR16**



Ø50x53 mm
branco
230 V LED GU10 EQ 35 W
2700 K ∠36° 230 lm Ra 80
G13465 € 4.20

**OSRAM
PAR16**



Ø50x53 mm
branco
230 V LED GU10 EQ 50 W
2700 K ∠36° 350 lm Ra 80
G13466 € 5.80

**ALFA
69**



Ø69x70 mm
cinzento prata/cromo
230 V LED GU10 6 W
3000 K ∠24° 300 lm Ra 80
G13406 € 12

**ALFA
69**



Ø69x70 mm
cinzento prata/cromo
230 V LED GU10 6 W
4000 K ∠24° 300 lm Ra 80
G13407 € 12

**OSRAM
PRO AR111 DIMM**



Ø111x62 mm
regulável
12 V LED G53 EQ 50 W
3000 K ∠24° 450 lm Ra 90
G13722 € 38

**OSRAM
PRO AR111 DIMM**



Ø111x62 mm
regulável
12 V LED G53 EQ 100 W
2700 K ∠24° 950 lm Ra 90
G13723 € 48

**OSRAM
PRO AR111 DIMM**



Ø111x62 mm
regulável
12 V LED G53 EQ 75 W
4000 K ∠24° 820 lm Ra 90
G13724 € 48

**OSRAM
PRO AR111 DIMM**



Ø111x62 mm
regulável
12 V LED G53 EQ 50 W
3000 K ∠40° 450 lm Ra 97
G13655 € 38

**OSRAM
PRO AR111 DIMM**



Ø111x62 mm
regulável
12 V LED G53 EQ 75 W
3000 K ∠40° 800 lm Ra 97
G13656 € 48

**OSRAM
PRO AR111 DIMM**



Ø111x62 mm
regulável
12 V LED G53 EQ 75 W
3000 K ∠24° 800 lm Ra 97
G13657 € 48

**LED
ES111**



Ø111x70 mm
branco
230 V LED GU10 12 W
3000 K ∠45° 1000 lm Ra 80
G12723 € 11.50

**LED
ES111**



Ø111x70 mm
cinzento
230 V LED GU10 12 W
3000 K ∠45° 1000 lm Ra 80
G12724 € 11.50

**LED
ES111**



Ø111x70 mm
branco
230 V LED GU10 12 W
4000 K ∠45° 1000 lm Ra 80
G12725 € 11.50

**LED
ES111**



Ø111x70 mm
cinzento
230 V LED GU10 12 W
4000 K ∠45° 1000 lm Ra 80
G12726 € 11.50

**OSRAM
R50 DIMM**



Ø50x85 mm
regulável
230 V LED E14 EQ 60 W
2700 K ∠36° 345 lm Ra 90

G13147 € 11.50

**OSRAM
R63 DIMM**



Ø63x105 mm
regulável
230 V LED E27 EQ 60 W
2700 K ∠36° 345 lm Ra 90

G13148 € 13.50

**OSRAM
R80 DIMM**



Ø80x115 mm
regulável
230 V LED E27 EQ 100 W
2700 K ∠36° 670 lm Ra 80

G13149 € 17.50

**OSRAM
PAR20 DIMM**



Ø65x85 mm
regulável
230 V LED E27 EQ 50 W
2700 K ∠36° 345 lm Ra 90

G13020 € 12

**OSRAM
ADV PAR30 DIMM**



Ø95x90 mm
regulável
230 V LED E27 EQ 75 W
2700 K ∠36° 633 lm Ra 90

G12067 € 22

**OSRAM
ADV PAR38 DIMM**



Ø120x132 mm
regulável
230 V LED E27 EQ 120 W
2700 K ∠30° 1035 lm Ra 80

G12068 € 32



**OSRAM
PAR16 GLOWDIM**



Ø50x54 mm
regulável
230 LED GU10 EQ 50 W
2700 K ∠36° 350 lm Ra 80

G13185 € 11

**OSRAM
ADV VELA GLOWDIM**



Ø38x105 mm
mate regulável
230 V LED E14 EQ 40 W
2700 K 470 lm Ra 80

G12209 % € 9.35

**OSRAM LEDINESTRA
1P 30 DIMM**



Ø300 mm
mate regulável
230 V LED S14d EQ 27 W
2700 K 275 lm Ra 80

G11860 € 35

**OSRAM LEDINESTRA
1P 50 DIMM**



Ø500 mm
mate regulável
230 V LED S14d EQ 40 W
2700 K 470 lm Ra 80

G11862 € 48

**OSRAM LEDINESTRA
2P 30 DIMM**



Ø300 mm
mate regulável
230 V LED S14s EQ 27 W
2700 K 275 lm Ra 80

G11859 € 35

**OSRAM LEDINESTRA
2P 50 DIMM**



Ø500 mm
mate regulável
230 V LED S14s EQ 40 W
2700 K 470 lm Ra 80

G11861 € 48

**OSRAM LEDINESTRA
2P 100 DIMM**



Ø29x1000 mm
mate regulável
230 V LED S14s EQ 75 W
2700 K 1055 lm Ra 80

G12251 € 88

**OSRAM
DULUX L**



Ø413 mm
mate
230 V LED 2G11 EQ 36 W
3000 K 2070 lm Ra 80

G13469 € 48

**OSRAM
DULUX L**



Ø413 mm
mate
230 V LED 2G11 EQ 36 W
4000 K 2300 lm Ra 80

G13470 € 48

**OSRAM
STAR**



Ø75x28 mm
230 V LED GX53 EQ 40 W
2700 K ∠120° 470 lm Ra 80

G13032 € 11

**OSRAM
STAR**



Ø75x28 mm
230 V LED GX53 EQ 40 W
4000 K ∠120° 470 lm Ra 80

G13033 € 11

**PUC
FONTE DE LUZ**



Ø74x27 mm
230 V LED GX53 7 W
3000 K ∠105° 560 lm Ra 80

G12340 € 8



ACESSÓRIOS PARA
CANDEEIROS



DRIVER

LED driver 350mA.

DRIVER LED 1-3W

350 mA 4,2W

G13124

€ 5.20

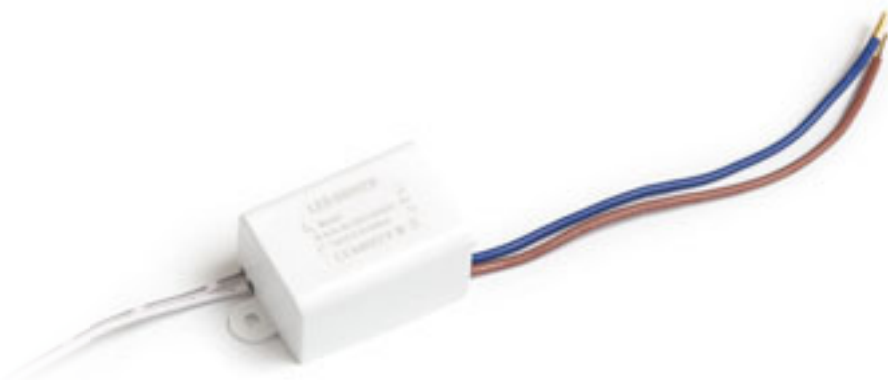
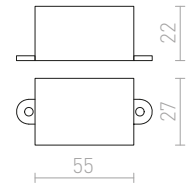

DRIVER

Driver LED 700mA.

DRIVER LED 1x3W

700 mA 3 W

G13125

€ 3.20

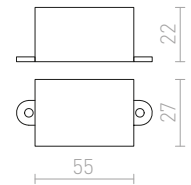

DRIVER

LED driver 350mA.

DRIVER LED 3-8W

350 mA 8,5 W

G13008

€ 26

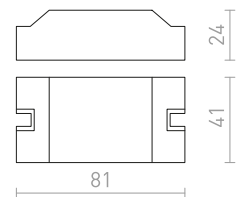

DRIVER

LED driver 350mA.

DRIVER LED 7-15W

350 mA 16 W

G13806

€ 9 **NEW**

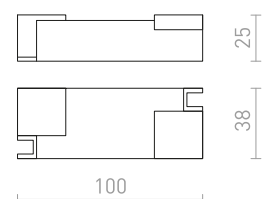



TRAFÓ 12V

Transformador 12 AC.

TRAFÓ 20-70W 12V AC DIMM

12 V 70 W

G13002

€ 17

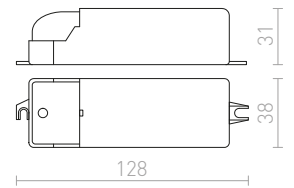

TRAFÓ 12V

Transformador 12 AC.

TRAFÓ 35-105W 12V AC DIMM

12 V 105 W

G13003

€ 18.50

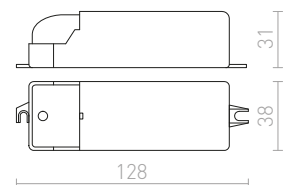

TRAFÓ 12V

Transformador 12 AC.

TRAFÓ 50-150W 12V AC DIMM

12 V 150 W

G13004

€ 58

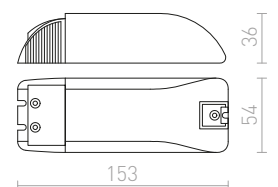



DRIVER

Controlador LED 500mA 9-18W. TRIAC regulável.

DRIVER LED 9-18W DIMM

500 mA max. 18 W

G13840

€ 35 **NEW**

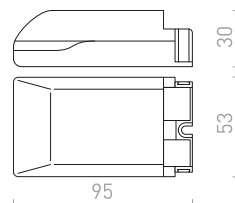

regulável



DRIVER

Driver LED 700mA 3x3W. Regulador TRIAC.

DRIVER LED 3x3W DIMM

700 mA 10 W

G13009

€ 35

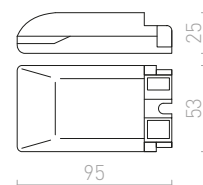

regulável



TRAFO 24V=

Transformador 24V DC.

TRAFO 0,5-20W

24= 20 W

G13006

€ 48

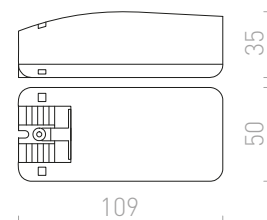



IP44

IP-BOX

Bloco de terminais com proteção contra ambientes húmidos. Adequado para cabo 3x1,5.

IP-BOX

IP44

G12582 branco

€ 1.80

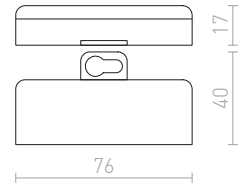

IP67

IP-BOX

Junta de ligação adequada para ambientes externos. Adequado para cabo 3x1,5.

IP-BOX

230 V IP67

G12984

€ 5

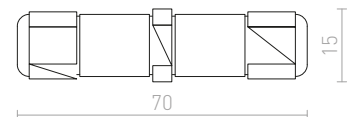

IP65

IP-BOX

Caixas de ligação adequadas para ambientes externos. Adequado para cabo 3x1,5.

IP-BOX

230 V IP65

G12983

€ 3.80

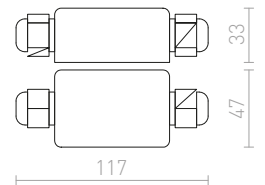

IP68

IP-BOX

Junta de cabo para uso externo. Adequado para cabos 2x1,5. Fornecido com 4 arruelas e 2 fichas.

IP-BOX IP68

IP68

G13846 preto

€ 11.50

NEW

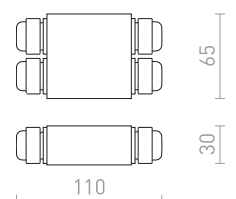



SENSOR

Adaptador no casquilho E27 com sensor de movimento integrado.

SENSOR E27

230 V E27 60 W ∠360°

G12752

€ 11 %

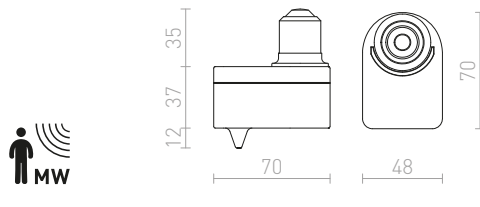

SENSOR

Sensor de movimento para montagem no teto ou na parede.

SENSOR TETO

230 V max 2000 W ∠360°

G12754

€ 13.50

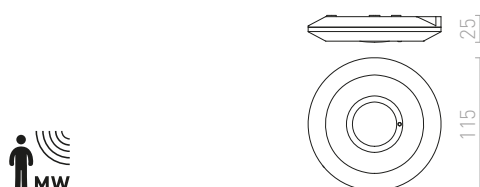

SENSOR

Sensor de movimento para montagem em luminárias adequadas.

SENSOR PARA ENCAIXE NUMA LUMINÁRIA

230 V max 1200 W ∠360°

G12755 branco

€ 11

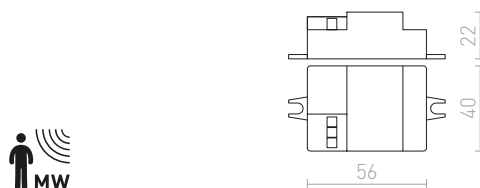

IP-BOX

Cobertura durável em ambiente húmido para proteger o sensor de movimento G12755.

IP-BOX PARA SENSOR G12755

IP65

G12756

€ 4.50 %

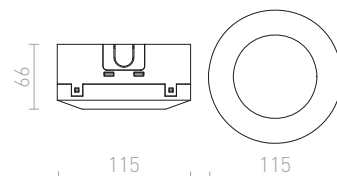

IP65





SENSOR

Sensor de movimento com sensor externo no cabo. O sensor externo é usado apenas para detectar (determinar) a intensidade da luz para o correto funcionamento do sensor.

SENSOR ACIMA DO TETO

max 1200 W ∠360°

G12753 branco

€ 14.50

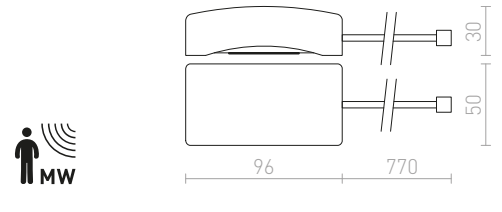

IP65

SENSOR

Sensor de movimento para montagem em luminárias.

SENSOR PARA MONTAGEM EM LÂMPADAS EXTERIORES

230 V max 500 W ∠180° IP65

G12757 branco

€ 6.80

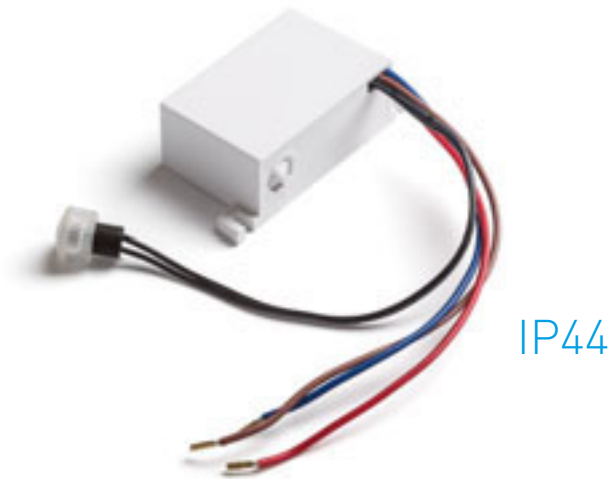
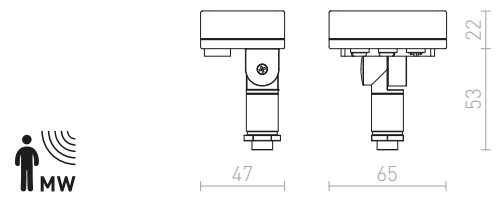

IP44

DARK SENSOR

Interruptor Twilight para troca automática com sensor externo.

DARK SENSOR 5-50 LUX INCORPORADO

230 V IP44

G12758 branco

€ 5.50

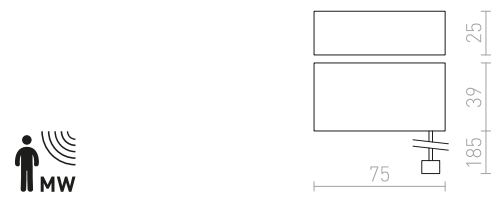

IP44

DARK SENSOR

Interruptor Twilight para comutação automática em design ao ar livre.

DARK SENSOR 2-100 LUX DE SUPERFÍCIE

230 V IP44

G12759 preto

€ 8.25

G13528 branco

€ 7.80

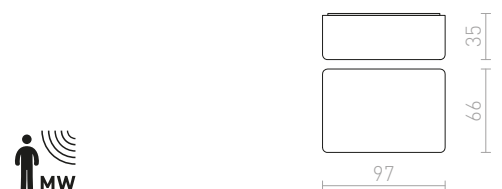

1

1F calha 532-533

A

ABAX de pé 636-637
ACASA embutida 448-449
ACUA embutida 404-405
ADAGIO na parede 210-211
AGATE na parede 268-269
AGATE teto 146-147
AGNETA montado à superfície 330-331
AGNETA suspenso 14-15
AIM com braço articulado 320-321
AINO suspenso 24-25
AKORD embutido na parede 720-721
ALFA 740-741
ALGOT de mesa 342-343
ALLEGRO DIMM teto 170-171
ALVIS base candeeiro de pé 610-611
ALVIS base candeeiro de mesa 610-611
ALVIS Abajur candeeiro de mesa 574-575
AMADEUS na parede 316-317
AMARO 478-479
AMBER na parede 272-273
AMBITUS abajur candeeiro de pé 574-575
AMBITUS base candeeiro de pé 610-611
AMBITUS base candeeiro de mesa 610-611
AMBITUS abajur de mesa 574-575
AMENITY na parede 208-209
AMERICANO de mesa 342-343
AMICI suspenso de silicone 28-29
AMIGA DIMM 398-399
ANDANTE na parede 666-667
ANIKA de mesa 352-353
ANTE na parede 238-239
APRIORI 402-403
AQILA na parede 272-273
AQUE na parede 270-271
AQUE vertical 636-637
ARANA de superfície 158-159
ARANA teto 112-113
ARAQ na parede 314-315
ARAQ suspenso 14-15
ASHLEY na parede 236-237
ASPEN de superfície 664-665
ASPRO abajur 570-571
ASTERI suspenso 58-59
ASTERIA embutida 474-475
ASTON para calha trifásica 518-519
ASTON suspenso 70-71
ASTOR 406-407
ASTRAL suspenso 16-17
ASTROMET suspenso 16-17
ATHI na parede 252-253
ATIKA teto 130-131
ATLANTA de superfície 252-253
AWE teto 108-109
AZRIA suspenso 40-41

B

BABADES para calha monofásica 548-549
BABADES para calha trifásica 520-521
BABADES suspenso 76-77
BABU suspenso 48-49
BABYMOON suspenso ou de pé 628-629
BAHIA para calha trifásica 508-509
BALEA para armários 204-205
BAROQUE na parede 330-331

BARRY teto 108-109
BEACON na parede 628-629
BEAT abajur suspenso 568-569
BEAU MONDE suspenso 18-19
BEEBA para calha monofásica 544-545
BEEBA para calha trifásica 514-515
BEJA na parede 682-683
BELENOS para calha monofásica 540-541
BELENOS suspensa para calha monofásica 548-549
BELENOS para calha trifásica 512-513
BELENOS suspensa para calha trifásica 520-521
BELENOS teto 132-133
BELENOS suspenso 80-81
BELL embutida 400-401
BELLA embutida 396-397
BELLINI para calha trifásica 522-523
BELLINI suspenso 40-41
BEND base arqueada na parede 606-607
BENITA na parede 240-241
BERIT 148-149
BERLINO suspenso 90-91
BERMUDA embutida 402-403
BIANCA embutida 426-427
BIARITZ na parede 256-257
BISOU suspenso 18-19
BJORK embutida 450-451
BLONDIE para calha monofásica 550-551
BLONDIE para calha trifásica 518-519
BLONDIE suspenso 70-71
BLUESTAR com espigão 696-697
BOB com braço articulado 322-323
BOBO na parede 274-275
BOBO de pé 640-641
BODIE na parede 240-241
BOGARD extensor para suspensos 80-81
BOGARD na parede 296-297
BOGARD teto 132-133
BOGARD suspenso 80-81
BOLLY de superfície 222-223
BOLLY teto 114-115
BOLLY suspenso 44-45
BONDY embutida 436-437
BONNIE na parede 632-633
BONNIE vertical 632-633
BONO superfície 124-125
BORA com espigão 698-699
BORA na parede 694-695
BOSANNA de pé 630-631
BOSANOVA de pé 630-631
BOULOGNE de pé 366-367
BOURDON na parede 680-681
BRAN embutida 408-409
BROADWAY de mesa 348-349
BROADWAY suspenso ajustável 60-61
BROADWAY com braço suspenso 62-63
BRUXEL na parede 252-253
BUCKY para calha trifásica 518-519
BUCKY suspenso 30-31
BUGSY na parede 332-333
BUGSY de pé 374-375
BUGSY de mesa 354-355
BURTON para calha trifásica 528-529
BURTON suspenso 38-39

C

CABOX na parede 672-673
CADENZA para calha monofásica 540-541

CADENZA para calha trifásica 510-511
CAMARGUE na parede 658-659
CAMINO de mesa 340-341
CAMINO de mesa com abajur 340-341
CAMINO suspenso 38-39
CANTO anel decorativo 138-139
CANTO Foco sem abajur interno 138-139
CARISSIMA suspenso 76-77
CARRE na parede 254-255
CASSABLANCA suspenso 58-59
CASSAMBA na parede 214-215
CASSIE na parede 332-333
CASUAL abajur 588-589
CELEIA montado à superfície 330-331
CELEIA de mesa 352-353
CHIC na parede 240-241
CHICAGO na parede 664-665
CHLOE na parede 264-265
CHOIX na parede 690-691
CHOUPETTE de parede ajustável 314-315
CHOUPETTE para calha monofásica 548-549
CHOUPETTE para calha trifásica 522-523
CHOUPETTE suspenso 32-33
CINDY suspenso 66-67
CIRA teto 106-107
CLAIRE na parede 656-657
CLANK suspenso 22-23
CLUB embutida 474-475
CLYDE na parede 632-633
CLYDE vertical 632-633
COCO suspenso 20-21
COIMBRA embutida 410-411
COLES luz de teto 130-131
COLES direcional de teto 130-131
COLIN teto 126-127
COMODO na parede 670-671
CONDU teto 134-135
CONFETTI suspenso 20-21
CONNOR para calha monofásica 542-543
CONNOR para calha trifásica 510-511
CONNOR teto 136-137
CONNOR abajur 572-573
CONNOR abajures de mesa 572-573
CONNOR abajur 572-573
COPA para calha monofásica 550-551
COPA para calha trifásica 524-525
COPA suspenso 14-15
CORAZON 220-221
CORDOBA com espigão 696-697
COROA suspenso 42-43
CORONA suspenso 40-41
CORTINA base candeeiro de pé 614-615
CORTINA abajur de mesa 614-615
COSMO com espigão 698-699
COWLEY na parede 242-243
COZY de mesa 356-357
CRESCENDO na parede 216-217
CRESCENT na parede 244-245
CUBO em superfície 146-147

D

DADA embutida 452-453
DADOS suspenso 56-57
DAFFY na parede 256-257
DAG embutida 414-415
DAISY abajur suspenso 568-569
DAN embutida 418-419
DANDY embutida 414-415

DANTE de pé	364-365	ESPLANADE de pé	366-367	GORDIQ embutida	482-483
DARIO anel decorativo	134-135	ESPLANADE de mesa	350-351	GORRA teto	108-109
DARIO para calha monofásica	542-543	ESPLANADE suspenso	32-33	GRANADA	432-433
DARIO para calha trifásica	510-511	ESSEX na parede	262-263	GRANDE teto	104-105
DARIO teto	134-135	ESTRA suspenso	54-55	GRANITA na parede	240-241
DARK SENSOR de superfície	750-751	ETESIAN de pé	370-371	GUN com espigão	696-697
DARK SENSOR incorporado	750-751	EUTRAC calha trifásica	494-495		
DEJAVU embutida	484-485	EX teto quadrado	150-151		
DELI abajur	578-579	EZRA suspenso	22-23		
DELISA abajur	578-579				
DELTA na parede	664-665	F			
DELTA de superfície	662-663	FABIO conjunto suspenso	600-601	H	
DESMOND na parede	268-269	FACA embutida	720-721	HAREN de superfície	314-315
DESTY para calha monofásica	550-551	FADO na parede	318-319	HAY na parede	250-251
DESTY para calha trifásica	520-521	FADO de pé	374-375	HEAVY DUTY refletor exterior	700-701
DESTY suspenso	14-15	FADO de mesa	356-357	HEIDI de mesa	340-341
DEZA quadrado	122-123	FANCY suspenso	26-27	HEIDI suspenso	36-37
DIDO na parede	262-263	FANGIO para calha trifásica	508-509	HEX conjunto suspenso	596-597
DIFFUSER	586-587	FAO na parede	220-221	HIDE na parede	666-667
DIFFUSER PRISM	580-581	FAROS exterior	702-703	HUDSON na parede	234-235
DIGA	302-303	FAX para calha trifásica	516-517	HUE DIMM de teto	168-169
DINGO direcional	422-423	FIATLUX suspenso	26-27	HUE DIMM embutida	456-457
DINGO fixo	420-421	FIT cabo PPM	616-617	HUE teto	166-167
DINGO embutida	424-425	FIT cabo têxtil PPM	616-617	HUE embutida	454-455
DINO direcional	424-425	FIT cabo têxtil	616-617		
DIREZZA com espigão	696-697	FIZZ direcional	438-439	I	
DIREZZA na parede	692-693	FLAP na parede	324-325	IBIS de mesa	358-359
DIXIE na parede	686-687	FLATLINE para calha trifásica	500-501	ICAR para calha monofásica	548-549
DORA suspenso	42-43	FLORIDA suspenso	36-37	ICAR de pé	372-373
DOUBLE abajur	584-585	FLORINA de mesa	344-345	ICAR suspenso	32-33
DRIVER	746-747	FLORIO parede	218-219	ILLUSION abajur	576-577
DRIVER DIMM	748-749	FOCUS DIMM para calha monofásica	536-537	ILUSIA suspenso	38-39
DUBLIN de superfície	224-225	FOCUS DIMM para calha trifásica	502-503	IMPERIA na parede	210-211
DUDE na parede	300-301	FOND na parede	252-253	IMPERISO	200-201
DUDE para calha monofásica	540-541	FORZA para calha monofásica	540-541	INCA	408-409
DUDE para calha trifásica	512-513	FORZA para calha trifásica	512-513	INDIGO suspenso	90-91
DUDE montado à superfície	300-301	FOX refletor exterior	692-693	INEZ	396-397
DUGME	302-303	FRISCO na parede	320-321	INTRO	480-481
DURANT na parede	660-661	FRISCO com suporte para mesa	324-325	IP-BOX	748-749
		FRISCO de mesa	358-359	IP-BOX para sensor G12755	750-751
		FRUTTI para calha trifásica	522-523	IPSO	410-411
		FRUTTI suspenso	34-35	IPSO fixo	410-411
E				IRIA embutida	468-469
EDIKA de pé	368-369	G		ISLA embutida	408-409
EDIKA de mesa	350-351	GAN na parede	242-243	ITAKA na parede	708-709
EIGHT suspensa para calha trifásica	524-525	GAP embutida	720-721		
EIGHT teto	116-117	GARBO de mesa	352-353	J	
EIGHT suspenso	52-53	GARDETTE de pé	366-367	JACK na parede	246-247
EILEEN teto	120-121	GARDETTE de mesa	350-351	JACK para calha trifásica	528-529
EKE na parede	320-321	GARDIEN vertical	640-641	JACK teto	128-129
EL DORADO suspenso	24-25	GARNISH para calha trifásica	526-527	JACK suspenso	52-53
EL PASO de mesa	344-345	GARNISH suspenso	50-51	JAKARANDA abajur	576-577
ELECTRA	412-413	GARRET na parede	634-635	JAMAICA suspenso	30-31
ELIA na parede	630-631	GARY com espigão	698-699	JAMES DIMM teto	150-151
ELIA de pé	630-631	GAVIN na parede	668-669	JERSEY na parede	234-235
ELICA exterior	470-471	GAYA	144-145	JOLI na parede	330-331
ELICA embutida	470-471	GERI na parede	678-679	JOLI de mesa	354-355
ELISA para calha monofásica	550-551	GIFT para calha trifásica	528-529	JULIETTA para calha monofásica	546-547
ELISA para calha trifásica	530-531	GIFT suspenso	54-55	JULIETTA para calha trifásica	524-525
ELISA conjunto suspenso	598-599	GIGI na parede	678-679	JULIETTA suspenso	48-49
ELISEO na parede	294-295	GINA parede	240-241		
ELISEO montado à superfície	294-295	GINA teto	126-127	K	
ELLA suspenso	36-37	GINO na parede	660-661	KANE na parede	676-677
ENCOMBRE suspenso	20-21	GIULIA suspenso	68-69	KARO abajur	570-571
ENKI	146-147	GLAMOUR suspenso	24-25	KATHARIS para tetos ocós	124-125
ENZO conjunto suspenso	600-601	GLOSSY	306-307	KAY embutida	426-427
EQUA	402-403	GLOSSY em braço articulado	306-307	KAYA na parede	324-325
ERGO embutida	428-429	GOLDIE suspenso	74-75	KEIG teto	648-649
ESICA teto	116-117			KEITH base de suporte com USB	612-613
ESME suspenso	34-35			KELLY DIMM na parede	310-311
				KELLY DIMM semi embutida	308-309
				KELLY DIMM teto	136-137

PUC fonte de luz	742-743	SHOW na parede	322-323	TRICA para calha monofásica	544-545	
PULIRE para calha monofásica	546-547	SID na parede	244-245	TRICA para calha trifásica	514-515	
PULIRE suspenso	42-43	SIENA na parede	316-317	TRIDENT corpo	92-93	
PURINA para calha monofásica	544-545	SIENA para calha monofásica	542-543	TRIDENT conjunto suspenso 2 pçs	92-93	
PURINA para calha trifásica	514-515	SILENCE na parede	234-235	TRIP na parede	262-263	
Q						
QUADRA teto	648-649	SINTRA para calha trifásica	520-521	TRIX conjunto suspenso	602-603	
QUO embutida	416-417	SINTRA suspenso	72-73	TUBA na parede	256-257	
R						
RADICAL suspenso	36-37	SIV superfície	680-681	TUBA teto	138-139	
RAGG embutida	480-481	SLENDER superfície	172-173	TUTTI para calha trifásica	522-523	
RALLONG base para teto	592-593	SLENDER embutida	464-465	TUTTI suspenso	34-35	
RALLONG base para teto suspenso	592-593	SNAZZY	134-135	TWIST na parede	270-271	
RARA suspenso	22-23	SOBER embutida	444-445	U		
RASQ embutido na parede	480-481	SOCORRO de superfície	172-173	UKKO na parede	268-269	
REDO direcional	334-335	SOCORRO embutida	462-463	V		
REEM na parede	260-261	SOLO base de teto	602-603	VADE	138-139	
RENO na parede	706-707	SONET na parede	636-637	VADIS na parede	634-635	
RENO de superfície	706-707	SONET vertical	636-637	VADIS vertical	634-635	
REWA fixa	428-429	SONNY teto	650-651	VALE na parede	320-321	
RIDICK Abajur	576-577	SONYA	650-651	VALTO na parede	222-223	
RIGA teto	136-137	SORANO na parede	642-643	VALTO de superfície	222-223	
RIGA suspenso	78-79	SORANO teto	642-643	VARIA de pé	372-373	
RINA na parede	640-641	SPARKLE embutida	428-429	VECINO na parede	668-669	
RINA de pé	640-641	SPECTACLE superfície	124-125	VENICE teto	112-113	
RINO capa decorativa	394-395	SPIDER conjunto suspensos	604-605	VERIA na parede	664-665	
RINO		SPIDER junta	604-605	VERITA na parede	242-243	
embutido sem tampa	394-395	SPLASH embutida	406-407	VERO embutida	404-405	
RIO embutida	472-473	SPRAY embutida	442-443	VERSA na parede	322-323	
RITZY de pé	364-365	STAMPATA abajur	568-569	VERSA parede com abajur	230-231	
RITZY de mesa	350-351	STRUCTURAL de superfície	190-191	VERSINA com abajur	230-231	
RIVIER teto	190-191	STRUCTURAL embutida	464-465	VESCO suspenso	30-31	
RIZZ	724-725	STRUCTURAL suspenso	88-89	VIENNA de superfície	252-253	
RODGE teto	122-123	SWAY casa de banho	200-201	VIP dobrar	444-445	
ROLO na parede	248-249	SWING topo de quadro	278-279	VIPER de mesa	356-357	
RON na parede	226-227	T			VIPER teto	66-67
RON abajur	580-581	TACO teto	154-155	VIRGO na parede	670-671	
ROSITA na parede	306-307	TAINA com abajur	232-233	VIRGO teto	130-131	
ROSITA de pé	372-373	TAMPA terminais 2 pçs	218-219	VOLTERA na parede	316-317	
ROSITA de mesa	354-355	TAMPA na parede sem terminais	218-219	W		
ROSS refletor exterior	700-701	TAPA na parede	260-261	WATERBOY	394-395	
ROSTAM na parede com USB	314-315	TAPIO na parede	318-319	WIM na parede	248-249	
ROZA na parede	260-261	TAPIO de mesa	356-357	WISH DIMM para calha monofásica	538-539	
S						
SAMMY teto	120-121	TARIS de superfície	652-653	WISH DIMM para calha trifásica	504-505	
SAMPO na parede	658-659	TECH fixa	446-447	WOODY base candeeiro de mesa	608-609	
SANSSOUCI para calha trifásica	526-527	TELO na parede	672-673	WOOP na parede	658-659	
SANSSOUCI suspenso	50-51	TEMPO abajur	586-587	X		
SARA teto	110-111	TERRA embutida	722-723	XYLO na parede	670-671	
SASSARI teto	110-111	TESS embutida	478-479	Y		
SAVOY para armários	204-205	THALIA na parede	316-317	YOLO acima de espelho	204-205	
SCOTT teto	652-653	TIARA na parede	232-233	Z		
SEGNO embutida	468-469	TICO na parede	272-273	ZACK	682-683	
SELENA na parede	228-229	TIM embutida	446-447	ZALA suspenso	22-23	
SELMA na parede	680-681	TIRAS na parede	656-657	ZANE na parede	688-689	
SEMPRE sensor teto	188-189	TITO DIMM na parede	254-255	ZARA teto	110-111	
SEMPRE teto	186-187	TITO na parede	254-255	ZAZA na parede	678-679	
SENSOR	750-751	TOLEDO	398-399	ZIZI embutida	432-433	
SENSOR acima do teto	750-751	TOMBA suspenso	52-53	ZUMA DIMM para calha trifásica	504-505	
SENSOR para encaixe numa luminária	750-751	TOMBOY	430-431	ZUMBA de mesa	344-345	
SENSOR para montagem em lâmpadas exteriores	750-751	TOPIC direcional	444-445	ZURI embutida	448-449	
SENSOR teto	750-751	TOPTOP	702-703	Z		
SENZA teto	118-119	TOPTOP solo	702-703			
SHARM embutida	388-389	TORINO na parede	264-265			
SHARP na parede	234-235	TORO na parede	250-251			
		TRAF0	748-749			
		TRAF0 DIMM	746-747			
		TRAX para calhas trifásicas	506-507			
		TREEZA vertical	638-639			
		TRICA na parede	304-305			

G11837	740-741	G13110	736-737	G13846	748-749	R10429	646-647	R10626	58-59	R11340	494-495
G11840	740-741	G13111	736-737	G13847	736-737	R10430	122-123	R10637	90-91		496-497
G11841	740-741	G13112	736-737	G13943	732-733		646-647	R10639	470-471	R11341	498-499
G11849	736-737	G13119	736-737	G13944	732-733	R10431	696-697		714-715	R11342	498-499
G11852	740-741	G13120	740-741	G13945	732-733	R10432	692-693	R10640	516-517	R11343	498-499
G11859	742-743	G13122	738-739	R10119	148-149	R10433	638-639	R10641	516-517	R11344	498-499
G11860	742-743	G13123	736-737	R10120	148-149	R10436	724-725	R10644	516-517	R11345	498-499
G11861	742-743	G13124	746-747	R10122	152-153	R10437	658-659	R10645	516-517	R11346	494-495
G11862	742-743	G13125	746-747	R10123	152-153	R10438	658-659	R11169	664-665		496-497
G11867	582-583	G13147	742-743	R10124	142-143	R10439	658-659	R11170	636-637	R11347	494-495
	584-585	G13148	742-743	R10129	258-259	R10441	638-639	R11171	636-637		496-497
G11868	580-581	G13149	742-743	R10132	258-259	R10444	418-419	R11281	172-173	R11348	494-495
	584-585	G13150	734-735		688-689	R10445	246-247	R11284	172-173		496-497
G11869	580-581	G13151	736-737	R10133	258-259	R10446	248-249	R11285	172-173	R11349	494-495
G11870	586-587	G13152	734-735	R10133	688-689	R10448	250-251	R11290	178-179		496-497
G11871	586-587	G13154	734-735	R10148	438-439	R10449	250-251	R11291	86-87	R11350	494-495
G12065	740-741	G13155	734-735	R10164	152-153	R10451	244-245	R11292	86-87		496-497
G12067	742-743	G13185	742-743	R10166	122-123	R10454	130-131	R11296	158-159	R11351	494-495
G12068	742-743	G13306	736-737	R10167	152-153	R10455	250-251	R11297	158-159		496-497
G12206	740-741	G13307	736-737		334-335	R10465	248-249	R11299	178-179	R11352	494-495
G12207	740-741	G13308	734-735	R10168	146-147	R10478	46-47	R11300	494-495		496-497
G12209	742-743	G13309	734-735	R10170	258-259	R10479	46-47		496-497	R11353	494-495
G12232	740-741	G13310	734-735		688-689	R10491	220-221	R11301	494-495		496-497
G12233	740-741	G13311	734-735	R10171	152-153	R10492	116-117		496-497	R11354	494-495
G12234	740-741	G13406	740-741		334-335	R10493	52-53	R11302	494-495		496-497
G12237	736-737	G13407	740-741	R10173	334-335	R10498	158-159		496-497	R11355	494-495
G12243	736-737	G13453	736-737	R10178	272-273	R10500	108-109	R11303	494-495		496-497
G12244	734-735	G13454	736-737	R10195	140-141	R10501	52-53		496-497	R11356	494-495
G12245	734-735	G13455	736-737	R10196	148-149	R10506	18-19	R11304	494-495		496-497
G12246	734-735	G13456	738-739	R10197	266-267	R10509	50-51		496-497	R11357	498-499
G12251	742-743	G13457	736-737	R10204	438-439	R10510	54-55	R11305	494-495	R11358	494-495
G12299	582-583	G13458	734-735	R10212	140-141	R10511	50-51		496-497		496-497
	584-585	G13459	734-735	R10213	148-149	R10513	16-17	R11306	498-499	R11359	496-497
G12300	580-581	G13460	734-735	R10216	438-439	R10515	70-71	R11307	494-495		498-499
	584-585	G13461	734-735	R10217	438-439	R10516	18-19		496-497	R11360	494-495
G12340	742-743	G13462	734-735	R10218	438-439	R10517	18-19	R11308	494-495		496-497
G12366	556-557	G13464	738-739	R10219	448-449	R10518	18-19		496-497	R11361	494-495
G12367	556-557	G13465	740-741	R10239	190-191	R10519	354-355	R11309	494-495		496-497
G12368	556-557	G13466	740-741		276-277	R10520	374-375		496-497	R11362	494-495
G12369	556-557	G13467	738-739	R10251	616-617	R10521	332-333	R11310	498-499		496-497
G12370	556-557	G13468	738-739	R10252	616-617	R10522	58-59	R11311	494-495	R11365	226-227
G12371	556-557	G13469	742-743	R10253	616-617	R10527	698-699		496-497	R11368	226-227
G12372	556-557	G13470	742-743	R10254	616-617	R10530	696-697	R11312	494-495	R11370	572-573
G12373	556-557	G13477	736-737	R10262	208-209	R10532	722-723		496-497	R11371	572-573
G12374	556-557	G13478	738-739	R10263	208-209	R10536	30-31	R11313	494-495	R11372	572-573
G12375	556-557	G13518	734-735	R10264	208-209	R10538	322-323		496-497	R11377	226-227
G12376	556-557	G13528	750-751	R10265	208-209	R10539	28-29	R11314	494-495	R11381	226-227
G12377	556-557	G13545	728-729	R10266	244-245	R10540	28-29		496-497	R11383	226-227
G12378	556-557	G13546	728-729	R10269	422-423	R10541	320-321	R11315	494-495	R11455	582-583
G12582	748-749	G13547	728-729	R10270	422-423	R10542	306-307		496-497	R11461	584-585
G12723	740-741	G13572	736-737	R10271	420-421	R10543	306-307	R11316	494-495	R11462	580-581
G12724	740-741	G13573	734-735	R10272	424-425	R10545	720-721		496-497	R11463	580-581
G12725	740-741	G13574	738-739	R10304	426-427	R10546	720-721	R11317	494-495	R11464	226-227
G12726	740-741	G13575	738-739	R10325	148-149	R10547	634-635		496-497	R11465	582-583
G12752	750-751	G13576	738-739	R10326	148-149	R10548	634-635	R11318	494-495	R11466	570-571
G12753	750-751	G13577	730-731	R10351	668-669	R10552	652-653		496-497	R11467	570-571
G12754	750-751	G13578	730-731	R10352	686-687	R10553	644-645	R11319	494-495	R11468	572-573
G12755	750-751	G13579	730-731	R10353	686-687	R10554	672-673		496-497	R11469	572-573
G12756	750-751	G13581	734-735	R10354	686-687	R10555	722-723	R11320	494-495	R11470	570-571
G12757	750-751	G13655	740-741	R10355	686-687	R10557	720-721		496-497	R11471	588-589
G12758	750-751	G13656	740-741	R10356	686-687	R10558	474-475	R11321	494-495	R11472	588-589
G12759	750-751	G13657	740-741	R10361	650-651	R10558	712-713		496-497	R11473	590-591
G12983	748-749	G13670	92-93	R10362	650-651	R10561	428-429	R11322	494-495	R11474	590-591
G12984	748-749		190-191	R10363	650-651	R10564	516-517		496-497	R11475	586-587
G12985	734-735	G13671	92-93	R10364	690-691	R10565	398-399	R11323	494-495	R11476	586-587
G13002	746-747		190-191	R10365	690-691	R10566	398-399		496-497	R11477	584-585
G13003	746-747	G13672	92-93	R10366	690-691	R10572	396-397	R11324	494-495	R11478	584-585
G13004	746-747	G13700	730-731	R10367	638-639	R10573	406-407		496-497	R11479	580-581
G13006	748-749	G13705	740-741	R10368	638-639	R10574	406-407	R11325	494-495	R11480	580-581
G13008	746-747	G13706	740-741	R10372	628-629	R10576	108-109		496-497	R11481	582-583
G13009	748-749	G13715	738-739	R10374	140-141	R10578	70-71	R11326	494-495	R11482	570-571
G13013	734-735	G13722	740-741	R10375	140-141	R10580	230-231		496-497	R11483	570-571
G13014	736-737	G13723	740-741	R10379	708-709		312-313	R11327	494-495	R11484	588-589
G13015	736-737	G13724	740-741	R10380	638-639	R10581	84-85		496-497	R11485	588-589
G13020	742-743	G13725	736-737	R10382	650-651	R10582	178-179	R11328	494-495	R11486	590-591
G13021	734-735	G13728	730-731	R10383	650-651	R10584	86-87		496-497	R11487	590-591
G13022	734-735	G13749	94-95	R10384	672-673	R10586	396-397	R11329	494-495	R11488	586-587
G13023	734-735	G13750	94-95	R10385	648-649	R10587	396-397		496-497	R11489	586-587
G13024	734-735	G13751	94-95	R10386	648-649	R10588	204-205	R11330	494-495	R11490	580-581
G13026	736-737	G13798	554-555	R10387	660-661	R10591	332-333		496-497	R11491	580-581
G13027	736-737	G13799	554-555	R10388	692-693	R10598	480-481	R11331	494-495	R11492	226-227
G13028	736-737	G13800	552-553	R10395	404-405	R10602	322-323		496-497	R11493	582-583
G13029	736-737	G13801	552-553	R10395/12	404-405	R10604	306-307	R11332	494-495	R11494	570-571
G13032	742-743		554-555	R10398	678-679	R10605	28-29		496-497	R11495	570-571
G13033	742-743	G13802	552-553	R10399	678-679	R10606	480-481	R11333	494-495	R11496	572-573
G13034	738-739		554-555	R10400	262-263	R10608	358-359		496-497	R11497	572-573
G13035	738-739	G13803	552-553	R10401	260-261	R10612	202-203	R11334	494-495	R11498	572-573
G13036	738-739		554-555	R10402	446-447	R10613	202-203		496-497	R11499	570-571
G13037	738-739	G13804	552-553	R10404	446-447	R10614	202-203	R11335	494-495	R11500	588-589
G13038	738-739		554-555	R10407	404-405	R10615	602-603		496-497	R11501	588-589
G13040	740-741	G13806	746-747	R10418	426-427	R10616	600-601	R11336	494-495	R11502	590-591
G13041	740-741	G13820	552-553	R10419	426-427	R10617	600-601		496-497	R11503	590-591
G13043	738-739	G13828	738-739	R10420	442-443	R10618	600-601	R11337	494-495	R11504	226-227
G13044	738-739	G13830	738-739	R10421	428-429	R10620	28-2				

R11510	582-583	R11706	16-17	R11881	598-599	R11998	212-213	R12188	464-465	R12291	534-535
R11511	590-591	R11707	72-73	R11882	598-599	R12006	514-515	R12195	106-107	R12292	532-533
R11512	226-227	R11715	46-47	R11883	598-599	R12007	514-515	R12196	108-109	R12293	534-535
R11513	586-587	R11723	516-517	R11884	598-599	R12009	446-447	R12197	108-109	R12293	532-533
R11514	586-587	R11724	516-517	R11885	598-599	R12010	678-679	R12198	116-117	R12294	534-535
R11515	584-585	R11725	394-395	R11886	598-599	R12011	664-665	R12199	116-117	R12294	532-533
R11516	584-585	R11726	394-395	R11887	598-599	R12012	690-691	R12201	108-109	R12295	534-535
R11517	580-581	R11727	394-395	R11888	598-599	R12013	478-479	R12202	108-109	R12295	532-533
R11518	580-581	R11728	394-395	R11889	598-599	R12014	714-715	R12214	616-617	R12296	534-535
R11519	226-227	R11729	394-395	R11890	598-599	R12014	478-479	R12216	616-617	R12296	532-533
R11520	582-583	R11730	394-395	R11891	598-599	R12015	714-715	R12217	616-617	R12296	534-535
R11522	226-227	R11731	444-445	R11892	598-599	R12015	478-479	R12218	210-211	R12297	532-533
R11523	586-587	R11732	448-449	R11893	598-599	R12018	714-715	R12219	210-211	R12297	534-535
R11524	586-587	R11733	406-407	R11894	598-599	R12018	664-665	R12220	216-217	R12298	532-533
R11535	584-585	R11734	406-407	R11895	598-599	R12021	684-685	R12222	616-617	R12298	534-535
R11540	582-583	R11735	406-407	R11896	598-599	R12022	682-683	R12223	616-617	R12305	514-515
R11541	590-591	R11736	406-407	R11897	598-599	R12022	474-475	R12224	616-617	R12306	514-515
R11542	586-587	R11738	444-445	R11898	598-599	R12024	712-713	R12225	616-617	R12307	514-515
R11543	586-587	R11740	394-395	R11899	598-599	R12025	698-699	R12226	616-617	R12308	544-545
R11544	584-585	R11741	394-395	R11900	598-599	R12027	682-683	R12227	616-617	R12309	544-545
R11545	584-585	R11742	444-445	R11901	598-599	R12028	684-685	R12228	616-617	R12310	544-545
R11546	580-581	R11743	444-445	R11902	598-599	R12029	474-475	R12229	616-617	R12311	514-515
R11547	580-581	R11744	448-449	R11903	598-599	R12029	712-713	R12230	616-617	R12312	514-515
R11548	226-227	R11745	448-449	R11904	598-599	R12030	474-475	R12254	532-533	R12313	514-515
R11549	582-583	R11746	444-445	R11905	598-599	R12033	712-713	R12255	534-535	R12314	544-545
R11550	590-591	R11751	702-703	R11906	598-599	R12033	332-333	R12255	532-533	R12316	544-545
R11551	586-587	R11752	264-265	R11907	598-599	R12033	692-693	R12255	534-535	R12317	514-515
R11552	586-587		668-669	R11908	598-599	R12036	246-247	R12256	532-533	R12318	514-515
R11553	584-585	R11753	692-693	R11909	596-597	R12037	420-421	R12256	534-535	R12319	514-515
R11554	584-585		700-701	R11910	596-597	R12038	424-425	R12257	532-533	R12320	544-545
R11555	580-581	R11754	700-701	R11911	596-597	R12039	242-243	R12258	534-535	R12321	544-545
R11556	580-581	R11755	700-701	R11912	596-597	R12040	346-347	R12258	532-533	R12322	544-545
R11557	226-227		702-703	R11913	596-597	R12041	614-615	R12259	534-535	R12332	308-309
R11558	582-583	R11756	50-51	R11914	596-597	R12043	142-143	R12259	532-533	R12333	308-309
R11559	590-591	R11758	322-323	R11915	596-597	R12044	142-143	R12260	534-535	R12334	308-309
R11560	226-227	R11759	356-357	R11916	596-597	R12045	410-411	R12260	532-533	R12335	308-309
R11561	586-587	R11761	16-17	R11917	596-597	R12046	410-411	R12261	534-535	R12336	308-309
R11562	586-587	R11765	76-77	R11918	596-597	R12047	142-143	R12261	532-533	R12337	308-309
R11563	584-585	R11766	76-77	R11919	596-597	R12048	108-109	R12262	534-535	R12338	516-517
R11564	584-585	R11768	516-517	R11920	596-597	R12049	508-509	R12262	532-533	R12339	516-517
R11565	580-581	R11769	516-517	R11922	596-597	R12050	412-413	R12263	534-535	R12350	472-473
R11566	580-581	R11770	140-141	R11923	596-597	R12051	412-413	R12263	532-533	R12354	126-127
R11567	226-227	R11771	140-141	R11924	596-597	R12052	412-413	R12264	534-535	R12355	416-417
R11568	582-583	R11772	134-135	R11925	596-597	R12053	412-413	R12264	532-533	R12356	418-419
R11569	590-591		328-329	R11926	596-597	R12054	66-67	R12265	534-535	R12357	414-415
R11570	226-227	R11773	134-135	R11927	596-597	R12055	40-41	R12265	532-533	R12358	420-421
R11573	580-581		328-329	R11929	596-597	R12056	40-41	R12266	534-535	R12359	424-425
R11574	580-581	R11774	592-593	R11930	596-597	R12057	70-71	R12266	532-533	R12360	416-417
R11575	226-227	R11775	592-593	R11931	596-597	R12059	508-509	R12267	534-535	R12361	414-415
R11576	582-583	R11776	592-593	R11932	596-597	R12060	508-509	R12267	532-533	R12362	414-415
R11577	570-571	R11777	592-593	R11933	596-597	R12061	466-467	R12268	534-535	R12363	416-417
R11578	570-571	R11778	594-595	R11934	596-597	R12062	464-465	R12268	532-533	R12365	242-243
R11579	572-573	R11779	594-595	R11935	596-597	R12063	180-181	R12269	534-535	R12379	340-341
R11580	572-573	R11780	594-595	R11936	596-597	R12064	190-191	R12269	532-533	R12380	36-37
R11581	572-573	R11781	594-595	R11937	596-597	R12072	494-495	R12270	534-535	R12381	20-21
R11582	588-589	R11782	594-595	R11938	596-597	R12072	496-497	R12270	532-533	R12382	20-21
R11583	588-589	R11783	594-595	R11939	596-597	R12073	494-495	R12271	534-535	R12383	20-21
R11584	580-581	R11784	594-595	R11940	596-597	R12073	496-497	R12271	532-533	R12384	20-21
R11585	580-581	R11785	594-595	R11941	596-597	R12074	494-495	R12272	534-535	R12388	578-579
R11586	226-227	R11786	594-595	R11942	596-597	R12074	496-497	R12272	532-533	R12389	578-579
R11587	582-583	R11787	594-595	R11943	596-597	R12076	302-303	R12273	534-535	R12391	578-579
R11588	570-571	R11788	594-595	R11944	596-597	R12077	302-303	R12273	532-533	R12392	576-577
R11589	570-571	R11789	594-595	R11945	596-597	R12078	302-303	R12274	534-535	R12393	576-577
R11590	572-573	R11791	608-609	R11946	670-671	R12079	302-303	R12274	532-533	R12394	70-71
R11591	572-573	R11795	592-593	R11947	640-641	R12081	76-77	R12275	534-535	R12395	70-71
R11592	572-573	R11796	592-593	R11948	700-701	R12082	76-77	R12275	532-533	R12396	72-73
R11593	588-589	R11797	592-593	R11949	706-707	R12083	76-77	R12276	534-535	R12397	72-73
R11594	588-589	R11798	592-593	R11950	706-707	R12084	76-77	R12276	532-533	R12398	204-205
R11597	572-573	R11799	602-603	R11951	706-707	R12085	14-15	R12277	534-535	R12399	204-205
R11599	584-585	R11800	572-573	R11952	706-707	R12086	14-15	R12277	532-533	R12400	204-205
R11600	584-585	R11802	582-583	R11953	706-707	R12090	276-277	R12278	534-535	R12401	206-207
R11607	580-581	R11803	582-583	R11954	706-707	R12091	276-277	R12278	532-533	R12402	206-207
R11608	580-581	R11804	582-583	R11957	128-129	R12092	276-277	R12278	534-535	R12403	206-207
R11611	590-591	R11805	582-583	R11959	240-241	R12094	526-527	R12279	532-533	R12404	206-207
R11616	590-591	R11806	582-583	R11960	246-247	R12095	526-527	R12280	534-535	R12405	206-207
R11634	590-591	R11809	582-583	R11962	724-725	R12096	528-529	R12280	532-533	R12406	206-207
R11639	590-591	R11810	582-583	R11963	702-703	R12100	518-519	R12281	534-535	R12407	216-217
R11676	52-53	R11811	582-583	R11964	672-673	R12101	518-519	R12281	532-533	R12409	216-217
R11678	54-55	R11812	588-589	R11967	124-125	R12102	520-521	R12282	534-535	R12412	506-507
R11679	54-55	R11813	588-589	R11967	652-653	R12103	528-529	R12282	532-533	R12413	506-507
R11680	126-127	R11814	588-589	R11968	124-125	R12106	530-531	R12283	534-535	R12416	36-37
R11682	394-395	R11815	588-589	R11968	652-653	R12107	530-531	R12283	532-533	R12417	42-43
R11683	394-395	R11816	588-589	R11973	346-347	R12108	530-531	R12284	534-535	R12418	32-33
R11684	394-395	R11817	588-589	R11975	234-235	R12109	530-531	R12284	532-533	R12419	372-373
R11685	394-395	R11819	588-589	R11976	234-235	R12110	530-531	R12285	534-535	R12420	630-631
R11686	394-395	R11820	588-589	R11978	62-63	R12111	530-531	R12285	532-533	R12421	630-631
R11687	74-75	R11822	588-589	R11979	228-229	R12112	530-531	R12286	534-535	R12433	186-187
R11688	74-75	R11823	14-15	R11981	228-229	R12113	530-531	R12286	532-533	R12434	186-187
R11689	74-75	R11824	14-15	R11982	232-233	R12114	530-531	R12287	534-535	R12437	186-187
R11690	74-75	R11872	598-599	R11983	346-347	R12115	170-171	R12287	532-533	R12439	186-187
R11691	74-75	R11873	598-599	R11984	368-369	R12118	84				

R12449	136-137	R12540	708-709	R12633	136-137	R12760	454-455	R12884	452-453	R13056	456-457
R12450	136-137	R12541	272-273	R12634	136-137	R12761	454-455	R12885	452-453	R13058	456-457
R12451	136-137	R12542	708-709	R12635	430-431	R12762	454-455	R12886	452-453	R13059	456-457
R12452	136-137	R12543	272-273	R12636	430-431	R12763	454-455	R12887	452-453	R13060	456-457
R12453	136-137	R12544	708-709	R12637	308-309	R12764	454-455	R12888	452-453	R13061	456-457
R12454	136-137	R12545	272-273	R12638	430-431	R12765	454-455	R12889	452-453	R13062	456-457
R12455	136-137	R12546	708-709	R12639	308-309	R12766	454-455	R12890	452-453	R13063	460-461
R12456	78-79	R12547	272-273	R12640	430-431	R12767	454-455	R12891	156-157	R13064	460-461
R12457	78-79	R12548	708-709	R12641	208-209	R12768	454-455	R12892	322-323	R13065	460-461
R12458	78-79	R12549	272-273	R12642	208-209	R12769	454-455	R12893	322-323	R13066	460-461
R12459	78-79	R12550	708-709	R12643	208-209	R12770	454-455	R12894	324-325	R13067	460-461
R12460	66-67	R12551	272-273	R12644	238-239	R12771	454-455	R12900	414-415	R13068	460-461
R12461	318-319	R12552	708-709	R12645	238-239	R12772	454-455	R12901	220-221	R13069	460-461
R12462	356-357	R12553	634-635	R12646	606-607	R12773	454-455	R12902	282-283	R13070	460-461
R12463	374-375	R12554	252-253	R12647	472-473	R12774	454-455	R12903	220-221	R13071	460-461
R12464	348-349	R12555	654-655	R12648	472-473	R12775	458-459	R12904	282-283	R13072	460-461
R12465	348-349	R12556	664-665	R12649	408-409	R12776	458-459	R12905	218-219	R13073	168-169
R12466	370-371	R12557	266-267	R12650	408-409	R12777	458-459	R12906	282-283	R13074	168-169
R12467	370-371	R12558	686-687	R12651	408-409	R12778	458-459	R12907	218-219	R13075	168-169
R12468	370-371	R12559	266-267	R12652	394-395	R12779	458-459	R12908	282-283	R13076	168-169
R12470	370-371	R12560	686-687	R12653	722-723	R12780	458-459	R12909	218-219	R13077	168-169
R12471	154-155	R12561	686-687	R12654	430-431	R12781	458-459	R12910	218-219	R13078	168-169
R12473	318-319	R12562	266-267	R12655	42-43	R12782	458-459	R12911	218-219	R13079	168-169
R12474	356-357	R12563	686-687	R12656	42-43	R12783	458-459	R12912	218-219	R13080	168-169
R12475	374-375	R12564	254-255	R12657	350-351	R12784	458-459	R12913	218-219	R13081	168-169
R12476	316-317	R12565	674-675	R12658	368-369	R12785	458-459	R12914	218-219	R13082	168-169
R12477	60-61	R12566	674-675	R12659	144-145	R12786	458-459	R12915	218-219	R13083	184-185
R12478	60-61	R12567	660-661	R12660	144-145	R12787	458-459	R12916	218-219	R13084	184-185
R12479	62-63	R12568	666-667	R12661	144-145	R12788	458-459	R12917	218-219	R13085	184-185
R12480	236-237	R12569	666-667	R12662	138-139	R12789	458-459	R12918	218-219	R13086	184-185
R12481	234-235	R12570	666-667	R12663	134-135	R12790	458-459	R12919	218-219	R13087	184-185
R12482	236-237	R12571	670-671	R12664	146-147	R12791	458-459	R12920	218-219	R13088	184-185
R12483	32-33	R12572	662-663	R12665	146-147	R12792	458-459	R12921	218-219	R13089	184-185
R12484	350-351	R12573	662-663	R12666	366-367	R12793	458-459	R12922	218-219	R13090	184-185
R12485	366-367	R12574	662-663	R12667	366-367	R12794	458-459	R12923	218-219	R13091	184-185
R12486	350-351	R12575	662-663	R12668	352-353	R12795	458-459	R12924	218-219	R13104	310-311
R12487	364-365	R12576	662-663	R12669	90-91	R12796	458-459	R12925	218-219	R13105	310-311
R12488	350-351	R12577	664-665	R12670	268-269	R12797	458-459	R12926	218-219	R13107	310-311
R12489	366-367	R12578	660-661	R12671	268-269	R12798	458-459	R12927	218-219	R13108	310-311
R12490	154-155	R12579	660-661	R12672	262-263	R12799	458-459	R12928	218-219	R13109	310-311
R12492	130-131	R12580	690-691	R12673	262-263	R12800	458-459	R12929	218-219	R13113	574-575
R12493	80-81	R12581	690-691	R12674	144-145	R12801	458-459	R12930	218-219		
R12494	80-81	R12582	690-691	R12675	144-145	R12802	458-459	R12931	218-219	R13114	574-575
R12495	80-81	R12583	690-691	R12676	144-145	R12803	458-459	R12932	218-219		
R12496	80-81	R12584	690-691	R12677	144-145	R12804	458-459	R12933	218-219	R13126	416-417
R12497	132-133	R12585	690-691	R12678	144-145	R12805	458-459	R12934	218-219	R13127	456-457
R12498	326-327	R12574	478-479	R12679	144-145	R12806	458-459	R12935	218-219	R13128	456-457
R12499	132-133	R12575	714-715	R12680	144-145	R12807	458-459	R12936	218-219	R13129	456-457
R12500	326-327	R12576	478-479	R12681	144-145	R12808	458-459	R12937	218-219	R13130	456-457
R12501	132-133	R12577	714-715	R12682	144-145	R12809	458-459	R12938	218-219	R13131	456-457
R12502	326-327	R12578	478-479	R12683	144-145	R12810	458-459	R12939	218-219	R13132	460-461
R12503	296-297	R12579	714-715	R12684	144-145	R12811	458-459	R12940	218-219	R13133	460-461
R12504	296-297	R12580	694-695	R12685	144-145	R12812	458-459	R12941	218-219	R13134	460-461
R12505	296-297	R12581	696-697	R12686	474-475	R12813	458-459	R12942	218-219	R13135	460-461
R12506	296-297	R12582	698-699	R12687	712-713	R12814	458-459	R12943	218-219	R13136	460-461
R12507	306-307	R12583	206-207	R12688	474-475	R12815	458-459	R12944	218-219	R13137	460-461
R12508	306-307	R12584	602-603	R12689	712-713	R12816	458-459	R12945	218-219	R13138	460-461
R12509	306-307	R12585	602-603	R12690	470-471	R12817	458-459	R12946	218-219	R13139	460-461
R12510	306-307	R12586	602-603	R12691	470-471	R12818	458-459	R12947	218-219	R13140	460-461
R12511	354-355	R12587	256-257	R12692	470-471	R12819	458-459	R12948	218-219	R13141	460-461
R12512	354-355	R12588	682-683	R12693	470-471	R12820	458-459	R12949	218-219	R13142	460-461
R12513	372-373	R12589	256-257	R12694	470-471	R12821	458-459	R12950	218-219	R13143	460-461
R12514	372-373	R12590	682-683	R12695	470-471	R12822	458-459	R12951	218-219	R13144	460-461
R12515	640-641	R12591	264-265	R12696	470-471	R12823	458-459	R12952	218-219	R13145	460-461
R12516	142-143	R12592	264-265	R12697	470-471	R12824	458-459	R12953	218-219	R13146	460-461
R12517	142-143	R12593	252-253	R12698	470-471	R12825	458-459	R12954	218-219	R13147	460-461
R12524	124-125	R12594	262-263	R12699	470-471	R12826	458-459	R12955	218-219	R13148	460-461
R12525	652-653	R12595	262-263	R12700	470-471	R12827	458-459	R12956	218-219	R13149	460-461
R12527	410-411	R12596	262-263	R12701	470-471	R12828	458-459	R12957	218-219	R13150	460-461
R12528	470-471	R12597	262-263	R12702	470-471	R12829	458-459	R12958	218-219	R13151	460-461
R12529	712-713	R12598	262-263	R12703	470-471	R12830	458-459	R12959	218-219	R13152	460-461
R12530	470-471	R12599	262-263	R12704	470-471	R12831	458-459	R12960	218-219	R13153	460-461
R12531	714-715	R12600	254-255	R12705	470-471	R12832	458-459	R12961	218-219	R13154	460-461
R12532	484-485	R12601	674-675	R12706	470-471	R12833	458-459	R12962	218-219	R13155	460-461
R12533	718-719	R12602	256-257	R12707	470-471	R12834	458-459	R12963	218-219	R13156	460-461
R12534	484-485	R12603	272-273	R12708	470-471	R12835	458-459	R12964	218-219	R13157	460-461
R12535	482-483	R12604	272-273	R12709	470-471	R12836	458-459	R12965	218-219	R13158	460-461
R12536	716-717	R12605	272-273	R12710	470-471	R12837	458-459	R12966	218-219	R13159	460-461
R12537	482-483	R12606	272-273	R12711	470-471	R12838	458-459	R12967	218-219	R13160	460-461
R12538	716-717	R12607	272-273	R12712	470-471	R12839	458-459	R12968	218-219	R13161	460-461
R12539	482-483	R12608	272-273	R12713	470-471	R12840	458-459	R12969	218-219	R13162	460-461
R12540	716-717	R12609	272-273	R12714	470-471	R12841	458-459	R12970	218-219	R13163	460-461
R12541	482-483	R12610	272-273	R12715	470-471	R12842	458-459	R12971	218-219	R13164	460-461
R12542	716-717	R12611	272-273	R12716	470-471	R12843	458-459	R12972	218-219	R13165	460-461
R12543	482-483	R12612	272-273	R12717	470-471	R12844	458-459	R12973	218-219	R13166	460-461
R12544	716-717	R12613	272-273	R12718	470-471	R12845	458-459	R12974	218-219	R13167	460-461
R12545	482-483	R12614	272-273	R12719	470-471	R12846	458-459	R12975	218-219	R13168	460-461
R12546	716-717	R12615	272-273	R12720	470-471	R12847	458-459	R12976	218-219	R13169	460-461
R12547	482-483	R12616	272-273	R12721	470-471	R12848	458-459	R12977	218-219	R13170	460-461
R12548	716-717	R12617	272-273	R12722	470-471	R12849	458-459	R12978	218-219	R13171	460-461
R12549	482-483	R12618	272-273	R12723	470-471	R12850</					

R13226	388-389	R13349	510-511	R13499	510-511	R13619	658-659	R13720	548-549	R13861	546-547
R13227	388-389	R13350	540-541	R13500	510-511	R13620	480-481	R13721	522-523	R13862	548-549
R13228	388-389	R13351	540-541	R13501	136-137		716-717	R13726	550-551	R13863	548-549
R13229	388-389	R13352	512-513	R13502	680-681	R13621	480-481	R13730	170-171	R13864	558-559
R13230	388-389	R13353	512-513	R13503	122-123		716-717	R13731	500-501	R13865	558-559
R13231	388-389	R13359	24-25		648-649	R13622	118-119	R13732	500-501	R13866	558-559
R13232	388-389	R13360	30-31	R13504	666-667		646-647	R13735	214-215	R13867	134-135
R13233	388-389	R13361	150-151	R13505	122-123	R13623	118-119		280-281	R13867	328-329
R13234	388-389	R13362	150-151		642-643		646-647	R13736	254-255	R13868	134-135
R13235	390-391	R13363	132-133	R13506	122-123	R13624	118-119		674-675		328-329
R13236	390-391		326-327		642-643		648-649	R13737	254-255	R13869	134-135
R13237	390-391	R13364	132-133	R13507	122-123	R13625	118-119		674-675		328-329
R13238	390-391		326-327		642-643		648-649	R13738	254-255	R13870	542-543
R13239	390-391	R13365	80-81	R13508	642-643	R13626	118-119		674-675	R13871	542-543
R13240	390-391	R13366	80-81	R13509	642-643		646-647	R13739	254-255	R13872	542-543
R13241	390-391	R13367	540-541	R13510	122-123	R13627	118-119		674-675	R13873	510-511
R13242	390-391	R13368	512-513		648-649		646-647	R13742	106-107	R13874	510-511
R13243	390-391	R13369	540-541	R13511	122-123	R13628	118-119	R13743	164-165	R13875	510-511
R13244	390-391	R13370	512-513		648-649		648-649	R13745	44-45	R13876	134-135
R13245	390-391	R13371	304-305	R13512	670-671	R13629	118-119	R13746	44-45		328-329
R13246	390-391	R13372	304-305	R13513	680-681		648-649	R13747	44-45		510-511
R13247	390-391	R13373	304-305	R13514	680-681	R13630	696-697	R13748	26-27		542-543
R13248	390-391	R13374	304-305	R13515	680-681	R13631	648-649	R13752	48-49	R13877	134-135
R13249	390-391	R13375	304-305	R13520	240-241	R13632	648-649	R13753	48-49		328-329
R13250	392-393	R13376	304-305	R13521	400-401	R13633	642-643	R13754	106-107		510-511
R13251	392-393	R13377	224-225	R13522	400-401	R13634	642-643	R13755	644-645		542-543
R13252	392-393		292-293	R13524	574-575	R13635	632-633	R13756	668-669	R13878	536-537
R13253	392-393	R13378	224-225	R13526	574-575	R13636	632-633	R13757	682-683	R13879	536-537
R13254	392-393		292-293	R13527	658-659	R13637	632-633	R13758	640-641	R13880	536-537
R13255	392-393	R13379	224-225	R13529	504-505	R13638	632-633	R13759	542-543	R13881	536-537
R13256	392-393		292-293	R13531	504-505	R13639	612-613	R13760	542-543	R13882	502-503
R13257	392-393	R13380	224-225	R13535	516-517	R13640	612-613	R13761	316-317	R13883	502-503
R13258	392-393		292-293	R13537	516-517	R13641	658-659	R13762	316-317	R13884	502-503
R13259	392-393	R13383	560-561	R13538	120-121	R13642	110-111	R13763	316-317	R13885	502-503
R13260	392-393	R13385	560-561	R13539	120-121	R13643	644-645	R13764	316-317	R13886	502-503
R13261	392-393	R13386	560-561	R13542	120-121	R13644	318-319	R13765	316-317	R13887	502-503
R13262	392-393	R13390	448-449	R13551	164-165	R13645	318-319	R13767	542-543	R13888	214-215
R13263	392-393	R13391	448-449	R13552	134-135	R13646	318-319	R13769	538-539	R13889	214-215
R13264	392-393	R13394	364-365	R13554	202-203	R13647	320-321	R13770	538-539	R13890	314-315
R13267	176-177	R13395	368-369		280-281	R13648	320-321	R13771	538-539	R13891	14-15
R13268	176-177	R13397	30-31	R13555	200-201	R13649	314-315	R13772	538-539	R13892	38-39
R13271	24-25	R13398	26-27		280-281	R13650	32-33	R13773	504-505	R13893	330-331
R13274	348-349	R13401	454-455	R13556	330-331	R13651	228-229	R13774	504-505	R13894	330-331
R13275	24-25	R13402	454-455	R13558	354-355	R13652	40-41	R13775	504-505	R13895	330-331
R13276	34-35	R13404	166-167	R13559	680-681	R13653	364-365	R13776	504-505	R13896	330-331
R13278	568-569	R13405	166-167	R13560	680-681	R13654	640-641	R13777	80-81	R13897	14-15
R13279	568-569	R13417	576-577	R13561	678-679	R13658	40-41	R13778	80-81	R13898	14-15
R13280	30-31	R13418	26-27	R13562	260-261	R13660	372-373	R13779	326-327	R13899	14-15
R13281	568-569	R13419	26-27		668-669	R13661	230-231	R13780	326-327	R13900	14-15
R13282	238-239	R13423	318-319	R13563	656-657		312-313	R13781	536-537	R13901	330-331
R13283	352-353	R13429	356-357	R13564	656-657	R13662	230-231	R13782	536-537	R13902	330-331
R13284	234-235	R13430	400-401	R13565	656-657		312-313	R13783	504-505	R13903	352-353
R13284	606-607	R13432	400-401	R13566	468-469	R13663	346-347	R13784	504-505	R13904	352-353
R13285	20-21	R13433	240-241		720-721	R13664	346-347	R13788	36-37	R13905	352-353
R13288	410-411	R13435	242-243	R13567	468-469	R13665	366-367	R13789	126-127	R13906	352-353
R13289	34-35	R13436	248-249		720-721	R13666	366-367	R13790	128-129	R13907	342-343
R13290	34-35	R13437	612-613	R13568	698-699	R13667	398-399	R13791	126-127	R13908	68-69
R13293	340-341	R13438	130-131	R13569	656-657	R13668	398-399	R13792	240-241	R13909	68-69
R13294	340-341	R13439	724-725	R13570	164-165	R13676	104-105		676-677	R13910	68-69
R13295	340-341	R13441	456-457	R13571	314-315	R13677	104-105	R13793	676-677	R13911	68-69
R13296	38-39	R13442	456-457	R13582	450-451	R13678	104-105	R13794	676-677	R13912	68-69
R13297	38-39	R13444	168-169	R13583	450-451	R13679	104-105	R13795	130-131	R13913	68-69
R13298	36-37	R13445	168-169	R13584	450-451	R13680	106-107	R13796	644-645	R13914	294-295
R13300	442-443	R13446	538-539	R13585	450-451	R13681	106-107	R13797	644-645	R13915	294-295
R13302	442-443	R13448	568-569	R13586	450-451	R13682	112-113	R13807	154-155	R13916	294-295
R13303	610-611	R13449	344-345	R13587	450-451	R13683	112-113	R13808	154-155	R13917	294-295
R13304	610-611	R13450	120-121	R13588	450-451	R13684	112-113	R13809	614-615	R13918	300-301
R13315	22-23		646-647	R13589	450-451		156-157	R13814	522-523	R13919	300-301
R13316	22-23	R13451	120-121	R13590	450-451	R13685	112-113	R13815	526-527	R13920	300-301
R13319	22-23		646-647	R13591	450-451		156-157	R13816	528-529	R13921	300-301
R13320	344-345	R13452	120-121	R13598	404-405	R13686	110-111	R13817	522-523	R13922	300-301
R13321	22-23		646-647	R13599	404-405	R13687	110-111	R13818	522-523	R13923	300-301
R13322	342-343	R13471	138-139	R13600	404-405	R13688	110-111	R13819	518-519	R13924	300-301
R13323	342-343	R13472	138-139	R13601	404-405	R13689	114-115	R13821	56-57	R13925	300-301
R13324	342-343	R13473	138-139	R13602	396-397	R13690	114-115	R13822	56-57	R13926	540-541
R13325	342-343	R13474	138-139	R13603	408-409	R13691	222-223	R13823	56-57	R13927	540-541
R13328	82-83	R13475	138-139	R13604	402-403		290-291	R13824	42-43	R13928	512-513
	160-161	R13476	138-139	R13605	408-409	R13692	44-45	R13825	42-43	R13929	512-513
R13329	82-83	R13479	162-163	R13606	120-121	R13693	114-115	R13826	48-49	R13930	630-631</



 **rendl light studio**

www.rendl.pt